

WILLIAM LYNE

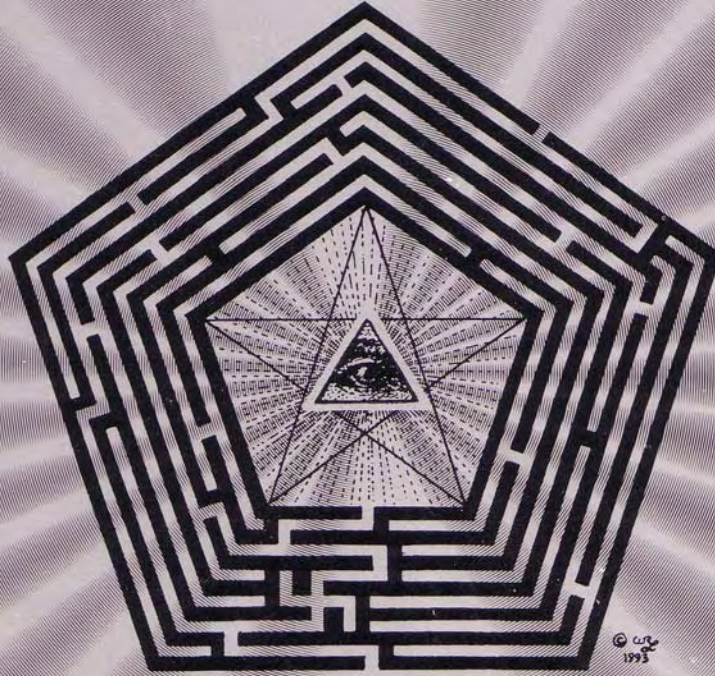

PENTAGON ALIENS

(Formerly Space Aliens From the Pentagon)

©William R. Lyne
1993, 1995, 1999

Creatopia Productions™
THIRD EDITION

Ab. Journal
10/27/91

The Roswell Incident

"UFO Crash at Roswell"

By Kevin D. Randle and Donald R. Schmitt

Avon Books, \$4.95, 327 pp.

Review by Fritz Thompson

When New Mexico rancher Mac Brazel rode out to check his livestock on the morning of July 3, 1947, what he found instead was wreckage oddly strewn across a pasture and a

that was believed to remain dormant
being called man's
an alien
it.



(Part of a newspaper review of a book on the "Roswell Incident")



Drawing by Roswell mortician Glenn Dennis, based on autopsy drawings

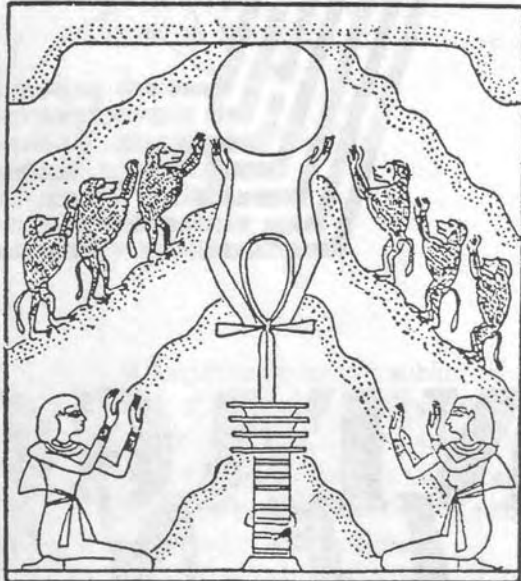

Baboons Saluting the Morning Sun

TABLE OF CONTENTS

PREFACE.....	v
INTRODUCTION	1
Verisimilitude.....	11
The Achilles's Heel of the Illuminati: "Ether Physics" and Flying Saucer Propulsion	14
I. The Most Rational Alternative	16
II. The O.S.I. Myth Factory	19
III. Gravity and Nikola Tesla's Work	20
IV. Dealing With "Equal and Opposite" Forces.....	24
V. A Comparison of Gravitational and Electrical Forces, As Applied to Flying Saucer Propulsion	25
VI. Momentum and Applied Force.....	26
VII. Energy and Time.....	27
VIII. Thor's Model T Coil.....	30
IX. Work and Energy.....	31
X. Forces and Fields.....	33
XI. Occult Ether Physics.....	37
A Brief History of Ether Physics	39
Application of the Hall Effect.....	40
The Precession Problem	44
SYNOPSIS OF FACTS	48

PART ONE: THE TECHNOLOGY52

CHAPTER I: Stage I Secret Gravity Secrets	52
Phony Research and Scientific Alzheimers.....	53
Inertia and Electromagnetism.....	54
Momentum and Inductance	56
Weightlessness, "p2", and the Tubes of Force.....	57
Nikola Tesla's Dynamic Theory of Gravity	61
"p2"	61
The Lorentz Force	64
The Atmosphere as a Cloud Chamber Experiment.....	64
Horizontal Flight	65

Chapter II: Pieces of the Puzzle Come Together	67
The Odyssey Begins	68
My First Daylight Sighting	71
I Meet the K.G.B. and Captain Mantell's Wingmate in the U.S. Air Force.....	78
I Meet the President's Brother-in-Law, and Arnold Schwarzenegger's Future Father-in-Law, in the Peace Corps.....	83
I Meet the CIA, Its Future Director, and the Future President of the U.S.A., While in the University	87
I Turn Down an Offer from the CIA to be "Once and Future King".....	88
In 1979 I Meet a Viejo from Pojoaque at the Flea Market, and Buy a WWII German Flying Saucer Navigation System from an Albuquerque Salvage Dealer..	89
Flying Submarines?	95
The Rocket Racket: Wernher von Braun, Willy Ley, Dr. Robert Goddard, and the Kreisel Teller-p2, in New Mexico and Peenemunde	101
I Meet Torquemada and the Medellin Cartel.....	103
I Meet a Member of the Trilateral Commission's International Geodetic Survey Team	109

CHAPTER III: I meet a Government M.I.B. in Santa Fe; Hollywood on the Take	112
"Looking for Motives"	115
Corny Government Special Effects and Hoax Scenarios: The Roswell Rhesus Monkey Hoax and Other Such Outrageous Shams	116
Phony Expert Consultants and Government Scripts	123
My "Friend", the M.I.B.....	127
Golden Cups, Monkey Business, and a Lot of Bull	147
The Roswell Hoax 'Saucer'.....	157
The Roswell Hoax 'Aliens'	158

CHAPTER IV: Sightings	159
Vicki Landrum, Et. Al	160
Radiation Dangers.....	165
The U.F.O. Cleaners	168
"Stars"	169
The Mind Cleaners	175
"Abductions": Travis Walton vs. Vicki Landrum.....	186
Tesla's "Flivver Machine"	194

CHAPTER V: How to Build a Flying Saucer.....	195
Author's Disclaimer	195
A. General Considerations.....	195
1. Size and Shape.....	196
2. Power System.....	197
3. High Voltage, D.C. Brush Discharge	199
4. High Voltage, High Frequency A.C. Current	200
5. Vertical Ascent and Descent.....	201
6. Horizontal Travel.....	201
B. Construction of the Hull.....	202
1. Power Plant	202
2. Seating and Visibility	202
3. Flight Suit.....	203
C. Simplified Drawings and Plans.....	203
1. (Special Supplementary Notations on the WW II German Flying Saucers).204	
2. The Two Basic Types of German Saucers:	209
"Flying Turtle" Drawing	210
3. Recent Notes Regarding American UFOs.....	212
4. My Flying Saucer Drawings and Plans	215
Preliminary Technical Background	215
The "Firefly"	217
"Electromagnetic Momentum"	218

PART TWO: THE SOCIAL MANIPULATION...219

CHAPTER VI: Cannibalistic Fascist Litigation	219
A. The Real Issues: The Wave of the Future	224
B. The Socialistic Bureaucracy: A Conspiracy Without Leaders	228
C. Traitor Judiciary	231
Game No. 1: The Ninth Amendment Quiet Game.....	232
A System in Contempt of Our Rights	233
Game No. 2: The Article One (Sec. 8, cl [8]) and Fifth and Fourteenth Amendments Property Game.....	235
Energy Slavery and Invention Theft	236
Triumvirate of Injustice.....	239
Game No. 3: The First Amendment End-Run Game (A.K.A. The Ol'Statute of Liberty Play).....	241
Credibility Roulette	241
D. American Dissident Trials, Murders, Tribulations, and Massacres	243
A Bird's Religion	257
The Kennedy Examples	258
The Historical Examples.....	262

CHAPTER VII: From the Easter Bunny to Auschwitz:	
The Religion of Einstein and the Nazi New-Agers	268
The "Modern Illuminati" and the Nazis	268
Einstein was a New-Ager	273
CHAPTER VIII: A Taste of Other Energy Secrets	278
Tesla's 'Special' Generator. How Does it Work?.....	283
CONCLUSION	287
Bibliography.....	290
Appendix A: Giving to the Public an Unlimited Right to Use of an Invention Heretofore Know as the Dyna-Lyne Universal Variable Pneumatic or Hydraulic Transmission System	293
Appendix B: The Joseph Papp Patent	297
Appendix C: Fabrication of Tesla's Single Terminal Coils	300
INDEX	302

PREFACE

I began writing this book in early 1992, with such urgency that I often began my day's writing at 4:00 A.M. Chapter I reflects my mood at the time. I believe there are matters addressed for the first time in this book—in 1993—which are important to your freedom and that of your loved ones.

The truth in this case requires exposing a conspiracy. The word "conspiracy" has been made a dirty word by those involved, like dogs under the table, knawing on a few bones and scraps thrown to them by those above, and growling at anyone who threatens their precarious security. Conspiracies exist, they are sometimes real, and real conspiracies can be harmful to those who pretend they don't exist.

This book will disappoint those who expects it to be filled with tales about little 'aliens', or about how I was abducted and used as a sex slave by giant Venusian females (or weird little alien guys who have 'implanted' me, or experimented with my sex organs, etc.). This book is about the "flying saucer"—sometimes called the "UFO"—what it really is, who invented it, and why our government still conceals it after over fifty years of use by it. I also explore the political, social, economic and historical context in which Big Brother has maintained a hoax of gigantic proportions, by lying to and brain washing the public, and oppressing intelligent witnesses, to conceal the saucer secrets from us, and why.

My "space aliens" are actually people, whose philosophy and bizarre masquerade are alien to the American way of life, since they believe in government by anti-democratic hoax, to maintain the secret power of the Trilateral Commission elite, to whom our lives are very cheap.

Some who read this may thoughtfully consider it and agree wholeheartedly, because it is reasonable, knowledgeable, logical and true. Others may be disconcerted and will read no further, avoiding the cold light of reason, preferring to continue believing Big Brother's fantastic lies. It takes courage to admit being duped. Some may be subscribers to The Skeptical Inquirer magazine, misplacing confidence in what Philip J. Klass... supposedly a "fellow skeptic"....says about those 'crazy believers' in "alien flying saucers and ghosts" (all in one breath, mind you). Read further, as there is more here for you. Still others will more vehemently dislike what I say, knowing it is true, because they are among the guilty CIA and NSA, etc. A small minority of the guilty may secretly like what I say, but be unable to break the "national insecurity" bonds which hold them rigidly in place, being forced to continue to lie to their fellow humans. Still others are beyond reason or any human sentiment, being motivated blindly by money, power, and a desire to "hold onto what they have". These are the "ruling class". Their fear of the truth is very real, and commitment to continued concealment total. The wealth they were born into is rooted in banking, minerals, chemical cartels which process

these, fuel companies, the pharmaceutical industry, banking, automotive or aeronautical manufacturing or transportation...planes, ships, trucks, and trains...anything the general public pays every day for. We are their 'captive' source of money and power.

There is one technology which more certainly than any other, has the capacity to drastically alter the Vested interests which sustain the elite, with its posh lifestyle, and even threatens to destroy it; electro-propulsive "flying saucer" technology.

It is not my desire to see anyone's honestly acquired economic security or prosperity ruined. It is my desire to see the collapse of whole empires, be they built on coercive monopoly, and fascist-state power, which exists at the expense of the freedom and well-being of innocent and productive people, gained and held by secrecy, extortion, force, theft, suppression and concealment of valuable, creative technology, which would also make our planet cleaner, more beautiful, and more accessible to everyone, and allow the peoples of the world to get to know and to appreciate each other more intimately and directly than ever before. No one, be they government, corporate, or individual, has the legitimate right or power to conceal such technology, unless they invented and created it, which they did not.

The existing state of apparently monolithic interests, while presently appearing to be held firmly in place by a chain of powerful government, financial, industrial, technical, military, judicial and law enforcement entities, cannot maintain themselves forever, and it is unrealistic to think that they can.

For those who are threatened by the public advent of this long-suppressed technology, here is the handwriting on the wall: **PREPARE FOR THE LIBERATION OF ELECTRO-PROPULSIVE TECHNOLOGY FROM THE HANDS OF THE SECRET GOVERNMENT, BY THE PUBLIC AT LARGE. CONSIDER ALL THE IMPLICATIONS, AND ACT ACCORDINGLY.**

The puppets...the "professionals" of pseudo-paranormalism and pseudo-skepticism...don't have so much to lose, and much more to gain. They can probably find more productive jobs selling insurance or used cars. Though they may not like sitting in the **COLD LIGHT OF REASON**, it will only hurt for a little while. It must be an uncomfortable and weird feeling to "lie for their country", which would not be so bad if that was all they were doing. There is nothing "patriotic" about corralling the minds of your fellow citizens with a fence of lies, so they can be "broke and branded" as the dupes of the **BIG LIARS**. The suppression of this technology is not in the national security interest.

Some who spread such lies harbor no patriotic delusions, enamoring themselves shamelessly to the covert money masters, performing like puppets, thoughtless and calloused. They will only come painfully alive when they face the music, once they are publically unmasked as professional liars for Big

Brother. I can hear the comments now: "...Oh...ya' mean ol' Joe there? Why he use ta' be one of them big-shot You-fologists, 'til it all come out that it wuz just a big lie to cover up gov'ment flyin' saucer stuff. Sad, ain't it?"

It is not difficult to imagine the strange mental processes involved in searching for a new way to present the same Old Tired Big Lies which saw their American premier at Roswell, New Mexico, in 1947, giving birth to the "Twin Lies"....that "aliens have landed" and that "flying saucers don't exist". This BIG LIE SYSTEM was. originally designed by the intelligence personnel of the Gestapo, the Reichsicherheithauptante VI ("National Security Agency Div. 6"), and the Roswell hoax and the drama which followed has a dualistic nature which is typical of the gnosticism which was the basis for the SS religion¹. Former SS intelligence agents at Alamogordo designed and initiated the Roswell hoax.

Yes, the two sides were Siamese twins, born of an SS father and CIA mother, representing two opposite sides of the same bogus wooden nickel, counterfeited in America as one of the first shams of the CIA under the fraudulently misnamed "National Security Act" of 1947, which was never submitted to Congress for its approval, because its authors—CFR bankers at Pratt House—knew it contained so many unconstitutional provisions and violations of American liberty and sovereignty, that they feared it would never be approved. (It "went into effect" like most illegitimate usurpations of rights and powers, through executive edict.)

The "Siamese Twins" born at Roswell were the two, diametrically opposite prongs of the Pentagon's concealment apparatus, UFOlogical Paranormalism and Skeptical Official Denial A more organized skeptical initiative was later mounted, as a 'civilian' adjunct to the official deniers, as the counterpart to UFOlogy. Both these fields were planned by the CIA and grew out of the ranks of the CIA's and Air Force Intelligence's plainclothes and covert agent contingencies. This also included such people as businessmen, university professors, astronomers, astrophysicists, meteorologists, other scientists, and aeronautical experts, many of whom were already affiliated with the government's secret projects. Many new press, magazine, book, and screen writers, producers and actors were soon on the payroll, to launch the "alien" scenario through the popular media. There were similar fabrications and concealments in academic areas and textbooks.

Since I originally wrote about the movie-UFOlogy-CIA connections in 1993, there have been many others who have copied me, and to my knowledge, none of them has given me any attribution whatsoever, though to my knowledge, I was the first to do so.

¹Jean-Michel Angebert, *The Occult and the Third Reich* (the mystical origins of Nazism and the search for the Holy Grail), McGraw -Hill Paperbacks (1975) p. 4.

Of the two counterparts, the UFOlogists seem to have it better than the "skeptics", who appear rather dull by comparison, but spice up their work only by criticizing and debunking their more interesting twin. There are more possibilities among the UFOlogy circles for exciting social, romantic, and sexual encounters, since they are a more interesting bunch of huxters, though an intelligent person soon finds himself longing for another rational being amongst them. To come up with more fascinating subject matter, the skeptics must set their hooks much deeper. Their magazines debunk some false and fraudulent shams—perhaps dangerous to one's mental or physical health, not to mention the pocketbook—only to add false credibility to their irrational denials that flying saucers exist. I can agree with most of the skeptic material, yet their CSICOP flying saucer psychopancy is inconsistent, which reminds me of Ayn Rand's statement: "There are no contradictions in reality; check your premises." The great contradictions in the skeptical arena, are based on false premises planted there by devious, manipulative, lying, CIA-employed pseudo-skeptics, which even many of the innocent true skeptics have failed to identify or to expunge, but they're easy to spot.

To allow these great contradictions to be proliferated in skeptic literature, as reasonable, logical and true, when a lie, poisons the whole arena, like a gangrene of reason, and makes fools of the 'skeptics', and a mockery of the whole movement. Did it ever occur to them that the publications and money behind it came from the CIA? As individuals who pride themselves as having truly ethical intellects, it should be an important part of the skeptic agenda to identify and drive out this "alien implant", which has been using them to carry out the CIA's campaign of lies for too long. It takes an outsider like me to tell them about it. The 21st century should be a "flying saucer economy".

The people who should appreciate this writing the most, are those who are inquisitive, truly skeptical, intelligent, reasonable, individualistic, creative, ethical, imaginative, scientific, and above all, excited and optimistic about the possibilities of opening up a new era in human history, where all mankind will enjoy the greatest invention man has ever conceived and built, the electro-propulsive flying machine generally known as the "UFO", "flying disc", or "flying saucer".

You may either consider this as fiction, fact, or a mixture of fact and fiction. That decision is always up to the individual, for, to paraphrase Aristotle, we are never lied to; we must first lie to ourselves before we can accept a lie as the truth. As for myself, I HAVE NO MYSTICAL BELIEFS, ACCEPT NOTHING ON FAITH, AND ASSERT NOTHING AS THE TRUTH UNLESS I HAVE GOOD REASON TO BELIEVE IT IS TRUE. Though I never ask you to believe me on faith, evidence is sometimes scarce. I back up what I say with documentation where possible, physical evidence, an Aristotelian epistemology, accounts of my experiences and personal

knowledge, and striking facts which are too compelling to be dismissed as mere fantasy.

If some Americans have the deluded misconception that the 'Sacharovs' of this world are only in Russia, they should consider that our Sacharovs are so thoroughly buried by deceitful socio-economic oppression...carefully conceived and carried out by the Secret Government...that the world does not even know of their existences, much less that they are "virtually" imprisoned or enslaved.

The present system of nuclear power generator technology was stone-age and intentionally chosen as archaic, inefficient, and obsolete. It was already known by Nikola Tesla—even before Enrico Fermi split the atom without realizing it, and while Einstein was still a second class patent clerk in the Swiss patent office—that all the electricity mankind needs can be easily extracted from the self-replenishing atmosphere, by using a special M.H.D. (Magneto-Hydro-Dynamic) generator discovered by Tesla. It is so simple that a college freshman in physics, with an elementary knowledge of machine tools, could build and test it in his dormitory room.

A closely related, publicly available technological source of the "acceptable" variety, is in Physical Chemistry². The author laid out the scientific facts, leaving it to the creative to figure out the use. One gram of radium (approx. 1/31 oz.), placed in a lead box with an aperture directed into an air tube, criss-crossed by a magnetic field and electric field plates, will create and separate abundant positive and negative charges from air, in sufficient quantity to replace the entire Four Corners Regional power complex, indefinitely. This revelation is only a juxtaposition of Tesla's earlier discoveries of around 1904, and earlier patent of 1901. After Tesla discovered that J.P. Morgan had pretended to subsidize him in bad faith—even disguising his greed as philanthropy—in order to gain a controlling interest in all Tesla's patents, Tesla's only recourse was to withdraw his application on the patent. Nonetheless, we still have the unlabeled patent drawing, and with this knowledge, need only fill in the labels. (This patent drawing is shown in Chapter I. Tesla so feared for his life from the ominous power of the Morgan interests that he continued to praise Morgan's business ethic in public statements, saying "...I would stake my life on it...".

According to Tesla, all his inventions were initially conceived in furtherance of his "electric flying machine". The atmospheric generator is sometimes used as a power source on saucers, as confirmed by a renegade

² PHYSICAL CHEMISTRY, E. A. Moelwyn-Hughes, Pergamon Press, Oxford, 1965.

Page 224: Rutherford and Geiger found the number of alpha-particles ejected per second from 1 g of radium was 3.4×10^{10} ($k=1.26 \times 10^{-11} \text{ sec}^{-1}$, later determined by Madam Curie at 1.38×10^{-11}). Each particle carries two units of positive electricity. This will produce 34 zillion alpha - particles per second, at 4.5 Mev. The number of charges per second, yields a huge amperage which, when stepped down to normal 120 VAC, is staggering.

Page 230: 1 atom of radium expels one alpha-particle producing 1.5 billion ions, at 4.5 Mev.

Page 231: "One alpha-particle has more than sufficient kinetic energy to bring about all the ionizations which stand to its credit", and is "...quantitatively sound".

F.B.I, agent, who wrote a book about what he knew, and was forced to flee to England. The agent lacked a clear understanding of what was fully involved, but I will fill you in more completely in this book. The same method will work with a pure gas such as helium or hydrogen, in an enclosed reactor which recycles the same gas over and over. Tesla's method for extraction of electricity from air is fairly illustrated as follows (with some minor corrections to be done in respect to angles of ejection of particles and positions of plates):

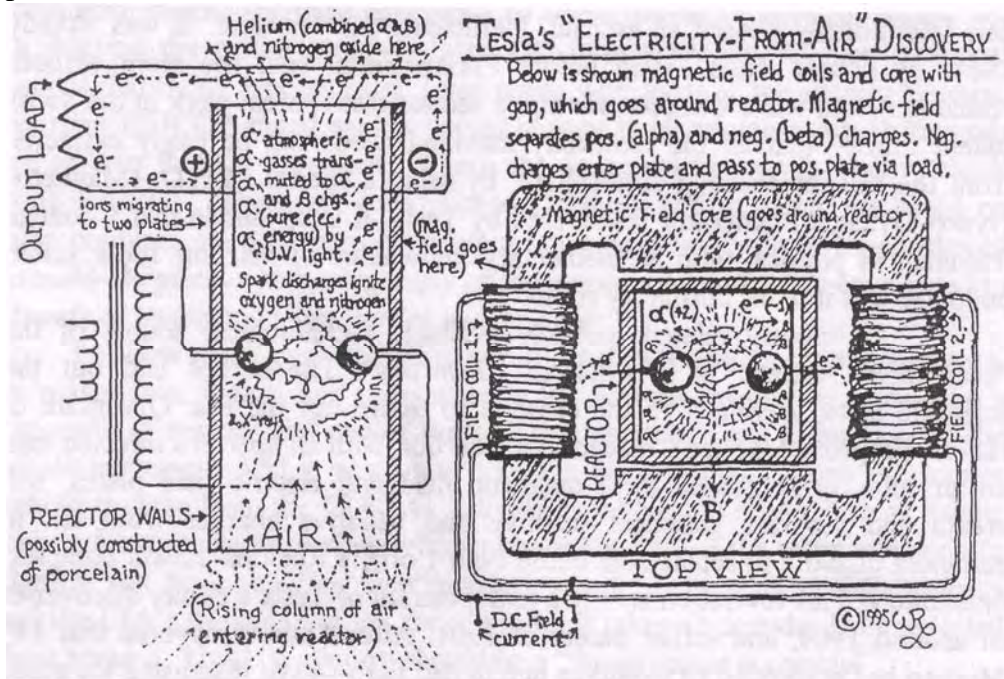

I have no doubt that, if you really read this book, it will change the way you see many things, especially the 'flying saucer phenomenon', energy, corporate power, the judiciary, and even our local cops. Just remember that, unless we all come forward and speak out, Big Brother (our government and the Trilateral Commission) will continue to spend our money to enslave us.

As for my scientific theory and flying saucer plans, I rely on the words of Leonardo Da Vinci:

"IF YOU GET IT RIGHT ON PAPER, IT WILL WORK."

This book is dedicated to my sons Angus and Matthew, to my friends, and to all the readers who showed their appreciation, encouragement and support, and to the memory of Jewel Gibson, author of Black Gold and Josh Bean and God, who, as my English teacher at Sam Houston State University in 1964, encouraged me to write.

INTRODUCTION

The first crude edition of this book was published in July, 1993, under adverse conditions and pressure which had only recently subsided. At that time, I was attempting to 'get back on my feet' after a very intense six-year period of judicial abuse, which followed on the tail of a total of 17 years of judicial abuse. This particular abuse was instigated by the CIA in 1975, through various employees, dupes, and toadies, some of whom were New Mexico lawyers, judges, law enforcement personnel, and political party officials (Democrats and Republicans), ultimately acting under orders from the CIA, beginning George Bush's advent as CIA director.

In preparing to publish in 1993, I took considerable security precautions, although I had a pre-publishing leak through a dishonest "reviewer" (who never wrote the review), in April, 1993, who was recruited by the CIA during his teen years. This gave the CIA advance notice. A copy of my original Introduction reached a CIA ("M.I.B.") around March, 1992, through a mutual "friend" who betrayed me. My first 100 copies were printed clandestinely by copy machine. I silk screened the cover, then had a local printer overprint it with black. I did the collating, binding, and trimming. The second printing, of 1,000 copies, was printed from my negatives and plates by a local printer, then collated, bound, and trimmed by me. The CIA apparently got to the printer, so I had to stay on his back all the time to get the job out much behind schedule, with only 800 poorly printed copies.

My first meager entry as a writer-publisher in 1993, saw immediate changes in UFOlogy, after no more than 50 copies were sold. After all, even before my book had appeared in local Santa Fe bookstores, the Copyright Office had certainly furnished CIA/Langley with a copy, with counterintelligence strategies soon formulated and expedited by the intelligence community. Even the first leak of 1992 (the Introduction), probably resulted in a copy appearing on a CIA desk at Langley.

As a proximate result of my 1993 publishing, the total output of OSI ("Office of Scientific Intelligence", CIA) false propaganda has at least quintupled, in terms of new movies, TV series, books, and magazine articles. There was also some specific misinformation released in video form in Germany, based on (CIA-generated) material, released through the "Hermann Goering Branch of the Knights Templars", an OSI front group, directed specifically at counteracting my book. The CIA knew as early as Dec, 1991, of my intent to produce this book, since I had announced it quite freely among legal 'colleagues' and their spies, who had harassed me for so long.

I had known for at least forty years that CIA/OSI disinformationists control the UFOlogy network, which they themselves created, involving all mass media, especially TV and publishing. As I anticipated, they were among the first people to contact me, their general plan being to give me the 'kiss of death', consisting of quickly arranging to distribute my book—a 'holding action' intended to induce my detrimental reliance and to create a time delay—as they picked my mind, and counter-published "monkey-see, monkey-do, look-alike-type" books, videos, and magazines intended to protract the same old mis-and-disinformation, while attempting to "steal my thunder", by pretending to say something superficially similar in their books—which, unlike my *samisdat*, would be

massively distributed—to counteract it before the general public could be exposed to my long-suppressed message,

Their main strategy however, was to increase the sheer volume of material in the bookstores, to make my single book a proverbial 'needle in the haystack'. Basically, they BURY you in their B.S. At the same time, they loaded my mailbox with a barrage of their propaganda, thinking that they might 'contaminate' my stuff with their phony 'alien' stuff and other incredulous garbage. I knew long before looking at their material—and can with confidence project this to include their future material—that they now have, and will in the future have, nothing new to say, and are only repeating the same Old Tired Big Lies in a slightly more "sensationalized" and cosmetically disguised form, to 'fresh' audiences each year. In addition, they have regenerated a whole new batch of the same old fabrications in the areas I addressed, such as the facts surrounding the end of WW II, in respect to the "secret" amnesty and partnership agreement between the U.S. and Germany, and what I call "The Phony Fall of the Third Reich". They have also created a profusion of names for German flying saucers and flying saucer projects, most of which never existed, were called by other names, or were known by disguised code letters, such as "p2" and "KT-p2" (the projects I unearthed) were known by. I pretended to rely on these first contacts, using them to whatever limited extent possible to distribute and popularize my book, while pursuing several other avenues of approach to the public. Many distributors are CIA fronts, since prompt dissemination of their propaganda throughout the UFOlogy network is indispensable to their jobs in the intelligence disinformation network. Those distributors who are not witting CIA fronts, or complete dupes, have become so economically invaginated with the CIA-created mythology, that they could not afford to immediately free themselves, even if they wanted to. Economic dependency is a powerful motivating factor.

One of the propaganda thrusts spread the erroneous idea that the "Nazis" invented the flying saucer. With apologies to the ghost of general George Patton, let me suggest that this is tantamount to saying that such a thing as the A-bomb or the airplane is a "Democratic" or "Republican" invention! Firstly, a "Nazi" or "Communist", per se, never invented anything, since only individuals do that, and have usually been looted by various statist cretins throughout history. Secondly, the "totalitarian mind" is by its nature one of a collectivist looter and enslaver, not of a creator or producer. And finally, Nikola Tesla's invention of the "electric flying machine" which was later to be called the "flying saucer" or "UFO", is documentable back to the early part of this century, while his conception of it goes back to the 1870's, during his student days at the Technische Hochschule at Graz, Austria. The idea of Nazi flying saucers is as old as the hills, beginning with the 1944 "Foo-Fighter" publicity, yet even this has remained somewhat suppressed because, though incomplete or incorrect as propagated, is a version which is revealing of certain scientific facts (the corona discharges) and close enough to the truth to point a skilled independent investigator in the right direction, and eventually toward the truth, provided he is armored with sufficient scepticism to traverse the precarious minefields (mindfields) of disinformation which have been laid on all sides. I again emphasize that all the ascertainable secret German documents and important developments came into the hands of the OSS/CIA at the end of WW II, not only

ALIENS2

because of such thoroughly exercised searches, but also by the anti-virtue of the special "deal"—ala Operation Paperclip and Reinhard Gehlen's Amt VI¹— between Germany and America. There are no documents from the Nazi sources or from our government or any cooperating government, which have not been either destroyed or permanently classified, or first been given the disinformation "treatment" by the CIA, before being "declassified", released or otherwise covertly disseminated through whatever outlets anyone may claim. This same rule applies to the statements of all active, former, or retired military or government personnel who were subject to a security order, for a period of at least 20 years from the date of said order or agreement, and all agreements of a higher order, relating to knowledge of flying saucers, even apply a lifetime statute of limitation. Incidentally, I possess the only known true 'leak' from the original Nazi flying saucer source, via a security lapse of Sandia Base personnel in Albuquerque, New Mexico. The FBI's statement on this matter was that I could not be prosecuted for possession or disclosure because I had "...obtained all my information through innocent means." In addition, I have not been subject to a national security agreement since 1977, 20 years after I signed an agreement while in AF Intelligence in my 18th year. Since I was never given direct access to flying saucer secrets anyway, the information I independently collected and developed on my own was never covered.

The main person attempting to spread the idea of a "German origin" for the flying saucer, is an unabashed 'Naziphile' named Ernst Zundel, who owns Samisdat Publishers Ltd., Toronto, Ontario, Canada. He began his publishings at least as early as 1976, and like me, underwent intense judicial harassment, but was misled to believe the harassment was because he is a German "holocaust revisionist" or 'denier', while the apparent reason is because his flying saucer material is "too close" to the truth. The more Zundel was harassed, the more adamant became his Naziphilia. Meanwhile, some of his best saucer books went out of print, just as his harassers desired. Zundel has remained completely unaware that it was really his saucer material which attracted the animosity of the Canadian national security establishment, pursuant to the secret orders under which he was judicially harassed, similar to how I was judicially harassed in New Mexico, under the ostensible guise of "property dealings", during the same approximate period of time.

Though novel in some respects, Zundel's idea of how German saucers worked was incorrect if not completely lacking, being unfortunately subject to prior Nazi/CIA disinformation via Paperclip, and a vague idea of jets, rockets, or some mysterious, esoteric "anti-gravity" system of Felix Schauburger, involving a "water vortex". The Canadians were most likely worried that Zundel might turn up a German-to-Canadian technology transfer dating to 1945 or soon thereafter. In 1953 I made my first close-up daylight sighting.

In 1961 I had discovered the 1941 Nazi testing of the neutron bomb on the Libyan desert. In 1963 I discovered the exact scientific basis for saucer propulsion, and in 1966 found out about the "stalemate" of 1945, involving 24 German "Electro-U-boats", towing specially designed, smaller subs, carrying (what I believe may have been V-6) rockets with celestial guidance systems and armed with neutron bomb warheads, fueled by red mercury (a mercury-antimony oxide which

¹Christopher Simpson, BLOWBACK (Weidenfeld & Nicolson, New York, 1988).

originated with alchemists of old). In 1996, a documentation of these small missile-carrying subs, developed under the "Laffrenz Project"¹ was provided to me by Henry Stevens of the German Research Project, Gorman, California. The smaller, rocket-carrying subs could be tilted to the correct firing trajectory when desired. Like later American I.C.B.Ms, such as the Polaris A-1 missiles carried by our Lafayette class nuclear powered submarines, the missiles could be fired from underwater. I also learned in 1974 that Wernher von Braun had worked in New Mexico in the late 1930s, something which was common knowledge among local rocket pioneers whose work dated from that period, such as the late Peter van Dresser of Santa Fe and El Rito.

I had no source for the complete saucer electrical theories and mathematical formulae, until 1979, a year in which I made great headway. In that year, I acquired knowledge of a 1937 pre-WW II Illuminati "p2" project at Los Alamos, run by von Braun, and acquired the only known extant piece of physical evidence from a WW II 1943-vintage German flying saucer, based on the Tesla discoveries first developed in New Mexico and taken to Germany, before being returned to New Mexico around 1945. This evidence is a celestial guidance slave compass from the "KT-p2" project, in which von Braun included the original New Mexico 1937 "p2" project name, after he had removed it from Los Alamos and transported it to Germany, in 1938, with the apparent good graces of our FBI. The device was on one of the German saucers brought to post-war Sandia Base under Operation Paperclip in 1945, soon followed by a 15,000-person German scientific contingency's exodus to New Mexico². The guidance system was an invention of Nikola Tesla, developed and tested on a 200-mile round trip radio controlled aircraft flight test in conjunction with the Sperry Gyroscope Company, in 1917³. I eventually located the source and substance of the scientific data and formulas for the saucer, rediscovered the electromagnetic method for its application, and documented the previously suppressed and intentionally confused historical background concerning the work of Nikola Tesla. In 1997, I authored OCCULT ETHER PHYSICS: Tesla's Hidden Space Propulsion System and the Conspiracy to Conceal It (ISBN 0-9637467-2-3), which I revised in 1998 (ISBN 0-9637467-6-6). It is a documentation of the 19th century scientific research leading up to Tesla's great discovery, which at its earliest, appeared to be in 1891.

Zundel had approached the saucer question with the characteristic tunnel vision of one intent on cleansing away and assuaging German guilt for the crimes of Nazi-era Germany. This is as silly as an old Stalin-worshiper trying to say that Stalin didn't kill off millions of his own people, even including ten million members of his own Communist party. When will people realize that the purpose of Illuminati-created wars is to kill off as many "excess" Germans, Jews, Russians, Americans, British, French, Gypsies, and other peoples as possible? All Hail, Kali Ma! And when are people going to realize that, since the 1770's, the ultimate blame does not properly rest on any

¹Lusar, Rudolf, 1960, German Secret Weapons of the Second World War, Neville Spearman, London; Stevens, Henry, Rumored German Wonder Weapons, Report Number Three, Fantastic German Submarines, German Research Project, Gorman, Ca., 1996.

²Discussion between the author and Maj. Helen Nash, Wehrmacht Intelligence, FRD, between 1966-70, Univ. of Tex., Austin.

³John J. O'Neill, Prodigal Genius, The Life of Nikola Tesla (David McKay Co., Inc., New York, 1944).

ALIENS4

single national group, per se, but with the Illuminati/CFR, rather than with all those who became the cannon fodder/suckers in this massive international conspiracy of "population control", munitions-profiteering and power-consolidation, led by a cabal of central world bankers, especially the banking houses which arose out of the late 18th century German kingdom and the House of Hesse-Kassel. It is no accident that Adolf and Eva Hitler lived out their last days in Kassel. "Oh, really!", you exclaim. Read on.

Despite Zundel's controversial view, he was almost correct about Hitler's planned last-ditch stand against America, using flying saucers and other 'wonder weapons', along with several other 'Wunderwaffen' which were not mentioned as such in Zundel's material, but which I identified for the first time, as the basis not only for one of Hitler's brilliant alternate plans—according to the judgment of the best Russian military analysts who later studied it—but for another even more brilliant plan for which the first plan-evidence of which was conveniently left for the Russians to find in the Berlin Fuehrerbunker—was a mere cover, and which was actually consummated by the coercion of a secret amnesty and partnership agreement between the U.S. and Germany, buttressed by the exodus, under Operation Paperclip, of Nazi saucer R&D, over 400 top scientists, and over 15,000 scientific and technical "slaves", to the U.S. government and the IllumiNazi corporations and banking interests. This plan is so embarrassing that they dare not fully declassify it even today. Though this revelation may startle some of you, its truth is gradually falling, piece by piece into place, from evidence continually surfacing all over the world, especially since the collapse of the Soviet State.

Some people have mistakenly attempted to trace the destination of the Nazi "technology transfer" to Antarctica or South America, and I'm sure the CIA fuels this false scenario which they created. Some of this technology and people involved may initially have gone to South America or elsewhere prior to the finalization of this agreement, until the treacherous combination of the German Amt VI ("Dept. 6") SS RSHA (the Nazi organ upon which the CIA was based), the new CIA created on the Nazi model, and British, Canadian and Australian intelligence, and even Russian intelligence, found and took care of them, where any critical part of the "Big Secret", or any key scientist was" involved. The simple truth is that the flying saucer technology and personnel came to the U.S. of A., lock, stock and barrel, right where Hitler and the rest of his gang agreed to, in order to buy their asses a new lease on life.

My original edition of this book is the most important publication of all time on flying saucers. True to my anticipations, the inevitable CIA look-alike books and other counter-publishings have not plagiarized my original theories, since their objective is not to claim my theories or to advertise them, but rather to "steal my thunder", to overshadow, cloud and suppress my actual findings and distribution of my book, and to obliterate what I have to say, with a voluminous mass of bullshit, spread primarily through the CIA's "UFOlogy network". They have not attempted to discredit, mention, or even to discuss my theories, since this would attract the public's attention, invite meaningful dialogue, and draw in true scientific scrutiny, which I welcome. They prefer to pretend my book does not exist, while using the 'placebo' effect to pacify the public's continual thirst for answers on impertinent questions, while confusing or misinforming them on the American and Nazi saucer developments, through CIA-doctored pseudo-leaks and other blind allies. In addition, they have spewed out a virtual mountain of fresh bullshit, since August, 1993.

ALIENS5

Zundel was suppressed until my book was published. Then the CIA and Canadian intelligence were apparently forced to rethink their strategy in respect to Zundel's work, 'sanitizing' it of Zundel's involvement and his anti-Semitism, through their own writers, in order to re-propagate his material as a convenient false history of the initial origin of the saucer, as well as the phony, CIA-created science involved, promoting a scheme based on either "esoteric" or "conventional" propulsion systems, but not true Tesla "ether physics". The CIA now uses Zundel's saucer material, since there is nothing harmful in it, because the information available to him had already been carefully screened by them in 1945, for all potentially valuable information, then altered before being declassified and made available to Zundel and other interested parties. All important information which could not be falsified or misinterpreted, remained classified. Besides, the Germans themselves were quite capable during the war of creating information "scrambles", and running 'aerodynamic' saucer projects, just to conceal the 'real' one, most likely at Zeppelinheim, south of Frankfurt, or at the Blohm & Voss works in Hamburg, confirmed by a knowledgeable spy friend assigned to the area of Hamburg during the war. Reinhard Gehlen's Amt VI SS RSHA was quite capable of such mis-and-dis-information, in fact invented the CIA's version and implemented it for them. After all, hadn't the O.S.S. hired Reinhard Gehlen's Nazi intelligence network under Operation Paperclip, forming the nucleus of the new CIA?

From the moment that the electro-propulsive saucer's full potential became evident in the early 1930s, forward to the present, rocket projects have been a cover for the "real thing", and ironically, this sham was first actualized in 1937, at Los Alamos, New Mexico, based on stolen Tesla technology, under the tutelage of Wernher von Braun. Hitler had appointed the Prussian Illuminist as "Herr Doktor Professor of Research" and project leader to run his Vergeltungswaffen ("revenge weapon") center at Peenemunde, before his collaboration with the American rocket pioneer, Dr. Robert Goddard, at his laboratory in Mescalero, New Mexico, and rocket test site at Eden Valley, New Mexico.¹ Afterward, von Braun would never allow the high priority ("p2", "KT-p2") 'space travel' project to be too far away from his watchful eye. While collaborating with Goddard at Mescalero, von Braun ran the Illuminati flying saucer project at Los Alamos called "p2", between 1936 and 1938!² He was given a leave of absence by Hitler for this espionage, and was brought to America by the Smithsonian Institution, the Guggenheim Foundation, and the American Rocket Society, who financed his work and paid for his trip!

A lot of look-alike material presently attempts to mislead the public with the idea that flying saucers were invented by "Germans", were exclusively rocket, jet, or turbine-powered, were based on aerodynamic ("boundary layer") principles rather than electro-propulsion, some vague, (CIA-pseudo-leaked) esoteric 'mercury gyro' "vimana" powerplant, the "water-mystery-power" of Viktor Schauberger's "implosion turbine"—to blow air through what was presumably no more than a glorified, frying air conditioning vent—and that the saucers we see today are based on these. There were several types of German hovering craft which used technology other than electro-propulsion, and even some which combined conventional rocket, jet, or aerodynamic lift with electro-propulsion. Despite all this, what we really call the full-blown "flying saucer", per se, in all

¹The author's discussions with rocket pioneer and scientist, Peter van Dresser, 1973-1979.

²The author's discussion with an unnamed employee of the 1937 project in May, 1979.

its glory, is exclusively electro-propulsive, being originally based on technology discovered and developed by Nikola Tesla, before being stolen away to Nazi Germany by Wernher von Braun, in 1938. Despite the thoroughness of the FBI, O.S.S./CIA and the Gestapo, enough evidence remains to document the fact that Tesla's original saucer developments were earlier than the first successful liquid-fueled rocket shots of Goddard, Oberth, or von Braun, and the information I unearthed here in New Mexico, documents the acquisition by 1937, by German interests, of Tesla's discovery, indicating the long-standing fallacy of the rocket projects, which were gleefully paraded before us all those years by von Braun and his American Peenemunde clone, NASA. None of the material from Zundel or from other German sources even mentions the "KT-p2 Projekt" (muchless "p2") or von Braun as its real head, or mentions anything about the technology I alone uncovered. While some vague disinformation regards "Nazi experiments with electrical discharges" (said to relate only to "electronic jamming devices"), the allegations of "electrogravitics" are based on vague, esoteric and even 'ancient' pseudo-sources (which in fact are pure mythology), and the information goes no further. Other information from American sources is inconclusive and tainted by the presumption of misinformation as well, due to its prior control by the CIA.

For example, "How...", you may ask, "...could the CIA (or its affiliates) plant ancient 'Vimana' material in ancient Hindu or Sanskrit manuscripts?" It should not amaze you to know that many of the 'interpreters' of such works were often East Indians with Oxford or Cambridge degrees, who worked with British intelligence and MI-5, and the OSS in the WWII Asian Theater, and that intelligence agencies hire many such scholars and finance their work. Their interpretations are often a matter of...interpretation. What is meant in Hindu mythology, as an analogy to the Arabian 'flying carpet', suddenly becomes a "space ship". While I may know for a fact that there was advanced machine technology akin to ours today, in 1450 B.C., the Vimana stuff isn't it. Playing around with mercury (the so-called "mercury gyro") isn't easy, and many of the theories I've heard are just plum dumb. Besides, if you have any concrete idea of aeronautics, and you've ever really looked at the "Vimaana" stuff, you will see for sure that it is obviously dumb.

The true electro-propulsive principle of the Tesla-based American-German saucers cannot be found by ordinary research, because the CIA has already covered all the bases. There is a publisher who would have stolen my thunder on this issue, but was unable to discover another source, so was stuck with the options of either acknowledging and citing my prior publishing, research, and detective work, or of plagiarizing me, so he begrudgingly "...killed me with faint praise". I tend to think his reluctance reflected either CIA pressure, or his fear of the strong possibility that I will subsequently be proved correct.

Another jealous author who agonized over my discoveries, who claims to be a physicist, even made the ridiculous claim that he "discovered" that saucers are powered by gyroscopes. Gyros create only feeble gravitational 'anomalies' ("weight loss" but not "anti-gravity"). He appears to have gotten this idea from a combination of the Vimana' literature and my book, since I was the first writer to introduce the fact that the Kreisel Teller processed, which was the only solid tie between flying saucers and 'gyroscopic' action, other than vague references in recent CIA/OSI pseudo-leaks through German and Austrian sources, to a Flugkreisel ("Flying-Gyro"), in misinformation designed to tie into the pseudo-"discovery". Later CIA-produced 'German' documents contain the word "Kreisel" ("gyrating" or "gyroscopic") in misrepresented contexts. This man had no prior source other than my book. When I met him in the summer of 1994, he immediately asked me about a matter in my book, right off the top of his head, but never

mentioned me or my book in his bibliography. I suppose that since I discussed and rejected the gyro idea, he was free to claim it, but the idea wasn't mine in the first place. Since he had obviously never seen a saucer up close, if at all, it was probably my mention of the precessive effect which reinforced "gyroscopic antigravity" in his mind. Aside from my pointing out the saucer's precession, the theory of gyroscopic antigravity is as old as the hills, and no one has ever been able to lift a ship off the ground with it, because the magnetic field of the earth is far too weak. This pseudo-scientific theory has always been encouraged by the CIA, since it is wrong, and serves no better purpose than to buttress and further embed such false explanations into the UFOlogy field, and to damage the scientific credibilities of all those foolish enough to espouse or to believe it.

The alternatives presented are: (a) the "air-blower" ("boundary layer") aerodynamic propulsion systems based on the theories of Ludwig Prandtl and the unverified work of Viktor Schauberger; or (b) an ancient, obscure 'vimana' propulsion system (purportedly a "mercury vortex" drive) misinterpreted from East Indian Sanskrit religious texts such as the Bhagivad Gita; or (c) an unknown propulsion system based on "shared alien technology" which is "too complex for our comprehension"; or (d) centrifugal force gadgets which sling weights around in attempt to increase the centrifugal force in one direction and decrease it in the opposite direction (failing to take into account that the 'increase' in centrifugal force in one direction causes the device to behave as if the center of rotation were in the center of angular momentum, so that the 'gain' on one side is canceled by a loss on the other); and finally, (e) the purely electro-propulsive ether-based system which can be documented in the work of Nikola Tesla as far back as the 1870s.

As you should see, the last alternative is the only feasible one, and I have documented its discovery in Occult Ether Physics. There are several other minor systems originating with various tinkerers which just won't make the grade, some of which involve tortured mathematics and pseudo-science of the ley line, geomancy, and Stonehenge variety, etc., or some mysterious stuff called "Schumann resonance" (which was declassified by the CIA when they disseminated the documents referring to it), and finally the work of the Englishman, Searls, which is only rumored to get off the ground, but obviously lacks a control system. Some experimenters may have inadvertently stumbled across something which causes weight loss, or a feeble thrust, but without understanding the simple and correct ether concepts and physics, are unable to succeed, mostly because they are looking for something too complex, if they have not in fact been supported in their futile research by the CIA. Altogether, the alternatives other than the Tesla proposition, too conspicuously place saucer propulsion in the area of the unknown, the unobtainable, the wacko, or depict it as the obscure and indeterminate work of mystical, pseudo-scientific cranks such as Viktor Schauberger or Bruce Cathie.

When you see a real saucer performing at its high capabilities up close, you know it is not powered by any of these feeble contrivances, but requires the great force and magnitude which can only be scientifically attributed to the gravitational-to-electromagnetic conversion constant, which is $10^{40} \times fg$. The opportunity for a civilian to see a flying saucer up close is much rarer today than it was in 1953, on the West Texas desert to the south of Alamogordo, New Mexico, where the German prototypes were brought, tested and developed after the war.

Since none of the writers I know of producing recent works, have ever seen a flying saucer as I did in 1953, or possess the scientific perspicacity required to interpret what they saw, I can only conclude that their information is Johnny-come-lately "researcher", second-hand conjecture and speculation, abject CIA-duped falsity, or outright CIA misinformation, since almost anyone of

scientific mind, who ever actually saw a flying saucer in the glory of its full potential, would immediately laugh at such phony, CIA pseudo-science, Nazi ass-kissing books, new age charlatanism, illicit money-grubbing plagiarism, and grand-standing sensationalism.

As my acquaintance, former Air Force Colonel, Phil Shaw, of Austin, Texas said in 1967¹, "There haven't been any leaks". Shaw was the former director of two of the most important regional offices of Air Force Intelligence's Operation Blue Book—Reno, Nevada, and Reykjavik, Iceland—before studying jewelry making at the University of Texas. Both before and since then, there were some leaks, and I'm the one who had his bucket set to catch them. I made no bones about it with Shaw, openly accusing him, in the presence of professors and other students, of bending to his CIA orders, in our life drawing classes at the University of Texas Department of Fine Arts. I even embarrassed him a little bit when I showed other students that the lock on his locker in the hall was CIA issue! Shaw made a weakly valiant effort to discredit me, and I thought it no accident that Iceland was a strongly suspected site for wartime German saucer bases, while Reno, Nevada is very definitely 'saucer country'. Shaw knew I was right, but could never admit it.

No gyros, rockets, jets or 'conventionally powered saucers could ever produce the results I saw in 1953, and neither could "mercury gyros", "air suction" or "boundary layer" methods. I knew that a very powerful electrical force, which could be instantly altered and changed in direction, was involved, and this book is the first and only known book to reveal a viable scientific basis for this very real force and the simple method by which it is implemented and controlled. No other researcher in this field has provided any means by which such great force, directional control, or maneuverability could be effected, mainly because they are ALL either CIA employees, whose job it is to hide it, or "second-handers"... "writers" and "researchers"... who can only follow up on CIA pseudo-leaks, snooping around for things which are just not there, or which were conveniently placed there by the "Puzzle Palace", so that these researchers "...found the pieces, and put them all together" (just as the Puzzle Palace planned), thinking they had really 'discovered' something.

I am not only a writer and researcher, but an inventor, analytical and original thinker, experimenter, sceptic, science detective, debunker, and a self-taught theoretical "ether physicist" of the first order. Of course CIA propagandists of the CSICOP ilk like Philip Klass, will only scoff at the inclusion of "debunker" and "ether physicist" in the same breath. Klass and a few others represent the CIA's invasion of the "secular humanist" field, to take it over and use it as another OSI base of operation to attack flying saucer or alternative science researchers, or writers who may threaten to uncover what I call the true, "occult" science of ether physics. This is a brilliant and effective tactic, except for the fact that the "officially accepted" Big Lie physics of today is a prima facie case of flakiness, based on the phony "elastic space and time" concepts taken by Einstein from the Lorentz Transformation, giving birth to Relativity and the "Big-Bang" cosmography, false theories for the public having their roots in the Machiavellian manipulations of Rosicrucianism and the Hermetic Mystery Traditions. In so doing, the CIA has managed to suck the humanist/sceptic element more firmly into supporting a flaky and false Relativism when, as true sceptics, they should be looking into the concealed alternatives. Why have they accepted on faith the now 'traditional' relativism/big-bang physics, which is interconnected to the

¹Discussion of the author with Col. Phil Shaw (USAF Intelligence., Ret), U.T. Dept. of Art, Austin, Texas, 1967-70.

mixed premise Kaballah-Bible-Talmud-Koran-whopping, paranormal-pushing "traditionalism" (which in fact has also been created or supported by the Secret Government of which Klass is a representative). Are there really many intelligent people who have accepted on faith, the assertion by Klass and his psychophants, that all of the millions of people who have seen "UFOs", have only misinterpreted "natural phenomena"? How many have been led astray by these leading CIA 'spotlights', Philip Klass and the Smithsonian Institution? Klass's false and in fact mystical assumption that all flying saucer "believers" assume that saucers are of extraterrestrial origin, and simultaneously believe in ESP, ghosts, and other irrational paranormalism, is itself a "paranormal claim" being made by Klass. Those who live in glass ("Klass") houses shouldn't throw rocks. I promise as a true sceptic not to make even one 'paranormal' assertion or claim!

The fatally tragic flaw of most "alternative" scientists, is that, in attempting to understand "ether physics", they have irrationally tried to reconcile immiscible Relativism—created by the Hermeticists to conceal ether physics—with ether physics, which is based on the "Fixed Universe" theory, which is not nearly so static as the "Big Bang" theory and Relativism True sceptics would be critical of the mystical physics being enforced upon us by the establishment media.

By comparing the gist of my book with what the OSI has conspicuously omitted or artfully confused, it is clear what they seek to hide. They have hauled out all the old time-worn OSI mis-and-disinformation, and erroneous CIA-tampered Nazi stuff, all altered before being made available to anyone. The documents of the Nazis were collected in the days when they shot first and asked questions later. A review of existing theories shows that, until this 1993 book, the truth was concealed. Isn't that rather odd? My over 40 years prior knowledge made me feel very alone, and I have never ceased to be amazed at the garbage the public has swallowed all along the way.

It should be obvious to intelligent readers as to why my simple, rational, scientifically verifiable explanation—conspicuously absent from all prior sources—has been omitted. I had known since 1953 that the propulsion system was electrical, a fact systematically omitted from the milieu of ideas and information available in prior sources. There are only three possibilities for saucer propulsion, which are (1) electricity, (2) electricity, and (3) electricity. That is because ether propulsion can only be electrically created

The thing which makes the 'electro-propulsive' flying saucer—as well as universal gravity—possible, are some odd flukes of nature, involving the natural interplay between fundamental positive and negative electrical charges in elementary matter, the existence of a universal ether (which I call "Omni Matter"), the permeation of space by omnidirectionally interpenetrating Zero Point Radiation ("ZPR"), and the natural electromagnetic field and enormous electrostatic forces emanating from the earth, which affect the ether through which it moves. The proof of the pudding is in the eating, and intelligent and knowledgeable witnesses who have seen a saucer in action up close, know it is real, and should see that it works on electrical principals. The things which makes these truths now available to you, are the fundamental intelligent human thought processes which are essential to your survival as a creative and independent, thinking person, rather than to give your mind over to the sway of a raving and hysterical Naziphile or other mystic who is peddling irrationality and endless fantasy for the Pentagon, in hopes that he can obtain money, by supplying phony answers which always requires more scientific knowledge and understanding than anyone possesses, so the truth remains concealed just as the Pentagon planned.

The so-called "UFology field" is full of CIA "organ grinders" with their dancing monkies or ventriloquist dummies, who only repeat what their controllers say. Most of the "big guns" are

professional CIA liars. In over 47 years, they have failed to bring forward a significantly new issue, and with the overflowing help of the CIA's abundant publicity machinery, have been singing the same Old Tired Tunes, based on a set of scenarios pre-generated by CIA contract writers in 1947, as one of the first projects of the newly created agency, under the so-called "National Security Act", which was no more than an executive edict which Congress was never even provided the opportunity to approve or disapprove. With all the typical themes already 'set', writers who work for the CIA have a rather hackneyed job of trying to come up with new kinks on the same old themes, always avoiding the one true theme which has been so conspicuously omitted, which to me is much more exciting than all their shabby, shopworn "alien" fantasies.

The CIA-UFOlogists have a very tell-tale fatal flaw, similar to the Illuminati, their bosses. This flaw, which will be the cause of their eventual downfall, is a lack of creativity, which gives them a need to incestuously breed, copy and repeat contrite old lies in order to steal the truth. This fatal flaw is best illustrated by an ancient analogical story about a monkey which was trapped and enslaved by its own self-negating greed, as follows:

A young man was attempting with no success, to capture a monkey in a jungle. Along came a wise old man, who kindly consoled the discouraged young man. and said, "In order to trap a monkey, you must first understand the basic nature of a monkey, and "think like a monkey". I will show you how it is done." Whereupon the old man took a glass jug, filled it half way up with nuts, and tied it firmly to a tree. The young man asked, "How do you expect to trap a monkey with that?" The old man, with a smiling, wry twist of his wrinkled old mouth, said, "Just wait, and you will see." The two men hid in nearby brush, and remained quiet for an hour or so, when finally a monkey descended toward the jug from the dense foliage above. Seeing the nuts in the jug, the monkey extended his skinny hand into the jug, grabbed a large handful of nuts, and attempted to pull them out, except the mouth of the jug was too small to allow the passage of the monkey's hand full of nuts. Nonetheless, the monkey tightly gripped the nuts, refusing to release even a single nut. He stupidly continued to tug at the nuts to no avail. The old man came from his hiding place with a rope, and simply walked up and placed it around the alarmed monkey's neck. The monkey allowed himself to be captured, rather than to release his grip on the nuts in the jug.

To the stupid monkey, stealing nuts was more important than his personal freedom, which he never missed, until he didn 't have it anymore. Then he sadly became a mere toy for the amusement of others, who kept him at the end of a leash when not in his cage, for the rest of his life. The monkey was sold to an old CIA organ grinder, and learned to dance at the end of his leash, to a collection of redundant Old Tired Tunes, monotonously ground out on the old man's whining organ, as the monkey begged for money on the streets of Washington, D.C. Just across the street from the Pentagon.

VERISIMILITUDE

The "nuts" are hidden truths. The "monkeys" are "UFOlogists", on the CIA payroll, and the "Old Tired Tunes" are the same old CIA "alien" and other disinformation scenarios. The problem with the hidden truths, is that they are poisonous to the CIA, and therefore incompatible with the CIA Big Lies, which they will 'contaminate', compromise, and destroy.

All compromise leads to corruption, an attempted mixture of immiscible or incompatible things. Most UFOlogists are indecisive, mediocre, unoriginal, muddled thinkers without spines, the great majority of whom are "second-handers"—literary piranhas who feed in a frenzy off the ideas of others—and mix stolen ideas together until they are as clear as mud. They often make exaggerated claims to be 'first' at something, in their hasty and greedy attempts to steal the thunder of those who really were the first at some things. They are required to avoid the 'poisonous' ideas (which they seek to obliterate). They usually conceal their thefts, by combining many dissimilar things as a smokescreen—selectively adding a little more here and there—to conceal the fact that their original core of ideas are stolen. In their greed and haste, they miss the point entirely, which is the CIA's intent, since "misinformational reverse-engineering" is really what the CIA wants UFOlogists to do, to create confusion where before there might have been clarity.

The CIA-inspired books are obvious attempts to confuse and use shallow minds, to avoid the rational and clear thinking required to understand the subject at hand. Brilliant intuitions are just not the province of hackneyed CIA dupe writers. It must be very frustrating to be one of them, knowing that whatever acclaim they might be 'allowed' to achieve by their bosses, is meaningless and hollow, based on "discoveries" pre-conceived by committees of CIA Ph.D.s.

There is a lot of CIA garbage out there, often purporting to be "great revelations" about such subjects as "Nikola Tesla's work", "anti-gravity", and "free energy". I have never seen so many books, pages, and words so totally devoid of originality, perceptiveness, enlightened consciousness, or any significantly real knowledge about the subjects purportedly covered. Some of these people are literary vacuum cleaners—"brain suckers"—of the ideas of others. They lack the special knowledge to comprehend the material they are purporting to deal with, so their books are little more than bundles of dissimilar ideas packed together without coordinated or integrated editorial comment or design, propagating collected-from-others, self-neutralizing concepts, often claiming that "the author discovered" or "the book reveals" this or that, or 'exposed' something or other, which it never did anything of the sort. Not a single novel revelation or concept is placed in them by the bureaucratic committees which write them in haste. The most this trashy stuff can do for the Illuminati oil, energy, banking and transportation cartels, is to buy a little time. It makes me wonder, for example, how much time can be bought for say, \$10 million in false propaganda costs (which we ultimately pay for)?

I don't believe that the public can continue to buy into these hoaxes forever, because there are many intelligent, technologically gifted and discerning people in our society, who have remained in the background, because the CIA garbage has never significantly attracted their interest. These people have held their opinions and conclusions in abeyance, until a more reasonable explanation comes forth, such as that already provided in this book.

One of the my basic concepts is how great ideas have been lost throughout history, by having fallen into the hands of evil and cunning, fraudulent sociopaths, barbarians, destructive religious fanatics, liars, charlatans, and hucksters, or in this case, coercive monopolists. One of the greatest examples of this in ancient history, was the destruction and looting of the great Library of Alexandria, now in Turkey. Had the keepers of the library not collected so much of the ancient world's greatest knowledge in one place, it could not have been destroyed there and lost to history and humanity, in one catastrophic event. Given the extent to which documentation shows that ancient conspiracies have been connected to the concealment of illuminating knowledge, just as in our own time, it would not surprise me to learn that the fall of the Library at Alexandria was

engineered by an ancient Mystery School cult, with the fall of the city to the Turks being either preceded by the documents being carried away to...the Vatican Library...or spirited away to the Alhambra. Perhaps that is why the medieval Moors in Spain maintained much of the lost knowledge, while the Dark Ages descended on Europe. The similar accumulation of such knowledge in the secret vaults of the national security establishments of the world today, suggests the possibility of a repeat of ancient history, which could set the human race back yet another 1500 years. Though there are some who may relish this idea, a millennium of ignorance or the black plague do not sound so enticing to me.

This book is dedicated to the idea that individuals in free society should take control of their destinies, beginning with the apprehension and use of flying saucer technology right now, in order to set the human race on its natural path, onwards and upwards to a higher level, free of Illuminati exploitation. The Illuminati cannot have it both ways. They cannot steal from us and continue to hoard secret technology to use on us, without our eventual discovery of the sham, and the use of lies to suppress advanced knowledge. Ultimately, they cannot steal my thunder without revealing their dishonesty and motives. At the risk of being a deluded optimist, I still believe that We the People will eventually prevail, that you will know the truth, and that we will all eventually be free. Until that time finally comes, "I told you so".



Graphic by Angus Lyne

THE ACHILLES HEEL OF THE ILLUMINATI:
"Ether Physics" and Flying Saucer Propulsion

Since so many of the Trilateral/IllumiNazi/Coercivists' ill-gotten gains are in the motor fuel and transportation fields (ships, autos, trucks, trains and planes), I believe the truth concerning flying saucer technology, and use of it by the public, is their "Achille's Heel". Why else would they have labored so diligently for over fifty years keeping such technology secret, ostensibly under the guise of "national security", except to perpetuate their coercive socio-economic, technological and political monopoly?

This conspiracy is illicitly, thoroughly, and often brilliantly enforced and propagated by the Office of Scientific Intelligence ("OSI", CIA), coordinated secret political police, the military, the local police, and the judiciary. The OSI takes a more "active" covert role than other government counterparts, in the dissemination of false propaganda, the creation and orchestration of "UFOlogy" and other front groups, and control of 'key' individuals through subterfuge.

The most obvious, stupid flaw in the propaganda, disseminated under cover of such T.V. series as The X-Files and Sightings, is the fact that, if all the paranormal stuff pushed by such programs were really so damned secret, why would prime-time T.V. programs try so hard to convince you it is true, or even tell you about it? Since when does government disclose, or allow the disclosure of, its biggest secrets, on prime-time, big-network T.V., which is all owned and controlled by the Illuminati, and policed by the OSI/CIA? In respect to "military secrets", what you see and think, is what they want you to see and think, they think. Unfortunately, everything on national media is under FCC control and subject to "national security" screening, to insure that "classified" information is not disclosed. Each transmitter has a specially trained N.S.A. employee, in a remote room which contains a listening post and a switch to the transmitter. The job is called "transmitter watch". The employee's job is to listen, with orders to turn the transmitter off whenever anything 'prohibited' by N.S.A. guidelines is being attempted to be transmitted. I had a friend years ago who prepared for the job, after a stint in U.S. Army Intelligence communications, in Southeast Asia. He really wanted the job so that he could get paid for sitting around playing his guitar, while supposedly listening to broadcasts and checking for classified leaks or other 'no-nos'.

The OSI objective is to exclude what I call the Most Rational Alternative ("MRA")—the conspicuously missing third alternative which I have interposed between the Two Big Lies ("TBLs"), in the very narrow space in which the truth has been crushed almost to death. They carry this out by promoting the TBLs and excluding the MRA. I am expanding this third alternative, creating a Wedge of Reason, to be driven between the TBLs, to expose how the MRA has been buried, confused, ignored, excluded and obliterated by the TBLs, which are:

1. That flying saucers do not exist; and,
2. That if flying saucers do exist, they are extraterrestrial.

These two (false) options—propagated by two supposedly opposing factions—are unmistakably like an answer to a legal complaint in a lawsuit, in which the defendant first denies all allegations (a demurrer), thereby challenging those who allege the existence of flying saucers, to prove their existence. Having anticipated the plaintiff's (our) traversal of this denial, the defendant

(the OSI) enters the second false option, through "UFOlogy" groups, which is equivalent to the form of pleading known as a "confession and avoidance" (or "traversal"), which conditionally confesses to that part of the allegations alleging the existence of flying saucers, admitting that (if) they are true and exist, then the diversionary defense (the "avoidance"), traverses and moves sideways, completely off track from the original issues, by introducing the false and contemptuously frivolous idea of "aliens spacecraft". If one examines the complete past liturgy on this matter, they will see that it was the government which first introduced the "alien plea" at 1947 Roswell, as a fraudulent "dilatatory pleading" intended to expand the issues into irrelevant areas, to create delay, confusion, and wasted effort, and especially to evoke a response from us. This gets us involved in a dialogue over issues which are entirely impertinent, to exhaust our energy, and in summary, to completely avoid the merits of the issues, getting us absolutely nowhere for years insofar as the real truth is concerned, just as they planned. The fact that these two options clearly show the "badges of fraud" typical of a quasi-legalistic deceit, should have long since alerted rational thinkers to their design by a single control group, the CIA, on behalf of the IllumiNazis. The reason the options bear unmistakable similarity to legal pleadings, is because the CIA likes to hire lawyers, because the CIA thinks—as one official put it—that "...law school teaches a future employee how to think"¹. The frivolous, impertinent, long drawn out and dilatatory pleadings of the last 52 years, shows the indelible marks of "lawyers at work". And if sabotage of rational thought is your desire, by all means hire a lawyer!

The frivolous "prosecution", made on our pseudo-behalf without our consent, is joined by the ridiculous counter-allegations of the (Secret Government) "UFOlogists"—such as those regarding "advanced alien technology" and "abductions"—and the phony debate is protracted ad infinitum. Under the circumstances, these "pleadings", and all their spurious combinations and variants, are knowingly false and fraudulent, since their proponents have access to the truth, and fail to plead to the merits of the issues which they clearly seek to avoid, as a fraud upon us and the 'court of public opinion'. They also fly in the face reality, since they are inherently contradictory. There are no contradictions in reality, only confused facts and false premises. While the rules of civil procedure allow a defendant to make contradictory defenses, a knowingly false defense, entered for purposes of a sham, can be stricken by the court (of public opinion), and the defendant held in contempt.

One popular false (combination and variant of Options 1 and 2) option, posits 'terrestrial' saucers, based on "alien technology" which is so expensive and far beyond our comprehension that we should forget about it, or, since it is being shared with our government—so the story goes—we must wait until the government decides to 'share' it with us, their damned bosses. All these allegations are not only outrageous, but completely false, and people should wake up and realize that they have been hypnotized.

Options 1 and 2 are both repugnant, since any reasonable, knowledgeable person realizes that the distances to earth from the nearest habitable planets (perhaps millions of light years) is so great, that the 'alien' possibility is ruled out for frivolity, but (in the complete absence of the MRA), Option 1 is often accepted. This conclusion is fraudulently induced by the Secret

¹From the text of a speech of M.B.Wood, 9th Reg. Dir. CIA, to my law class, U.T. School of Law, 1966.

Government's heinous mind-control lies. Water skiing on the dark side of the moon? Really! More Big Lies, ad infinitum. Should I laugh or puke?

The way the UFOlogy field is controlled is obvious, and my knowledge of this is buttressed by actual personal experiences. If you are "on the right track", the O.S.I. gang pretends to befriend you. You naturally want to promote your material and your career, so you go along with it so long as the effects are positive. They invite you to participate in one of their "expos" as a speaker, to promote and sell your books or other materials, and to give a 'workshop'. If your stuff is still out of sync with their plan, they go to work on your mind. But if you don't abandon your stuff, or adapt it to their 'party line' and help them spread their phony shit, they blacklist you from speaking, and try to obliterate your message. They 'pick you up' and 'drop you', to coerce your adoption of their party line, so you will be asked to speak again. This only works on unethical people who have nothing valuable to say, or who are so weak and stupid that the party line looks feasible.

I: The Most Rational ALTERNATIVE

The third alternative—the "MRA"—is as follows:

3. That all saucers are real, man-made flying machines, invented and flown by human beings for over fifty years, there being no alien contacts whatsoever on earth.

This option comports with what philosophers call "Ockham's Razor" (a test which cuts between bullshit and reason). Furthermore, I reiterate that saucers are based on relatively simple, long-known electrical technology, consummated in the late 1930s, when technology was comparatively primitive. This alternative challenges the OSI/CIA to prove—through their agents and dupes—what it falsely asserts. They have failed to do so after over 52 years, and can be presumed to be liars and huxters (since "dupes" is reserved for civilians).

Since the OSI doesn't even want my MRA to exist, it will never be seriously or consistently argued by (their) proponents of the TBLs, who will not plagiarize me, or even risk addressing the issues. They have attempted to conglomerate some of my ideas with some of theirs, or to "steal my thunder", but the truth is not compliant to such a corruption of ideas. My alternative is immiscible with their lies, and even mentioning it would only create more self-contradictory ("repugnant") 'pleadings'. Like quicksand, the more they wallow, the lower they sink.

In my first version of SPACE ALIENS, I called the proponents of Option 1 the "Philip Klass Psychophants". I hereby dub the proponents of Option 2, the "Adamski Psyehophants". The OSI "Alien Abductions Hoax" of Whitley Strieber, Budd Hopkins, and Dr. John Mack of "Haaavad", is not a separate saucer option, but rather a part of Option 2, which is inseparable from its counterpart, Option 1, all of which are mutually repugnant OSI BIG LIES. Proponents of Options 1 and/or 2 are either.

1. Witting Secret Government agents and liars; or,
2. dupes.

Some truly innocent dupes are not stupid, just naive. Considering this, I point out the incredibly devious route the Secret Government takes to "manufacture witnesses". A case in point is a woman I later mention, Vicki Landrum, who may still believe that a NASA employee named John Schussler is her "friend". Schussler has been transferred to the OSI, and now propagates the abductions-by-aliens scenario. Landrum thought he had been "fired" by NASA for backing her up, but this was part of a "good cop/bad cop" routine, intended to create his 'cover'¹ as a 'sympathizer', in his new job with the OSI. Landrum is smart enough to figure it out. At the time Schussler sidled up to her, Landrum was in dire need of help. While pretending to help Vicki Landrum, Schussler was spying on and misleading her for NASA and the OSI, his new boss.

In order to understand all this, many need to do some self-assessment and careful examination of the facts, during the time they became unknowing tools. There are a few people who have just jumped on the 'UFOlogy' bandwagon, saying whatever it takes to sell books or establish themselves as "witnesses" or "abductees". Then there are those who were unwittingly used by the OSI, through the use of such drugs as scopolamine, chloral hydrate, sodium amytal, or even more exotic techniques and drugs, combined with hypnosis. The dupes are usually chosen by personality profile, epistemology (must be Platonist), religiosity (also Platonist), as well as possibly neurological abnormalities such as certain sleep disorders, any or all of which may render them especially vulnerable to the 'manufacturing' process. There is no guilt for having been conned

Dr. John Mack¹ sociopathically concentrates on narcoleptic patients. The "abductions" scenario came into general use around 1975 (just prior to the Travis Walton incident in Arizona), when the CIA realized their Old Big Lie program had become stagnant and needed a new, more bizarre twist. The scam incorporated new special effects, fancier props, better acting, better drugs, and more professional sets. A documentation of some of the inner workings of some of these scams was sent to me² in early 1994. In my first edition, I mentioned that a book had been stolen from me before I had an opportunity to read it, having forgotten its title and author, but in a phone call from author Walter Bowart, I was able to determine that it was a first edition of his Operation Mind Control, because it had a red and black cover, and was published in England. The female OSI book thief had lived with Dr. Jacques Vallee for two years, and was the same woman who stole two photographs (one showing three rhesus monkeys in G-suits, and the other showing a rather corny and poorly fabricated fake "flying saucer", in a hanger) which had been sent out to area newspapers by the Army Air Force Intelligence P.I.O., Walter Haut, in the initial Roswell Hoax. These photos, and my Peiltochterkompass, were sufficient physical evidence—originating with the government itself—to prove beyond a shadow of a doubt that the U. S. government had Nazi flying saucers, and had executed the Roswell Hoax to conceal their terrestrial origin, followed by the Pentagon's "Weather Balloon Hoax", designed to conceal the first (bungled) hoax.

Because of the connection between Vallee and the OSI she-thief, I had realized that the theft was engineered by the Secret Government, and now realize that the thief worked under Vallee, whose main job has always been to straddle the fence, continually vacillating between the questions, "are UFOs real?", "are UFOs illusion?", "are aliens here?", or "are UFOs secret

¹John E. Mack, Abduction - Human Encounters with Aliens

²Letter from Walter Bowart to Wm. Lyne, 1994.

government aircraft?" This is so they can maintain a balance between both sides of the phony debate, which does not even consider the fact that the UFOlogists and people like Vallee work for the CIA. Since my evidence could have tipped the scales completely off the balance, they had to steal it. They refer to such thefts as "retrievals".

For an intelligent person who has never seen a saucer, there is always the lingering possibility in the back of the rational mind, that they simply don't exist, like ghosts. Once a person has made a broad daylight, close range sighting, there is no longer any doubts as to their existence, and the person should be able to confidently proceed to solve the remaining questions, if not suckered into falling into one or the other side of the phony debate.

By the time I was eight years old (1946), I had already interviewed many reliable witnesses who had observed "flying discs" in the vicinity of Roswell (130 mi. N.W.) and Alamogordo (180 mi. W.N.W.), so I knew they existed, and had probably been brought under Operation Paperclip to Ft Bliss with Wernher von Braun and his 116 top scientists, in September, 1945, when von Braun was appointed Chief of Research, U.S. Army Ordnance¹. In the spring of 1947, I had caddied for my father's first 36 holes at the Roswell Country Club, and caddied another 18 holes there a few weeks later, in a professional tournament in which he was "first runner-up", winning a new Remington electric razor, and a set of Samsonite luggage. While observing the sky while waiting between shots and putts, I saw a few dime-shaped disks glinting in the sun, but wasn't sure they were flying saucers until my 1953 close-up sighting, in which the saucer departed in a trajectory directly toward Ft. Bliss, at c. 9,000 mph.

If there was ever alien contact, I would probably have known it, and if anyone has proof, here I am baby! Just hit me with the evidence (and I don't mean a bunch of government documents, or pseudo-interpretations of ancient Sumerian clay tablets)! I have been waiting a long time, and I'm still waiting, but I don't expect proof this late in the game, especially since I know any "proof" would be a fabrication of the OSI "MYTH FACTORY". If this statement seems blunt, I have no apology, and my feelings won't be hurt if you continue to insist on the Ridiculous Big Lies—that there are aliens from outer space, manipulating the human race—since I know these "aliens" are really Pentagon-created delusions, and that those of you who really think you believe the alien stuff have been made jackasses of by the OSI. Feel your ears growing longer? It is impossible to "believe" a lie. Why? Because, in order to "believe" something, one must have some "means by which they know it to be true". Since a lie is untrue, the means is non-existent, and what is purported to be the means, is first a lie to oneself, an agreement with the self to believe a lie.

To the witting agents out there: How does it feel to be a traitor to your people, who conceals technology which would improve the quality of your life and that of your children, and ultimately extend human life on this earth? How does it feel to be the pawn of a warmongering gang of mass murderers?

¹Current Biography. 1952: New York Herald Tribune, p 14 D 4 '46.

II: The O.S.I. Myth Factory

Many have never heard of the OSI, or are confused by the fact that there are at least three OSIs. The first one was the Office of Special Investigations, supposedly set up to investigate Nazi war crimes and criminals after WWII, and was appended to the Tribunal at Nuremberg and the U.S. Department of Justice¹. This O.S.I. was compromised by helping to protect or conceal many war criminals through its complicity with Operation Paper Clip. The second OSI is the Office of Special Investigations, USAF, which was set up to pretend to investigate "UFO" sightings, having as its real purpose the plugging of leaks about flying saucers connected to the Air Force. The third and most important OSI is the Office of Scientific Intelligence, a branch of the CIA's Science Directorate², Clandestine Services, set up to gather 'strategic' scientific information, to disseminate classified 'strategic' mis-and-dis-information, and to run programs designed for such purposes, which includes fomenting domestic "UFOlogy" groups and related hoaxes. Its most important function is plugging any and all leaks regarding flying saucers, by whatever means necessary, on behalf of its IllumiNazi bosses, and to prohibit the development of such resources by private individuals. This particular OSI was and is the most secret of the three, and use of the same "OSI" tag was probably intended to maintain this secrecy by confusion. It has worked pretty well until now. Imagine a group set up to protect Nazi criminals, named the same as one set up to prosecute them. The OSS and Reinhard Gehlen's Amt VI, SS RSHA had a baby, called the CM.

I have always believed that the purpose of all three OSIs involves the Nazis and flying saucers. The first OSI not only investigated war crimes, but also insured that independent post-war investigators looking into the Nazis, did not probe into flying saucer technology, or the secret technological and political deal entered into at the war's end, between the Third Reich, the U.S. government and certain CFR/Trilateral/IllumiNazi-owned corporations, all neatly concealed under Operation Paper Clip³.

The OSI maintains numerous teams of Ph.Ds. The procedures followed by these teams in the production of appropriate propaganda, are identical to those used in movie production or political campaigns. The scenarios for their scripts are based on the old pre-generated scenarios, as they apply to 'intelligence', gathered from the public, such as what writers like myself are saying, and the public's reactions. After evaluation of current intelligence, false propaganda counter-strategies to be used in the dissemination stage, are designed by OSI clandestine operations personnel. OSI think tanks' brainstorm on plans and proposals, to generate 'new' possibilities on the old themes which are used as 'guidelines', and some of these possibilities are incorporated in proposals. The writer teams then prepare numerous scripts, based on current strategies recommended by evaluators. Final proposals, including scripts, budget breakdowns, potential producers, production schedules, etc., are then reviewed, with approved projects advancing to the production stage. "Script writers" are chosen to 'front' the scripts, and money is provided to producers.

¹Victor Marchetti and John Marks, *The CIA and the Cult of Intelligence* (Dell, 1980-84).

²John Marks, *The Search for the "Manchurian Candidate"*. WW. Norton & Co., New York/London.

³1 (supra) compared to related information in Charles Higham's *Trading with the Enemy* (Dell, 1983).

Over the years, the OSI has created avenues into the Hollywood world and all other potential propaganda media. A review of previous Hollywood, or CBS/NBC/etc, productions, reveals that the OSI tends to use the same producers, 'writers', actors, and staff, to limit the possibility of leaks concerning their covert backing. A review of flying saucer propaganda history will show the method in their madness. Old scenarios are discarded, and new ones adopted. It is often in their interest to collect old propaganda, and to destroy it, so hang on to all the stuff you have, since old names, places, dates, and scenarios have a way of throwing a light on the present, to reveal the truth behind another Big lie. Besides, the future value of your old propaganda pieces as "collectibles" will only increase, as laughable examples in the future, of Big Brother's foiled attempts at mind-control of the public, through mass promotion of "parapsychology", the Platonist epistemology, and false "alien" and mystical science propaganda.

III: Gravity and Tesla's Work

Some of the most basic scientific facts and principles are being concealed and misrepresented, beginning in kindergarten, so we must each re-examine nature, and question all theories, in order to identify and reject scientific lies and omissions, and to rediscover and propagate "true science". About 1937, "science" and space propulsion became really schizophrenic. While Wernher von Braun ostensibly developed rockets, he covertly developed secret Illuminati flying saucers; while Albert Einstein's relativism and Werner Heisenberg's "uncertainty principle" were being publicized, the 'ether physics' of Nikola Tesla and others was being ridiculed, yet was secretly being used for saucer propulsion and wonder weapons so highly classified that they were never even intended to be used in WW II.

H. A. Lorentz had said that, by simply increasing the negative "moving" charges (orbital electrons), attached to the "stationary" nuclear charges (protons and neutrons) of atoms, that the gravitational attractive force acting on the positive charges of the nuclear mass would be completely neutralized. Add to this the constant conversion formula—which says that the electrical attractive force is 10^{39} x 2.2 times stronger than the gravitational attractive force G^1 —by which Lorentz had suggested a scientific hypothesis for an electrical flying machine, such as that already under development by Tesla and supported by his ether propulsion discoveries.

Tesla at first conducted tests² (the high voltage experiments relating to the high frequency reactance between two parallel metal plates), to verify his hypothesis. His tests confirmed that at sufficiently high voltage and frequency, the "space" (containing the ether) between the plates, became what Tesla termed "solid state", verifying the existence of what I call the "Omni Matter" (A.K.A., "the ether") which behaves under sufficiently high voltage/frequency "Tesla currents", as if it is a 'continuous, electrically conductive fluid', possessing mass, inertia and momentum, which can be 'pumped', to suspend or propel the plates in space). Tesla then carried the hypothesis a step further, and concluded that an electric flying machine could be propelled by electric current and the reactance of high frequency, high voltage electromagnetic waves. This electricity would use the

¹R.L. Armstrong and J.D. King, The Electromagnetic Interaction (Prentiss-Hall, Inc., Englewood Cliffs N.J.

²T.C. Martin, The Inventions, Researches and Writings of Nikola Tesla, The Electrical Engineer, N.Y. (1894).

inertia of the 'continuous, electrically conductive fluid mass' of the Omni Matter, to be pulled and pushed against, using the Hall effect magneto hydrodynamic ("MHD") principle.

The ether physics of Tesla was quite different from the theories of others, and was based on astute observations and sound experimental science. In 1876, H. A. Rowland had published the results of his experiment in which a gold foil covered ebonite disk was rotated in a magnetic field, showing feat electric charges on the disk were carried around with it as it was rotated.¹ This gave rise to the catchy phrase, "An electrostatic charge carried around is a current". Rowland's student in Baltimore, Edwin H. Hall, based on his teacher's work, had done an experiment in which he had placed a gold leaf strip in which a current was flowing into a magnetic gap, producing an electromotive force at right angles to the magnetic field and the current, proportional to the product of the two.² This is called the "Hall Effect", and we know that it was influential on Tesla, because he mentioned it many times, because it is the basis for MHD (Magneto-Hydro-Dynamic) generators and pumping, and was used by Tesla in his electro-propulsion.

In his 1891 lecture, Tesla stated that the "enormous electrostatic forces" emanating from the earth, "rigidifies" the ether within earth's electric field, as it moves through space "like a charged metal ball" (due, as he would later say, to earth's movement through space at over 70,000 mph.). To Tesla, the ether was composed of "independent carriers", "immersed in an insulating fluid"; while this ether behaves as a solid to "heat" and "light", it behaves like a "fluid" to solid bodies, which are allowed to pass through it.³ Furthermore, according to Tesla's analysis, a D.C. brush current could be used on the forward end of a ship, to create a "rarefaction" of, and "rapid exchange" of the carriers, which would stretch the medium and create an inducement of movement in that direction, while a high frequency alternating current would be used on the opposite, trailing end, to cause a "compression" of the carriers, which would block their passage.

According to the later researches and publishings of J. J. Thomson⁴, he had mathematically developed the theory of moving tubes of force. Two years later⁵, Thomson declared that "...the aether is a storehouse of mechanical momentum". Tesla, in his prior lecture⁶, had mentioned the tubes of force and disclosed some of his discoveries concerning the ether and momentum

Tesla had stated that all his inventions were created in furtherance of his "electric flying machine"⁷, which he had partially designed before coming to America, carefully carrying the plans under his arm when he arrived on the ship in 1883. The rest of his things were stolen on his

¹H. A. Rowland, *Ann. d. Phys.*, clviii [1876], p. 487.

²Edwin H. Hall, *Amer. Jour. Math*, ii [1879], p. 287.

³T.C. Martin, *Supra* (Chap. XXV, *The Scope of the Tesla Lectures*, p. 137).

⁴J. J. Thomson, *Phil Mag.* xxxi [1891], p. 149.

⁵J. J. Thomson, *Recent Researches in Electricity and Magnetism* [1893], p. 13.

⁶Nikola Tesla, *Lecture Before the AIEE.*, Columbia College [1891],

⁷Frank Parker Stockbridge, *The Tesla Turbine, The World's Work* [Mar., 1912, pp. 543-48].

departure for America. Though literally penniless at the time, his step off the boat was to be worth untold \$ billions to America, and he knew it

J. J. Thomson had stated in 1893 that if moving tubes of force entering a conductor are dissolved in it, mechanical momentum is given to the conductor, at right angles to the tubes and to the magnetic induction, and is proportional to the vector product of electric and magnetic forces.¹ Tesla's statement in 1891 that the use of high frequency alternating current would compress and block the passage of the tubes was apparently intended to force the tubes being drawn into the conductors of a ship by the D.C. brush at the opposite end, to dissolve in the conductors, and impart momentum to the ship to which the conductors were attached, in the direction of the brush. Tesla said he had developed his Dynamic Theory of Gravity in 1893 and 1894. He never published it, since to do so would have disclosed the secret to his electro-propulsive discoveries, which he did not want the war mongers to get. In 1942 and 1943, the FBI stole, concealed, or retrieved every known complete copy of the original theory. The theory can be pieced together only from bits and pieces, such as collateral references, in still-available sources. I will give the basic tenets of the theory in this book.

In 1915, in an unpublished statement², Tesla related his discovery, while in technical school in Graz, Austria, of "...a flying machine quite unlike the present ones...", "...devoid of sustaining planes, ailerons, propellers and other external attachments, which will be capable of immense speeds...", "...sustained and propelled entirely by reaction...", "...which will be controlled mechanically or by wireless energy". Tesla was never involved in rocketry, so these statements clearly referred to a different sort of electric flying machine, propelled by the reactance of high frequency electromagnetic waves and electric current. In 1900³, Tesla described how movement of the control apparatus could be effected, "...when they are carried by a vessel floating in the air...", by "...connection of one terminal of the receiving apparatus" to the ground, "...inductively". This pertained to how a flying saucer may be inductively ("virtually") grounded by the neutral or positive terminal of "p2". (NOTE: "p2" will be explained later in this book.)

In 1940⁴, Tesla announced his Teleforce, consisting of four already tested inventions, as follows:

- "(1) A means of producing rays in the free air without a vacuum;
- (2) a method of producing a very great electrical force;
- (3) a method of amplifying this electrical force; and
- (4) a new method for producing a tremendous electrical propelling force."

¹J. S. Thomson, Recent Researches in Electricity and Magnetism, [1893], p. 13.

²John J. O'Neill, Prodigal Genius (supra), p. 172.

³Patent No. 649,621, Apparatus for Transmission of Electrical Energy, lines 65-70.

⁴William L. Laurence, New York Times [Sept. 22,1940].

(NOTICE: Number (4) above stated "propelling" force, rather than "repelling" force such as some UFQlogy/CIA misinformants would have you believe, and also note that all four of these inventions were already tested at the time, rather than just the first two, as the CIA would also like for you to believe. In a Dec. 8, 1915 article in the New York Times, Tesla had brought up the same electrical propulsion system—except with a generator on the ground supplying electrical energy to an airborne ship via beam—which he said would travel over a million miles per hour (perhaps its potential velocity in outer space, as this seems exaggerated.)

To show you how insidious the misinformers are, and how easy it is for them to dupe sensation-addicts', there have been several recent instances where the misinformation regarding the four above listed inventions, from the original 1940 New York Times article, has been misstated in a sly and oblique way that few would suspect, right under the noses of the "Tesla experts". The four inventions were already tested at the time, and (4) was indisputably a propelling force. Anyone who ran down the original article to examine it as I did, would know that

Among the several places I have discovered this misrepresentation, was a so-called "patent" on HAARP (High Frequency Active Auroral Research Program). The only purpose for such a fraudulent misrepresentation would be for the explicit purpose of misrepresenting the original Tesla material, to those studying Tesla's work, because it represented one of the few 'unretrieved' leaks of Tesla's discovery of the flying saucer propulsion system. The patent¹ is now held by Arco Power Technologies, Inc., under which they purportedly perform "top secret" tests for the government, from the North Slope of Alaska. The patent is allegedly one of three patents previously locked up under a Navy security order. To begin with, patents are not issued on inventions primary to secret projects. Whatever the real purpose of the HAARP project, you can bet your booties it isn't what they say it is. Secondly, the real purpose of planting the false particulars in a 'patent' which should never have been issued, is so that the misinformation would end up in publications read by 'alternative researchers', to obscure and misrepresent Tesla's discovery of the ether propulsion system used on flying saucers. And who is ARCO? ARCO (Atlantic Richfield Oil Company) was created by Trilateral Commission/Council on Foreign Relations member Robert O. Anderson, of Roswell, New Mexico, the creator of Diamond A Cattle Company, the largest holding company in North America, which owns all known oil shale deposits in North America, and almost all mineral rights in the North Slope of Alaska. Anderson was also, at the time the second edition of this book was published, the President of the Bilderburgers, about which I will have more to say later.

Early on, during the 'fuel crisis' of 1974, Arco moved to garner a monopoly on solar and alternate energy resources, apparently based on a fear that the reactionary alternate energy movement could cut seriously into future fossil fuel profits. The misinformation placed in the 'patent', was repeated² just precisely where it shouldn't have been, but just precisely where the Secret Government wanted it. Once something like this gets started, where does it stop? Those

¹No. 4,686,605, issued to Barnard J. Eastlund, Spring, TeKas, 1983.

²NEXUS MAGAZINE, April-May 1995; EXTRAORDINARY SCIENCE, Jan-Feb-Mar, 1995 (official magazine of International Tesla Society, article by Dr. Nick Begich, New Uses of Tesla Technologies for global Control).

who should have known better, did nothing to stop it. Where the ball goes, nobody knows. We cannot allow this Trilateralist misrepresentation of Tesla's work to go unchallenged.

If we search the early inventions of Tesla (the later ones are concealed by the government) it appears that along with the Tesla coil, there were several related inventions such as generators and a marvelous turbine, intended to provide a compact and portable means for the generation of power needed on the flying machine---a "prime mover of sufficient activity"--invented to supply electrical current for the coil, as the fundamental device to increase the moving negative charges. This also explains Tesla's fascination for such a low weight-to-power in his turbine, using the motto, "20 Horsepower Per Pound", on the masthead for the "Tesla Propulsion Company". By "propulsion", Tesla included ether propulsion.

IV: Dealing with "Equal and Opposite" Forces

If the Tesla transmitter produced negative pulses which "preponderated" over the opposite pole of "p2", the question as to whether the "equal and opposite" forces would propel the saucer, depended on several things. Since the electrical attractive force is so much stronger than the G force, it would be conservative to conclude that a small amount of electrical power would be sufficient to propel a relatively large mass through space at an astounding speed, relying on the fact that all mass has excessive positive charge, and that the ether has sufficient positive charges and rigidity to provide something for an electric flying machine to "pull against", as it accelerated in a particular direction. This electrical attractive force is thousands of zillions of times stronger than the gravity force which pulls it toward the ground! Great care would be required in designing the shape of the flying machine's surface, since it might cause the acceleration of objects toward itself, as well as itself toward them. By use of a concave parabolic shape, for example, the electric force would be focused at the center of its radius, at a particular distance from the inwardly curved surface. On a machine of large mass, this shape could cause a smaller object to be jerked toward it with fantastic force. It could literally jerk a person's head off, were it located at the focal point of the parabola. If, on the other hand, one wanted only to "beam up Scotty", a carefully controlled, weaker force could be exerted with a small, parabolic dish of slight curve, pointed downward, in or on the bottom of the machine as it hovered, to pull an object (or person, or young bull), up into the machine.

An appropriately designed flying machine should have a reminded, gradually curved surface, to prevent the leakage of charges into the atmosphere as much as practicable, as well as to insure that the electric force would be dispersed and radiated outward over a broad area, so as to avoid focusing the force, and to diffuse it over a greater volume of space, containing greater mass (of atmospheric gasses, distant bodies, and the polarized, 'solid state', Omni Matter), so the smaller mass of the machine is, attracted forward or upward, with as little disturbance of atmospheric mass as possible. This was the reason for the many Tesla experiments with rounded conductor surfaces, his concern with atmospheric science, and his care to see that the elevated dome-shaped conductor for his Wardenclyffe Tower project was always positively charged (since a shot of negative pulses might have jerked it off its supporting foundation).

There are so many rounded surfaces in Tesla's designs, that it gave me cause to wonder why Margaret Cheney, in her Tesla biography, *Tesla: Man Out of Time*¹, using a passe', post-mortem Freudian psychoanalytic technique, alleged that Tesla had a near psychotic phobia of "rounded surfaces", evidenced by his revulsion and fear of pearls, based on an underlying "fear of the female breast". This hypothesis seemed belabored and misplaced, since Tesla's dislike for pearls appeared to be the result of his well-known phobia of germs, since pearls are essentially the result of a type of 'infection' in oysters. Could this sloppily surmised "phobia of rounded surfaces" be an O.S.I.-designed ruse to lead us away from one of the fundamental ideas of Tesla's flying saucer? Did Tesla really have an irrational fear of "the female breast" and "all breast-like shapes" ("flying saucers"), as Margaret Cheney said?

Quite to the contrary, many of Tesla's inventions are a glory to the breast, and a display of his apparati looked like a veritable garden of breasts, to be sure. Howard Hughes certainly had nothing on Tesla in this respect. The final design for his (originally "titty-like") Wardenclyffe Tower electrode, multiplied the titty motif literally hundreds of times, in different sizes! It looked sort of like a giant donut covered with bras. There is an unmistakable similarity between the Wardenclyffe Tower electrode, and early German saucers, presumably reflecting Tesla's original designs, which could just as well have been called "Flying Titties". "UFOlogists might have been called "Boobologists". Is the female breast shape the most perfect flying saucer shape? I have to conclude that I think Tesla loved the female breast, and other such shapes. I won't dwell further on this lovely issue; I should have made my point, so now I'll cut to the chase.

When Tesla died in 1943, few noted that a great scientist and inventor had died. It was as if he had scarcely lived, and that his only contributions were A.C. current generators, distribution systems, and motors. Before what I call my "Tesla Revival", beginning around 1976, there was an obvious attempt to conceal Tesla's place in history, which I believe was because he invented the flying saucer. The national security establishment wanted to dispel private Tesla research or experimentation, since the most fundamental discovery associated with him—the Tesla coil—was also the fundamental discovery used to power the flying saucer. It is still against federal law to operate an unshielded spark gap and Tesla coil, or a Ford Model T coil with a spark-gap. These laws, dating from the early '40s, are still on the books, and though ostensibly enforced by the F.C.C., I think they were really intended to prohibit civilian rediscovery of Tesla's flying saucer.

Tesla was irritated by Albert Einstein and his theories, and considered himself greater than Einstein. Why? The following comparison may answer this question:

V: A Comparison of Gravitational and Electrical Force,
As Applied to Flying Saucer Propulsion

The electrical attractive force is 1039 x 2,2 times stronger than the gravitational attractive force G. This equation is a constant, for converting from the gravitation to the electrical attractive force.

¹Margaret Cheney, *Tesla: Man Out of Time* [1981], Prentiss-Hall

Example: 1,000 ft. -lbs. of mechanical energy are required to lift a 1,000 lb. flying saucer to a height of 1 ft. above the ground. This is 1,356 joules (1 ft.lb.=1.356 joules). Divide this by the

above constant, to show that only a tiny electrical force will do more work than a 'conventional' mechanical force, such as that produced by rockets or propellers.

This is true for work is done by a constant vertical force F, and motion in a straight vertical line in the direction of the force. The work done on a body is defined as the magnitude of the force,

times the distance d through which the body moves. Inversely, the power produced by the constant

gravitational force G, acting to move a 1,000 lb. flying saucer from a point 1 ft. above ground, to the ground, would be 1,000 ft.-lbs. (= 1,356 joules, the same equivalent work required to pick the saucer up, against the constant vertical G force, to the 1 ft. height). Since the magnitude of electrical attractive force is the G force times the conversion constant, and the work performed on a body equals the force times distance, then:

$$W=fd, \text{ or Work} = (10^{39} \times 2.2 \times 1,356 \text{ joules}) \times 1 \text{ ft.}, \text{ or}$$
$$W = 40,492,781,690,140,845,070,422,535,211,091,549,295.77 \text{ miles.}$$

The above calculation would be true if the G force remained constant for that distance above earth, so it would be much greater, since there would be no gravity to overcome once the saucer was outside the earth's gravitational field. The work done by conventional energy, when converted in this manner, should theoretically do $10^{39} \times 22$ times more work, though in practice, there are inevitable losses, such as corona leakage and electrical resistance reflected as dissipated heat, etc, in the application of power (which, to be conservative, might amount to as much as 30%). In view of the vast increase in work, such losses are insignificant. This phenomenon is one of the fantastic tricks of nature which can be utilized through science, and its discovery by Tesla in the flying saucer, is definitely the greatest invention I know of. No wonder Tesla considered himself greater than Einstein! After all, the saucer is certainly more important than the atom bomb, though Einstein didn't invent the bomb, or anything else, for that matter, to my knowledge, other than Big Lie Illuminist Physics. On a positive note, what Einstein did invent, however, were many very sweet and 'profound' platitudes and anecdotes involving the archetypical "eccentric, genius, absent-minded professor."

VI: Momentum and Applied Force

Simply put, momentum is equal to the overall force required to produce a particular increase or decrease in the velocity of a particular body. The rate of change of momentum is also equal to the applied force. Since an applied electromagnetic force is so much stronger than an 'applied' gravitational force, the rate of change of momentum is also that much greater.

The force applied from a saucer, toward the ether in space, is emanated outward from a curved, convex surface of certain area, and directed toward a much greater area of space, containing an ether which is rigidified by the enormous, rapidly varying electrostatic forces emitted

from the earth, which as Tesla said caused the ether to assert its "inertia-resistance". In addition, there are atoms and molecules of matter such as gasses and water droplets which presents more of a problem than a solution. The total reaction between the saucer and the combined rigidified

etheric fluid and carriers (Omni Matter) is apparently more considerable than one would think. This is partly brought about by the saucer's shape, which determines how the force is distributed.

Though the saucer is a compact, more solid mass than the atmospheric gases and ether, the saucer is pulled at a high rate of acceleration. The real work done on the Omni Matter is apparently the result of the propulsive force created by the D.C. brush, as it eats up the tubes of force, which are forced to dissolve in the conductors by the high frequency blocking current at the ship's opposite end. The convex surface directs the force outward along lines which are perpendicular to the curved saucer surface. As the lines of force extend outward, they grow further and further apart, to affect a greater total volume of space and Omni Matter. Considering the density of vacuum space and the magnitude of the force, the interactance by astounding propulsion of a ship by the much stronger electromagnetic force, is the "equal and opposite reaction".

The etheric fluid and carriers in front of the saucer are 'stretched', creating a low pressure (ratified ether) 'cone', as the charges also cause the atmospheric gases to become mutually repellant. According to Tesla, "...on the assumption that the independent carriers are of any configuration such that the fluid resistance to motion in one direction is greater than in another, a stress of that nature would cause the carriers to arrange themselves in groups, since they would turn to each other their sides of the greatest electrical density, in which position the fluid resistance to approach would be smaller than to receding."¹ Tesla has described how the elastic force of the stretched ether has made movement in that direction easier. As the saucer accelerates to perhaps 9,000 mph., the shock wave is dampened by the low pressure cone, thus eliminating a potential sonic boom, as the gasses gradually return to plenum as the corona trail dissipates. The saucer's negative ion path and ejection of mutually repulsive Omni Matter to its aft, causes the low pressure gasses also to be mutually repulsive, preventing them from 'clapping' back together so quickly, such as with the booms and cracks caused by lightning bolts and thunder.

The saucer I witnessed in 1953 went from almost overhead, to infinity, in three seconds. It was between 35 and 50 feet in diameter. A rough calculation would be 9,000 mph., with no sonic boom or other sound, based on my being able to see it at 7.5 miles distance.

VII: Energy and Time

Neither energy nor time exist, since these are only fictions or concepts we have created, to measure, calculate or predict certain functions and reactions in and between space, matter, light, "zero-point radiation", "zero-point ultra fine matter", and cruder "atomic matter" (which may be only a concentrated assemblage of the latter). In 1963, I dubbed the ultra fine zero-point matter, "Omni Matter", saying it is the source of all atomic matter. This comports with Tesla's ether. "Electrical content" and electromagnetic force, in their most finite forms (ultra fine Omni Matter and zero-point radiation in space) are very closely related to light (both visible and invisible). It has been said that this made Einstein and other Illuminists very happy, since it appeared to bring physics and cosmology into consistency with their Kabbalistic, existentialist, Illuminist, Hermetic philosophy and religion. Time is a concept describing the rate at which events in the universe

¹T.C. Martin, *Inventions, Researches and Writings of Nicola Tesla*, 1894, Chapter XXV - Introduction - The Scope, of the Tesla Lectures.

occur. Since one cannot "travel" in a "concept" (which describes a "rate"), it should have been obvious that "time travel" is a physical impossibility, if not an epistemological and metaphysical blunder. The shadows on a cave's walls can deceive those who are content to sit and watch shadows, rather than venture beyond the cave, to discover the true nature of reality outside that little womb of false security.

'Objective reality', in the purely physical sense, may consist primarily of electric magnetic force and ultra fine neutral particles, which in turn, compose all atomic mass. Since 'gravity' is the result of electrostatic imbalances to the equilibrium existing between 'atomic' matter and ether-filled space, rigidified by the effect of rapidly varying electrostatic disturbances, in the space within the proximity of a gravitational body's electric field, a "super-gravity" force can be synthesized by creating an electric field stress which creates an even greater, overpowering disturbance to the equilibrium, which can only be restored by movement of a body so affected, until its position satisfies the 'equal and opposite reaction' rule. The movement of the saucer satisfies the imbalance created by the gobbling up and dissolution of the unidirectional tubes of force, which imparts momentum to the saucer, along the axis of polarity of the tubes force, in satisfaction of the 'need' created

This line of thinking seems to indicate how Tesla considered so-called "nuclear reactions"...electromagnetic reactions which produce powerful, very high frequency disturbances in the zero point "natural media", which react with atomic matter. These reactions are deemed 'stronger' than normal electromagnetic ones, since their disturbances are of such high force (voltage) levels, and of such high frequencies, as to react strongly (resonantly), with other atomic matter, sometimes to the "critical mass" stage of transmutation, such as that associated with thermonuclear explosions or implosions.

Meanwhile, the "zero-point radiation" ("ZPR") and Omni Matter interact at much higher force levels, yet to be fully measured. The spaces between the nuclear parts of atomic matter are comparatively so large, and the Omni Particles so small, in relation to the average amplitude of the ZPR, that the transference of force takes place right through solid matter, carried by the Omni Particles, as if atomic mass isn't even there. The use of the term "zero-point" is generally used to describe a system which is in equilibrium According to physicist J. A. Wheeler¹, the density of "zero-point energy" in vacuum-space is 1094 gram/cm³. (Note; This is purportedly the density of a cubic centimeter, and if correct, translates into humongous potential energy, right in the space at the tip of your nose.) I view "energy" purely as a potential, rather than something having an actual physical existence, as asserted by Einstein. I think Wheeler did likewise, since his measurement applied to the energy of "zero point radiation", not to the Relativist concept, "zero point energy".

Since I also am an adherent to the wave theory of light (rather than the "corpuscular" theory, or a contradictory combination of the two), I refer to the "omnidirectionally interpenetrating radiation" contained in "equilibrated" space, not as "zero-point energy" ("ZPE"), but rather "zero-point radiation" ("ZPR"). I also believe all space is saturated with ultra fine (normally) neutral matter (which also permeates all atomic matter). I refer to this as "Omni Matter"; This matter is activated by electromagnetic radiation which is not in equilibrium, transmitting its forces through Omni Matter/space until it is absorbed by some 'atomic' matter or body. Likewise, the

¹ A. Wheeler, Geometrodynamics, Academic Press [1962].

ZPR is able to interpenetrate almost all mass, because at such high frequencies, its tiny wavelength passes between atoms without resonating with or reacting with them. There is an exception. According to Tesla, so-called "radioactive" elements reacting to the ZPR (are "...targets" continuously bombarded by "infinitesimal bullets projected from all parts of the universe", without which "all radioactivity would cease"¹), which is the actual source of the radiation produced by them. There's something to think about: What is the nature of the structure or status of 'radioactive' elements, which allows them to react energetically with the ZPR?

It is my belief that during a body's movement through the space surrounding our earth, the independent carriers—the Omni Matter—, possessing independent 'tubes of force', are unified, creating continuously extended tubes of electric and magnetic force, which I call "micro-helices", swirling in parallel, tubular pathways through the body. A resistance (called "inertia") is experienced by a body, against the force of movement, with a polarity of movement, as acceleration progresses. There is a buildup of momentum (due to the very same mechanism as inertia). The inertia-resistance/momentum-perpetuation is encountered only with an increase or decrease in velocity, forcing the stubborn micro-helices into a different pitch (angle of turns) and frequency (turns per distance) of swirling electromagnetism, for each different velocity. There is no friction at a constant velocity, at which the ether "gives back" what it "takes".

As proof of this concept, the process can be reversed. By placing some paraffin in a "triax box", with a magnetic field of 10,000 gauss, the atoms of the medium are magnetically aligned, or 'polarized'. A high frequency electromagnetic field at 90 degrees, tuned to the nuclear magnetic resonance ("NMR") frequency of hydrogen...42.6 MHz..., excites the medium. This permits the hydrogen to react with the ZPR, to produce a (radioactive) beam of gamma radiation, which is far above the frequency one should expect from hydrogen. One can produce an output of electromagnetic radiation, magnetism, electric current, or "electromagnetic momentum", depending on the particular arrangement used and output preferred. With a hovering saucer, the electric field is externalized, with a current passing radially from the top center, across the predominantly horizontal area, and down the sides of the ship. A magnetic field automatically appears at 90 degrees to the electric field, and mass propulsion occurs on the third (vertical) axis, as utilized in Hall effect pumps. The downwardly directed beams of radiation seen on flying saucers may be due to the production of temporary radioactive isotopes of extremely short half lives, which emit photons as they return to their ground states.

Since a permanent magnet is composed of a medium (iron, usually) which has been magnetically aligned or polarized, some of the interpenetrating ZPR is arrested and separated into electric and magnetic components, and converted into magnetic flux, which is really a kind of "radioactivity". The ZPR is the driving force behind this flux, which is strongest when aligned with the earth's magnetic field, which in turn has polarized and converted some of the ZPR near or in the earth. The force of the flux will in turn separate moving positive and negative electric charges, more or less as the reciprocal of the mechanism by which the force of the ZPR has been diverted to create the magnetic flux. A permanent magnet can also be thought of as a "magnetic flux superconductor", which like an ultra high frequency antenna, receives the ZPR and produces a magnetic flux.

¹Nikola Tesla, Letter, New York Times [Feb. 6, 1932], p. 16, col. 8.

Use of permanent magnets by Tesla, across a spark gap discharge, was intended to use the Hall Effect to break the discharge, by separating the positive and negative charges, in order to produce a more perfect sine wave. Inadvertently, Tesla discovered that electric spark discharges in air, ignite and combust atmospheric oxygen and nitrogen, producing 12-million-volt waves. The oxygen and nitrogen, both, below atomic number 19, are thereby transmuted into alpha and beta charges (stripped helium nuclei with +2 charge ea., and electrons with -1 charges ea) by the powerful radiation produced, having a voltage potential of 12 Mev. Since this is almost three times the Mev level of gamma radiation emitted by radium, it is certainly sufficient to explain the claims of Tesla, as traditional contemporary physics cannot explain such high voltages or radiation.

In an ancient application of this same principle, there were ceremonies carried out in the underground kivas of American Indian tribes in the southwest. Small, white, hand-held, rounded quartz boulders (around 2 lbs. ea.), were held in pairs, by each of a circle of men, and struck together in the dark, to produce powerful electric spark discharges. Such rocks were called "thunder stones" by the Southwestern Indians. You may notice some similarity to the Norse myth of Thor ("Hare", meaning Osiris), with his hammer. This similarity was not coincidental, since the Indians called the Great White Hare Waban, an incarnation of the eastern dawn that brings light¹ (which comports with the Norse Odin and Saxon Wotam, literally meaning "east dawn "). The spark discharges produce bright light, and when many are simultaneously struck together, it is enough to light up the kiva, just as the Zuni ("Sun-of-Nu") Ahayuda' ("East-Hare (of) Light[ning]") was thought to do. The Zuni war god can only be carved from the trunk of a cottonwood tree which has been struck by lightning, and a lightning bolt is displayed on the carvings. The same thing holds true for the Assyrian ("East-Hare-People" or "Aryan") Ahuramazda ("East-Hare-of-Good-Light"), the carvings of which also display lightning bolts. During these southwestern Indian ceremonies, the unmistakable smell of ozone fills the air, and perhaps the "laughing gas" produced by the sparks, which ignite oxygen and nitrogen and form nitrogen oxide, makes one giddy, euphoric, and intoxicated..

VIII: Thor's Model T Coil

In my 1979 search for scientific salvage, I found a Peiltochterkompass (German, for "Polar-Slave-Compass"), in a pile of salvage from Sandia Base, in Albuquerque, which turned out to be classified salvage sold to a private dealer, who had bought the stuff without knowledge that the government employee had stolen it from a classified salvage heap at Sandia Base, then sold it for his own profit. The device was part of the celestial or inertial guidance system developed by the Germans in 1943, for navigational use on the Kreisel Teller (German for "Gyrating-Plate"), more popularly known as the "flying saucer". Also in that pile of classified salvage, was an old Ford Model T ignition coil (an invention of Tesla), along with a couple of the kind of ignition coils used in chemistry labs. In retrospect, I have decided that the Peiltochterkompass and other items may have been clues placed there intentionally, and that perhaps someone expected me to interpret their use. I have a hunch as to who that "someone" may have been—perhaps an old friend from long ago—but I won't dare to mention the name here. The ignition coils suggested ignition of the

¹Iron Thunderhorse, The Mysterious Dawnlanders, ANCIENT AMERICAN [July/Aug., Sept/Oct, 1997], Issue #19/20

two or more chemical components—such as oxygen and nitrogen—to create a nuclear/electromagnetic reaction from elements commonly existing in the atmosphere. The Model T coil is an interesting gadget, since it contains a Tesla coil, combined with capacitor and a 'Faraday buzzer', which converts D.C. current from the battery into high voltage negative pulses. The Faraday buzzer was a substitute for a spark gap. All that is needed for operation is a battery. Tesla may have powered his prototype flying saucer with a battery powered Model T coil, and may in fact have originally developed the Model T coil for that specific purpose. Tesla would often invent a particular gadget for his saucer, then 'turn it around' and market it for ready cash when needed, in uses more adaptable to the relatively archaic technology of the contemporary market place of his day.

In 1948, when I was ten years old, I belonged to a 'ham' radio club. I built a ham transceiver and had my Morse code up to speed for the qualification test, but was disappointed to learn that, at that time, under federal law, I could not take the test or operate my transceiver until I was 16. Consequently, a more startling fact I discovered, was the federal law prohibiting use of a Model T coil with a spark gap. The law appeared to come into existence contemporaneously to flying saucer technology, and the coil produces a series of negative pulses. The conversion formula indicates that it might be adequate to propel a small, man-carrying saucer, such as the early electrical prototypes in which Tesla ventured out of his New York City hotel window at night, making nocturnal excursions over the city in a machine he called his "flivver" machine, which was described as being about the size of a "gas stove"¹. This astonishing scenario must have been what scared the hell out of the oil companies. Most researchers have erroneously associated Tesla's "flivver" machine to the VTOL-type airplane which he patented in 1928.

When we observe a hovering saucer on a windless day or night, a large electrical flame is often apparent, spreading around the saucer, and growing in size the longer the saucer remains in one spot. This is because the initial high voltage 'leaders'—like electrical spider webs—begin to break away from the saucer's surface, ionizing and igniting oxygen-nitrogen combustion in the atmospheric gasses. Many observers mistakenly believe that these 'lights' must represent electrical losses from the saucer power system, but this is inaccurate, since the saucers' electric discharges are only the "matches", which ignite the gasses, which in turn burn so brightly. On windy nights, saucers hovering high in the sky flicker like candles in the wind, from the action of the wind periodically blowing the corona flames around on the hull. In a quiet and windless sky, the saucers may hover with a steadier, brighter glow, which is similar in appearance to, but distinguishable from a star, by a skilled observer. All the visible phenomena of saucers are consistent with this analysis.

IX: Work and Energy

The saucer propulsion system appears to operate "over unity", as a "free energy" device. The "Law of Conservation of Energy" is said to be "violated" by a device which operates "over unity", but this interpretation is false when properly analyzed, especially when considered in the light of devices which utilize fuels or forces already existing in ambient reality, to perform work. In fact, all

¹Microfilm letter, Nikola Tesla to Westinghouse Co., July 7, 1912, Library of Congress.

energy processes are ultimately derived from "ZPR", but the great majority of ordinary processes used in the 'archaic technology' forced on us by the coercive monopolists, waste so much energy that they operate well below unity. The false interpretation of the law of conservation of energy becomes obvious, when going from weak gravitational to stronger electric and electromagnetic, or even nuclear reactions. The question seems to hinge on a definition of "fuel", its origin, and in what form does the fuel for a particular reaction enter into an event. There are several forms of 'fuel' which appear to have been intentionally obscured. Just exactly how does a permanent magnet remain "energized", without any obvious fuel or "input energy"? Formal physics plays with words, accepting certain definitions of "energy", then canceling those definitions selectively in the case of such things as magnets.

Energy is defined as "...the ability to do work", and the accepted formula is that "work equals force times distance". We know that a stronger force will do a greater amount of work on a body over a given period of time, than a weaker force will. The "law" is not violated, where one converts a weaker force into a stronger one, and does a great deal more work, even though there are usually losses in conversions, and even though no more 'conventional' energy is added to the process. A powerful rare earth magnet will do more work than a conventional iron one, especially since the electric field required to cancel such a strong field is much greater, and this will be a measure of the output.

Fools will immediately blabber that "...this is impossible, because it violates the law of conservation of energy", and that there is a 'difference' between "force" and "energy". Really? Then why do they fail to delineate just exactly what that alleged 'difference' is, and how the 'force' of a magnet is any different than any other force which does work? They are fundamentally wrong in this case. In 1963, a physics professor told me that a magnet "did no work" when it pulled a steel ball across a table top. The force moved a body (the ball) over a distance. The work performed, measurable in standard units of "energy", conformed to an accepted definition of "energy", the same one used by the physics professor in class. I rejected the tortured route of false reasoning intended to counteract my statement of the above, and the physics professor was exasperated.

A weaker force—the alleged 'gravity' force between the iron in the magnet, and the steel ball—would not have pulled the ball across the table top. The weaker G force was dominated by the stronger magnetic force. Gravity also does work (remember Niagra Falls?). There are large discrepancies in supposed applications of the "laws of physics", yet it is generally agreed that "energy can be neither created nor destroyed, but only changed in its form". This statement is completely consistent to the "free energy hypothesis". We know that ZPR exists in a volume of vacuumized space, also filled with ether, otherwise a vacuum tube would not allow discharges. This applies to the space all around us here on earth, together with around 26 atmospheric gasses. We have the gasses and atomic matter, in addition to naturally existing ZPR and Omni matter, to work with, requiring only that we use appropriate means to simply convert the weaker forces to the stronger ones, rendering them "usable". In reiteration, we only need to polarize the radiant effects and separate and extract heat, other radiation, pressure changes, electric content, or magnetism, to do work. As a "magnetic flux superconductor", a common magnet most likely collects the ZPR in something like a 'reversed' K-capture phenomenon, and converts it to magnetic flux.

The use of permanent magnets to produce electricity in 'over unity' devices, has not yet really come into its own. The (Hans) Coler "Stromerzeuger"¹ (a "magnetic flux device", developed 1926-45) was a step in the right direction, and might have produced enough electricity to power a saucer, since the conversion constant shows a small current should suffice. It was not taken under development by O.K.M. until Jan. 4, 1943, too late for the Kreiselleller-p2 Projekt, which appeared to use a helium reactor, and the German saucers had been flying since as early as 1936.

Atoms of iron are a 'medium' which have a peculiar capacity to capture and convert ZPR into magnetic flux, which is always a secondary product of current. This means a magnet polarizes and unifies the tubes of force associated with the independent ether carriers. In the manufacture or formation of magnets—either in industry or in nature—the atoms (or molecules) of very hot or molten iron, which are in a state of flux, are aligned by an external magnetic field or electric current, whereupon the atoms are cooled and 'frozen' in aligned state, in a semi-permanent population inversion. Since the magnetic field remains when the external electric or magnetic field is removed, a magnet exists in an unbalanced relationship, 'needing' an electric field or current to accompany it. This imbalance continues because the magnet apprehends the magnetic portion of the ZPR, exposing its electrical portion, disturbing its equilibrium, wherever magnetic flux permeates. By alternating a magnetic field perpendicular to a pole-piece, or alternating an electrical current at right angles to a pole piece, an iron core will oscillate magnetically, producing rising, saturating, falling, and reversing magnetic flux which may then be used to create alternating current in inductance windings. The potential for these processes to operate ova unity is not generally understood or accepted, though there are numerous ways to operate electric and magnetic devices in ways violative of the law of conservation of energy, according to the version misinterpreted by the power cartels and their dupes in the field of science.

It stands to reason that if energy is the "ability to do work", and work equals "force over distance", that energy equals "force over time". These distinctions have been obliterated and concealed by the Illuminati, which has taught us to view energy as something which comes out of a gas tank and is "used up"

X: Forces and Fields

All forces create fields, and vice-versa. Some fields in nature may be unknown in specific detail. For example, we know that certain crystals can alter the frequency of radiation (the "Raman effect"), but some aspects of the process remain unexplained. Electric and magnetic fields, in relation to aligned crystalline molecular structure, are the known fields involved. Since I have not fully developed my opinions regarding crystals and sub-atomic physics, I say no more in this respect, except that crystals generally appear to be transducers of electromagnetic radiation.

Crystals are indeed fascinating and of scientific importance and interest, but have nothing to do with saucer propulsion. Beware of being side-tracked by huxters spewing slyly false OSI propaganda, designed to divert you into pseudo-scientific theories of crystals, so you will neglect your pursuit of saucer propulsion secrets. While it is conceivable that crystals could be used in

¹See Dr. Franklin Kilpatrick's Free Energy Secrets! (regarding a 1946 declassified report of Brit Intel. Objectives Sub-Committee).

some peripheral way to produce or control electrical energy to power a saucer, such as a frequency detector, they are not directly involved in producing so-called "anti-gravity propulsion", which is really an electromagnetic magnification and redirection of the so-called "gravity force". I call this "Electropulsion" or "Super Gravity" (also called "electromagnetic momentum" by J. J. Thomson).

Private citizens can do experiments with a minimum of equipment, with exciting prospects. It is often assumed that government/corporate scientists have already explored all possibilities, and that we would know of any important discoveries. But just think about it Patent protection lasts only 17 years. Is some corporation which has existed for over 100 years, going to disclose a discovery which will put itself out of business, liberate people from its power, and render its mineral assets practically worthless, in only 17 years, when they have already projected their future earnings from fossil fuels for at least the next 100 years? How else to guarantee perpetual oligarchic, socio-economic monopoly, acquire and hold ready-made mineral fuels and derived chemicals, while shutting off all avenues of alternative energy, chemicals, and raw materials?

The cartels will riot sit idly by while some "two-bit inventor" produces and markets a device which will demolish their business in 5 years, but will move by hook or crook to nip it in the bud. They will continue to get away with it, as they always have, unless we prevent it and break the cycle of abuse. The only way we can beat them is to make free energy inventions publically available, and pass our technology all around, so that everyone can use it. Otherwise, they will hunt down the information and destroy it, along with its authors. It is indeed ironic, that the inventor's desire to protect his discovery through secrecy, and the patent office's required secrecy, enables a corporate "stainless steal". There is no protection in the law for an inventor of such a device, so it just as well be given to everyone. As stated in Chapter I, the inventor should make a discovery public domain, to nullify any future corporate theft, and to manufacture and sell the invention, rather than go through an exhaustive patent application providing the cartels with advance notice enabling them to steal the discovery through the patent office.

Was it not the failure to reproduce and spread valuable knowledge everywhere, which was the greatest mistake of the ancient library at Alexandria? Where the greatest knowledge of the ancient world was collected and virtually concealed in one place, practically all of it was destroyed there, by religious fanatics. This destruction set human technology back about 1500 years, and paved the way for the Dark Ages, during which the only people allowed to possess, develop, or experiment with advanced scientific knowledge were the alchemists, who were exclusively employed by the ruling elite and bound by secrecy. Those who violated these boundaries were burned at the stake or impaled as witches or sorcerers. Today they are prosecuted into insanity or oblivion by the FCC. Has anything really changed? Let's change it. Spread all your secrets.

Small and non-energy-related inventions can be successfully patented and marketed without Illuminati interference, so long as they represent only a tiny fraction of the marketplace. Anything dealing with energy or transportation however, will be met with severe suppression and theft by the cartels. The typical delusion of the neophyte independent inventor, of receiving a vast fortune from such inventions, will only lead to incredible pain, after he has exhausted all his resources

¹William R. Lyne, OCCULT ETHER PHYSICS: Tesla's Hidden Space Propulsion System and the Conspiracy to Conceal It [1997,1998],

seeking "patent protection". It is time for us to spread all the suppressed technology we know of among the people, and to concentrate on manufacturing durable goods of high quality, just the sort of things the cartels hate. Inventors should devote their time spreading, trading and acquiring advanced, free energy technology, developing and initiating production techniques and creating facilities, as quickly as possible. We should also avoid La La Land-type pseudo-science of the type "encouraged" by the Illuminati.

Some will jeer that, if we have such technology, why aren't we using it? I've got news for these naive people. We are using it, and they are using it, but the public doesn't know it. In addition, we are paying for it, while the public service cartels pretend to be generating power with conventional technology, and are being unjustly enriched. A secret free energy system was built into our public electric utility system, by Nikola Tesla. We pay the cartels for electricity picked up 'along the way' to our houses, from the earth-ionospheric source, by the poles, and from the ZPR and Omni matter source, by the electromagnetic fields around the transmission lines. Even more current is generated by the meter on the sides of our houses (a Tesla invention which will function as a meter, a generator, or a meter and generator), depending on the particular equipment and hookups used. This secret is so well guarded that even few high ranking public service employees are aware of it.

If the kilowatt hours used in a region serviced by certain generators were accurately calculated, the total usage would probably far exceed the power produced by the generator stations. We are told by the 'experts' that energy is lost, but Tesla said otherwise. Each power pole is an antenna, having a copper grounding plate underneath it, and adds electric power from the earth-ionospheric source, to the power grid. At your house, the electric meter generates even more power, as it also reads your "consumption". With certain alterations, a Tesla electric meter can generate as much power as you consume and it can measure, perhaps even more. Differently oriented, the electric meter was originally one of Tesla's secret inventions, used as an extremely over-unity free energy generator, rather than a meter. I have tested this, and I know it works. Tesla's statement as to its potential output was so large that I won't mention it, for fear you would call him a "nut".

These inventions are based on standard free energy or ether theory. Radiation and matter exist in a state of self-restoring equilibrium in which all reactions tend to equal zero, with equilibrium being self-restored when disturbed. This tendency to become restored is related to the energy potential existing in free space, being a property of all matter and radiation. Since free universe is a perpetual motion system, energy, per se, does not exist, and all "work" is done by perpetual universal forces which exist in the environment.

Radiation does not move through space, but is the result of electrical and magnetic disturbances from stored sources emanating into the zero-point system at various points, which activate and polarize the normally neutral Omni Matter, causing transmission in chain reactions, carrying the electromagnetic oscillations from a multitude of points A, to a multitude of points B. The Omni Matter is so fine that it is capable of super-transmitting electromagnetic disturbances, from particle to particle, at all frequencies, simultaneously, in all directions, while self-restoring its own equilibrium. If we conceive of Omni Matter as tiny, identical globes composed of intertwined positive and negative bundles of electromagnetic force in equilibrium, densely packing all space like grains of sand, while ZPR simultaneously vibrates through it in all directions, it is possible to understand how equilibrium is maintained by the omnidirectional ZPR, and how

ALIENS35

equilibrium can be upset. The equilibrium is upset by polarization of this omnidirectional vibratory mode, and 'energy' (the exertion of force through distance) may be extracted from or injected into the Omni Matter and the ZPR, via a proper medium of exchange.

What one may perceive as "light, moving through space", is an electromagnetic fluorescent reactance of matter, as the forces excite it at particular visible frequencies related to the fluorescence-frequencies of the surface atoms of illuminated visible objects.

The trick is to disturb the equilibrium with a minimum of input, then to appropriate the 'restoring' energy, on a continuous basis. Low frequency electromagnetic forces which are transmitted into the system, are transmitted through it very efficiently. Whenever the frequency is increased until it creates disturbances in atomic matter—tending to re-establish its equilibrium—"atomic energy" may be produced. The potential for matter to be "worked upon" by electric, magnetic or nuclear force, is called "energy". Whenever a physical body is forced against another body, electromagnetic reactions, binding, attracting and repelling forces between the atoms and molecules of the bodies are stressed. The object with the greater momentum usually forces the other body to move or to come apart. On the microscopic level, force is imparted electromagnetically. "Energy" is always an abstract future contingency, which has no present existence in physical form. It is not a substance, and cannot be equated with a substance, but is a property of atomic, electric, magnetic, or electromagnetic radiation and reactions, which occur under certain conditions.

In order for the equilibrated forces of ZPR and matter to be synthetically apprehended for the performance of useful work, a quantity of specially chosen matter (or 'medium') may be placed in a "triaxial box", and subjected to electric, magnetic, or electromagnetic forces (emphasizing that so-called thermal or nuclear forces are really material reactions to electromagnetic forces).

A confusion between "energy" and "force", in conjunction with a false interpretation of the law of conservation of energy by their scientific dupes, allows the Trilateralists/CFR/Illuminati to conceal free energy and Super Gravity technology secrets from us. We no longer need for them to tell us the 'secrets', because the secrets are out. We must apprehend and use this technology to throw off the parasitic CFR.

Nikola Tesla's discovery of high frequency radiation and its use in the flying saucer, was his greatest contribution to the world. An oscillating electromagnetic wave has a frequency, which is the number of "beats" per second, with which the electromagnetic force is delivered. Within a system, an increase in frequency also increases the voltage or force of each beat, yet this requires no greater power to do so. Visualize a person beating a rug with a certain force, at the rate of one stroke per second. Now visualize that person bearing the rug 10 times per second, at twice the force. Naturally, the results for a given time will be greater, yet with electromagnetic radiation, no greater power is required to deliver 20 megahertz, than 20 kilohertz, yet the force (voltage) of the former, is greater per beat, as well as the number of blows per second. It is this phenomenon which causes the power radiated by an oscillating electromagnetic dipole, to increase at the fourth power of its increase in frequency. This is called the "reactance", and it is exactly what Tesla had in mind when he announced the completion of some tests of his electromagnetic (saucer) propulsion system, in 1940, though he tested it as early as "many years" before 1912, to be specific, in 1894. I call his system "Super Gravity". It is "public domain", because of its unpatented secret use by the government for over one year.

ALIENS36

Tesla distinguished between six kinds of electromagnetic waves, forces, and particles in space, which are:

1. "The Ether", composed of independent carriers immersed in an insulative fluid, permeating all space and matter, and from or to which all matter is ultimately composed or decomposed;
2. "Primary Solar Rays" ("starlight"), electromagnetic waves which travel at C, generated by our sun and other stars—having frequencies far above X-ray, gamma and U.V. rays—which comport with the ZPR;
3. "Cosmic Rays", particles in space, propelled by the Primary Solar Rays (ZPR), and which, depending on the voltage of the propelling ZPR, can greatly exceed C;
4. X, Gamma and U.V. electromagnetic waves, which travel at C;
5. Ordinary visible and I.R. electromagnetic waves, which travel at C;
6. Rapidly varying electrostatic force of enormous potentials, emanating from the earth and other gravitational bodies in space.

It should be noted that the ether is not "radiation" or an "energy source", but rather particles ("matter") which carry momentum, magnetism, electricity, or electromagnetic force, and which can be manipulated artificially or by nature to materialize or transmute any form of matter. Tesla did not believe in the interconversion of "matter and force" ("matter and energy"), saying "...without matter there is no force and without force there is no matter."

XI: OCCULT ETHER PHYSICS

For a more extensive exploration of this subject, consult my book, OCCULT ETHER PHYSICS: Tesla's Hidden Space Propulsion System, and the Conspiracy to Conceal it, © 1997, Wm. R. Lyne, \$8.00, ISBN 0-9637467-2-3, (Second Edition 1998, ISBN 0-9637467-6-6), Wm R Lyne, CREATOPIA PRODUCTIONS, General Delivery, Lamy, N.M. 87540.

Under Operation Paperclip—with full authority from Admiral Doenitz, the German high command, Reinhard Gellen's Amt VI SS RSHA (including General Otto Skorzeny, whose documents bought his freedom and much more) and every German high-level technical and political authority, including Hitler—all flying saucer "documents" of Germany went into CIA (OSS) hands in 1945. All documents relating to flying saucers and some other things, including the real terms of the "surrender", since declassified, are either fake or altered, to confuse and obscure Tesla's discoveries, which I call "occult ether physics", since "occult" means "hidden".

Ether effects may be metaphorically conceived as "interdimensional", since invisible ether is incorrectly thought to be imperceptible, but inertia and momentum are perceptible in 'our' dimension, which they are part of. I use the 'other dimension' reference only because fifty years of brainwashing has obliterated human consciousness of it and many other things in reality. I present it that way to soften the initial effects of facing reality. We perceive the ether effects both physically, feeling inertia and momentum in our bodies as we move, and visually, seeing the effects on objects and life forms as they resist movement, accelerate, fall, tumble, bounce, and come to rest.

Ether physics is the most carefully concealed ultra secret technology of the Illuminati, and is the 'real' physics. The academically accepted stuff, where conflicting with true ether physics, is a cover-up for the 'real' thing. Again, the answer is right under our noses, masquerading as 'insignificant effects' or 'anomalies', such as the Hall effect, as illustrated by a magneto-hydrodynamic pump. An electric current creates a magnetic field at right angles to itself, with polarity ascertained according to the "right hand rule". Fields each have two components. The electric (+ and -) and magnetic (N and S) fields occupy two axes. The third axis, for lack of better terminology, I call the "reactance field" (the two components of which I call "ether-in", and "ether-out"):

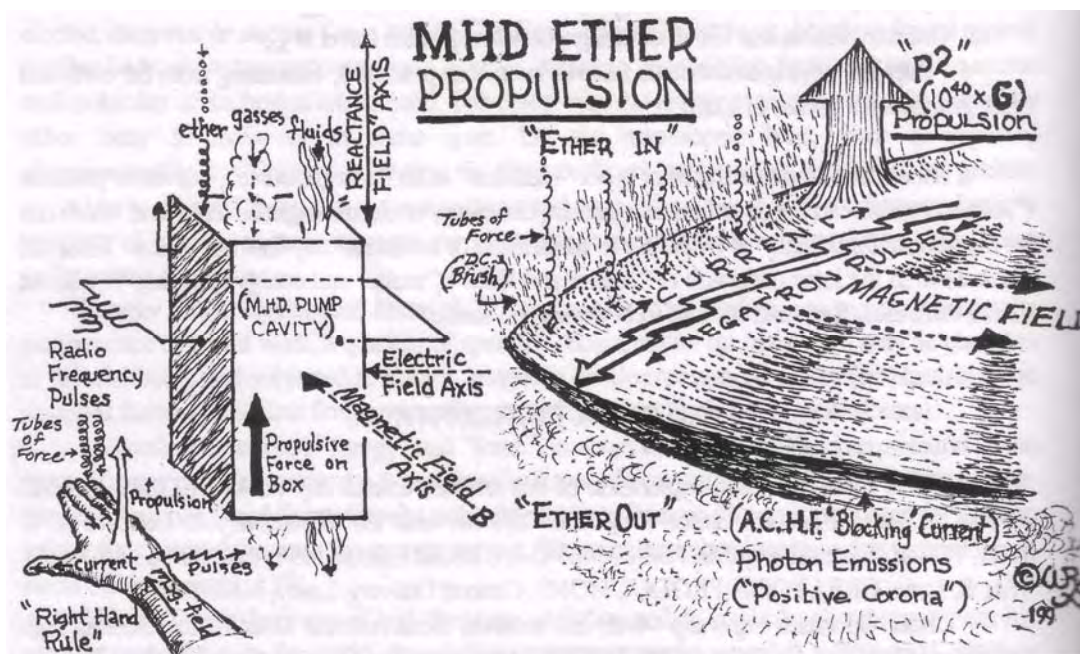

(NOTE: The theory I propose as Nikola Tesla's, is different from others known to me or patented by others, such as the "M.H.D. Propulsion Apparatus" of J.F. King, Jr. (Patent No, 3,322,374, of 5/30/67), or patents No. 3,120,363 issued to Hagen, and Nos. 2,949,550, 3,018,393, and 3,022,430 issued to Thomas Townsend Brown. These were all atmospheric "ion thrusters" or "reaction-thrusters" according to Newton's third law of motion, were feeble, and not for outer space. The King patent used AC rather than D.C. fields. These devices relied upon feeble "equal and opposite reaction forces" of the propelled masses of electrons and atmospheric ions, much like an airplane relies on pumped air. An accelerated electron will travel only about 4 cm. in the atmosphere. The ions are limited to those near the surface of the ship. No patented invention powers the "flying saucer". This (my) design pumps the ether, reaches into space and 'climbs' through it like a stationary ladder, and is unpatented because it is classified)

ALIENS38

A BRIEF HISTORY OF ETHER PHYSICS

Research in ether physics was seriously pursued from the early 17th century almost to the middle of this century, by the greatest minds in science and experimental philosophy. The following is a brief accounting of the main contributors and their theories:

Rene Descarte (1596-1650) - a. A dynamic vortex ether;

b. a theory of celestial vortices.

Johann Bernouille (1667-1748) - Deduced Kepler's laws from Descarte's vortex theories.

Isaac Newton (1642-1727) - a. Mathematical theory of gravity;

b. corpuscular theory of light;

c. free space completely empty.

Michael Faraday (1781-1867) - Electric, elastic solid ether (Tesla's later theory based on this).

G. C. Maxwell (1831 -1897) - Ether vortex theory revived in electromagnetism field.

George Stokes (1819-1903) - Dynamic ether (reconcilable with Descarte's ether vortices).

HA. Lorentz (1853-1928) - Theory of a quiescent stationary ether (C.F. Krafft called it "stagnant" and a close forerunner to the Poincare-Einstein theory of relativity).

Michelson-Morley Experiment (1881) - Proved already weak Lorentz theory wrong, and inconclusively forced a choice between:

a. a dynamic interstellar ether ala Descartes and Stokes; or,

b. empty space without ether ala Newton and Einstein (the prevailing theory).

Nikola Tesla (1856-1943) - 1893-94 Dynamic Theory of Gravity, based on Faraday's "electric elastic solid ether", and J. J. Thomson's "Electromagnetic Momentum":

a. All bodies have electrical content, mass a product of ether swirls;

b. dynamic, elastic ether composed of independent carriers in an insulative fluid, which permeates all space and all bodies;

c. movement of bodies generates microwaves (electrostatic forces) by inductance principles;

d. microwaves rigidify the ether within a body's electric field;

e. movement of bodies through rigidified ether, containing tubes of electric and magnetic force, creates gravitational interactance.

20th Century Ether Vortex Theory - a. Hydro mechanical ether without atomic oscillators (no ordinary frictional viscosity);

b. 'idealized' quasi frictional viscosity;

c. polarity controlled without energy dissipation.

Application of the Hall Effect

The above outline of theories shows the 'questions' of ether and gravity by no means settled, but it is my theory that a more or less complete and correct ether theory, based primarily on Tesla's theory, is possessed and used by the Secret Government, which developed and propagated Relativism to fill the void of the missing theory, in order to conceal and preserve ether physics for their exclusive use, while preventing the technology from damaging their interests under national security orders which prohibit us from using it. Otherwise, why would Tesla's 100-year-old theory still be classified? This concealment can be documented by a conspicuous lack of clarity and completeness in the use of such principles as the Hall effect to propel act only fluids, but solid masses, since it seems to apply to flying saucer propulsion. While I have found at least one group of patents for propulsion systems based on the Hall effect, the inventions inappropriately use the Hall effect only to pump air and electrons, not the ether, in a circuitous route only a few inches between electrodes. They missed the point entirely, which seemed to be the point of the patents, to discredit the Hall Effect as a viable application to propulsion.

With the Hall effect, the pulsing of electric input, rather than a steady D.C. current, increases the output.¹ This is consistent with the increase in electromagnetic reactance, at the fourth power of the increase in frequency. Tesla was therefore able to use his coil to produce "pseudo-electrostatic", D.C. pulses, which are not high frequency A.C., to produce his brush.

As determined by Nikola Tesla in his tests², at sufficiently high frequency and voltage, the ether ("Omni Matter") becomes "solid state", which means that it behaves similar to a solid mass under such circumstances. This obviously tended to confirm Faraday's theory of an "electric, elastic, solid ether" (solid to heat and light, but which allowed solid bodies to pass through). Tesla stressed the space between two electrified plates, in his original experiments, and also explored "unipolarity" of a single electrode or plate, as on a flying saucer surface, as it reacts with space and other matter. Tesla's tests of a saucer by 1915, tended to confirm his theory (along with the subsequent theories of J. J. Thomson and William Thomson), as it applied to electro-propulsion. The surface of a saucer draws in the tubes of force, which are dissolved in the conductor creating a propulsive force which is 10^{40} times stronger than the G-force constant, to provide the motive force. This is no more than a juxtaposition of the Hall effect as used in magneto-hydro-dynamic ("M.H.D.") generators and pumps.

Since the rigidified Omni Matter is ultra fine, it can pass into the attracting surface, carrying the tubes of force into the mass, where they are forced to dissolve by the high frequency 'blocking' current on the other end, leaving the Omni to pass through the body of the saucer and everything in it, and out the other side, with the only perceptible effects being acceleration of mass and the creation of momentum in the saucer and its contents. All physical bodies are 'saturated' with Omni Matter, and their atoms and molecules 'fly through' the Omni Matter like a flock of geese fly through the air. A better conception of what is happening with a flying saucer can be visualized by loosely analogizing it to a squid, which sucks water in one end and squirts it out the other like a jet,

¹Hall Effect Manual. Beckman Instruments, Inc., Helipot Division, Fullerton, California (1963).

²T.C. Martin (supra).

propelling the squid through the water, with the exception that the saucer experiences no internal turbulence or pressure. With saucer propulsion, the Omni Matter is stationary in respect to the universe, but dynamic in respect to the earth and matter of which the saucer is composed. The saucer moves through the rigidified, "meta-solid" ether permeating it, by pulling and pushing against it, by use of the Hall effect. By forcing the ether to move through the saucer, the saucer moves through it. This movement is obtained by inducing the tubes of electric and magnetic force to enter the saucer surface, then stripping them away to impart momentum to the conductive parts of the ship, as the Omni pass on through where they acquire new tubes after they exit the ship's posterior.

The ether carriers are exchanged through the saucer's electrified surface, behaving like a fluid mass capable of entering into the surface and passing through the saucer as it moves, leaving behind the momentum which is the product of the dissolved tubes of force, in satisfaction of the "equal and opposite" force rule. The internal contents of the saucer are not adversely affected, since it is "internally" accelerated at the same rate, in the same direction, instantly, by the dissolved tubes of force. The electromagnetic force pumps the ether which creates the tubes of force ("micro-helical tubes") through the mass of the saucer. These tubes are the source of inertia, momentum, polarity and precession, and can be turned on, off, or re-oriented instantaneously, to accelerate, decelerate, or change the saucer's direction instantaneously. The reaction between normal solid matter and the ether with its tubes, generates and gives rise to inertia/momentum, and gravitational effects. The effects of such sudden changes on objects and people inside the saucer are canceled with the re-creation of new effects inside the conductors, as the tubes of force are dissolved in them, which insulates the ship's contents from the effects of the tubes.

Normally, the individual ether carriers, possessing individual tubes of force terminating on them, create a resistance ("inertia") to changes in rate of acceleration or direction of a body. As the body is forced through space, the individual tubes of force are united, enter, and are dissolved in the moving body, tending to perpetuate its movement ("momentum") in its direction of travel, at 90 degrees to the tubes of force and the generated current, resisting changes to the state of motion. The micro-helices are of approximate atomic diameter, have pitch (angle of momentum) and angular velocity (at C, which means the saucer may only move at a maximum percent of the velocity of light). At a constant velocity, the micro-helices are without friction, according to the principle I call "The Law of Conservation of Perpetual Motion", which means that, with the micro-helices in parallel motion, the mass of the body reacts with the ether and ZPR in such a way as to counteract any internal friction. This is the reason that, at a constant velocity, when the micro-helices resist changes in pitch, momentum, or polarity—analogueous to inductance phenomena—there is no inertia (internal 'friction' caused by changes in orientation or pitch of the micro-helices). If the body encounters external force which acts to slow it down, the momentum of the micro-helices tends to conserve the motion, by 'screwing' each of the atoms in the 'micro-helical tubes' forward, along their polarized, parallel axes. The normal acceleration of a body through the ether creates the electromagnetic conditions originating the momentum, and which are synthesized by saucer electro-technology, in which both momentum/inertia is switched, and the saucer turned on a dime by reorienting the electromagnetic polarity and momentum.

Using the method discovered by Tesla, under special circumstances created by "p2", the potential of the ether to react as a continuous, electrically conductive, rigidified elastic fluid, is revealed, in respect to the negatively charged saucer surface and mass. The high frequency, high

voltage negative pulses, carried by the saucer surface in one direction, create a magnetic field across the surface at 90 degrees to the current, causing the mass of the saucer to accelerate in a direction normal to the surface (at 90 degrees to the current and magnetic field), according to the Hall effect, as the ether carriers and tubes of force are pumped through the criss-crossing electric and magnetic fields on the saucer surface, where the tubes of force are separated from the ether carriers and dissolved in the conductors, as the stripped ether carriers pass on through the saucer mass, and out the other side (as in an MHD pump), where they acquire new tubes of force. The total electromagnetic force, which is 10^{40} times stronger than the G force,¹ accelerates the ship at fantastic speed. All of the normal inertia/momenturn forces in space are manipulated by the saucer's powerful electromagnetic effects, by being forcibly "eaten up" on one end, with the saucer's movement being the "equal and opposite" effect..

There is a deceptive effect of the so-called gravity force, which makes it appear to 'penetrate' mass under normal conditions. This is demonstrated by holding one body above the ground, with a second body held above it. The G force appears to 'go through' the lower body, to pull the second, upper body down, with the force apparently not being blocked by the lower body. The force appears to be linear, penetrating, and undiminished and unblocked by other mass. These false appearances (what Einstein called "apparent effects"), are in reality a natural deception, resulting from the tendency to falsely assume that gravity is a force exerted at a distance through "empty space" between the bodies, by mysterious, unknown characteristics endemic to the bodies (in the absence of Ether Physics), when in fact, the force is exerted between the bodies and the ether existing in and between all bodies, due to the electrostatic ('microwave') inleractance created in the interpenetrating ether rigidified by these forces. As stated by Tesla², "...But place a gaseous (or liquid) column in an intense, rapidly alternating electrostatic field set the particles vibrating with enormous speeds, then the inertia resistance asserts itself. A body might move with more or less freedom through the vibrating mass, but as a whole it would be rigid."

Obviously, if the G force is so infernally weak in comparison to the electromagnetic force, it is scarce wonder that it could not really be such a "penetrating" one, where it would take an X-ray of several million volts to penetrate the two bodies. The force is exerted linearly between a smaller body and the earth, on the ether within each body, because the earth's electric field of influence has rigidified the ether, displaced it, and upset the equilibrium in the vicinity of the two bodies, which requires the smaller body's movement toward the center of the earth, as an equal and opposite reaction to the electrostatic forces. The movement of a smaller body in space above the earth, and within its field of influence, upsets the equilibrium of the ether, and pumps it upward through the smaller body, due to the electrostatic forces generated in the body and the earth by their movement through space. The tubes of force are unified and drawn into the smaller body and dissolved in it, thus accelerating the body downward, which is called "gravity", and erroneously thought to be a mysterious "attraction" between the two bodies.

The masses and movements of certain bodies in relative proximity, cause their electrostatic effects on the ether in their vicinity, to accelerate the bodies toward one another, almost as if they

¹The Electromagnetic Interaction (supra).

²Nikola Tesla, Experiments with Alternate Currents of High Potential and High Frequency (a lecture delivered before the Institution of Electrical Engineers, London, 1892)

were one body. Gravity and inertia/momentum involve electromagnetic polarization created by special unipolar electromagnetic (electrostatic microwave) radiation, resulting from disturbance of the ether and its ZPR transmissive characteristics. With every change in the axis of polarization of a body at rest or in motion, inertia/momentum must be overcome. Do these forces, once magnified by this technology, represent a danger similar to X-ray? The answer appears to be paradoxical, in that gravity is not really 'penetrating'¹ anything, but is only a reaction within and between atomic matter and the ether which does penetrate everything. While the high voltage emissions on the exterior of a saucer obviously represent a type of danger, the internal contents may be quite safe, due to adequate shielding and insulation. Through common sense, injury should be avoided.

The deceptive apparent effects have thwarted our attempts to understand that inertia, centrifugal force, and momentum are all created by the same interaction between atomic mass, ZPR and ether within or near a mass, as the mass moves (since all mass is in motion). On our planet, the electric field of influence dominates that of other smaller bodies in its proximity, including the moon, just as the sun's electric field dominates that of the planets in the solar system as a whole, etc. Being within earth's electric field means that the characteristics of the ether and ZPR have been polarized, displaced, rigidified to some degree, and otherwise altered and extended for some distance around it, so that on a macroscopic scale, bodies are made to behave as if they were a part of the earth's mass, or earth's mass system. The solar system is similar to a giant atom.

Under special 'synthetic' electromagnetic conditions, the characteristics of the medium (ether and ZPR) as the source of inertia/momentum, are altered, increased or canceled as one chooses, instantaneously. The normal requirement that such forces must be mechanically counteracted is circumvented by electromagnetically re-polarizing the forces within a body as it moves through the natural medium, in the direction desired. In order for a body to overcome the earth's gravity, an alteration of the same ether/ZPR reactions which are occurring within the mass of the earth, must be reversed within that body. The polarity of the momentum can be synthetically oriented in any desired direction, and increased or decreased as the body's electric field can be magnified (to mimic that of a much larger body), canceled (diminished to that of a non-existent body), or adjusted to whatever level and in whatever direction desired. In so doing, the effects of earth's electrostatic forces are overcome by forces created from within a relatively tiny body, due to the gravitational-to-electromagnetic force conversion constant which allows it to be much stronger.

Though gravity, like X-rays, appears to penetrate mass even more than X-rays, this is a misperception. Gravity causes no known damage to organic life as X-rays do, since the reactions between mass, ether, and ZPR are non-interactive in the frequencies of nuclear or molecular ionization of our organic beings, on our saucer, except on its surface, and create no reactions internally which could result in radioactive organic damage. These reactions are controlled by superficially applied electrostatic force, which affects the interpenetrating ether, without altering internal nuclear structures or organic life.

Microwaves do not ordinarily penetrate metallic surfaces. Ether and ZPR permeate all mass, operating in a different way. X-rays are damaging to cell life, while gravity is not, affecting mass in a non-radioactive way, by conditions created by the natural electromagnetic resonance of all gravitational bodies. The microwaves measured by Tesla, emanating from the earth, are generated by its movement through space, as a result of earth's mass and electrical content, cutting through lines of sun's magnetic field. The driving force behind earth's movement through space, is the giant current passing from the sun, through space, through the earth, and back to the sun, which

imparts momentum to the earth¹, by drawing tubes of force into the earth through the Aurora Borealis (earth's 'brush'), where they are dissolved. Norwegian Astrophysicist Hannes Alfvén recounted how Kristian Birkeland's measurements showed that "...magnetic fields generated by the aurora are so localized on the ground that they can only have been produced by nearly vertical currents—aligned along the magnetic field of the earth.." ² As Eric Lerner explained, Alfvén discovered that plasma clouds moving in the magnetic field of the sun, generate electric currents which flow to the sun, after which giant currents, with trillions of amps, flow out of the sun along solar magnetic field lines, into the earth's aurora, through the earth, back through the cloud, and back to the sun at its equator, and so forth, transferring momentum to the earth.

An oscillating electromagnetic dipole is always changing, and if designed properly, produces an externalized negative pulse radiating from a saucer, which, while affecting ether and ZPR both within and without the saucer, is not destructive to organic life. The key is 'positive' versus 'negative' radiation. Penetrating positive radiation (such as X-ray) reacts with nuclear mass within its frequency range, and transmutes it, while 'negative' radiation tends to react with the outer electronic structure of matter, and does not normally transmute nuclear mass, though the collisions of high energy electrons with nuclear mass can give rise to X-rays, by penetrating outer electron cloud barriers and entering into nuclear space, resulting in the excitation and relaxation of atoms, with the periodic emission of X-radiation.

The Precession Problem

Tesla's original flying saucer was apparently plagued by the problem of precession. It was for this reason that the Germans named it the "Kreisel Teller" ("Gyrating [precessing] Saucer"), which exhibited the behavior of a spinning top, especially when hovering, giving rise among speculators that the saucer's anti-gravity properties were created somehow by gyroscopic action. The mass of a spinning object in a state of uniform (angular) momentum, possesses uniform oscillations in axial and planar polarity. The axial polarity is uniformly precessing (rotating), while the radial polarity is also uniformly oscillating. Is the precessive force exerted parallel to the rotational axis, or perpendicular to it? Clearly, though we are more aware of the oscillation of the spin axis, the force of precession could just as well be exerted through the plane of rotation, as a twisting force directly related to the variations in frequency of toroidal micro-helices formed within a spinning body, due to the progressive difference in velocity between the mass near the center, and that along the outside. It could be due to an undulating wave motion within the ocean of ether saturating all bodies, which varies in frequency and angle according to the motions of individual bodies. It is related to the spinning of the tubes of force, unified and drawn from the ether into spinning bodies, and dissolved in them, and the rate at which they transfer momentum to the spinning bodies, similar to how earth's momentum is transferred from the currents in space.

The hydrogen atom resonates magnetically at 42.6 million times per second. This is its "NMR" (Nuclear Magnetic Resonant) frequency, the frequency at which the axial magnetic poles of the hydrogen atom precess, or oscillate. This oscillation is very fast as compared to the

¹Hannes Alfvén, Existence of Electromagnetic Hydrodynamic Waves, NATURE, vol. 150 [Oct. 3, 1942], pp. 405-6.

²Eric Lerner, The Big Bang Never Happened, Random House [1991].

precession of a top, yet the same rules govern both bodies. It would be impossible for a top to precess at 42.6 MHz., because its inertia and mass properties would cause it to disintegrate under ordinary circumstances, but the precession of its individual atoms at that frequency presents no such problem. Since a rotating body absorbs the tubes of force, translating them into momentum, perhaps the oscillations of the spin axis is determined by the rate at which momentum is transferred. Generally, the difference between the precessive frequencies of the hydrogen atom and the top, appears to relate to their comparative masses, which have a great difference in the momentum involved. By recreating the electromagnetic effects with an internal generator in a space ship, the ship will behave as if it were a single giant ion, having specific precessive effects peculiar to that body. If the electropulsive technology puts the atoms of the ship into a sort of "population inversion", it is possible that the precession of the individual atoms is transferred to the entire ship. The speculator looks for a "spinning body" when he observes precession, while the more intelligent thinker realizes that the precession of a large spinning body is more than likely due to a non-apparent electromagnetic effect having its origin in the reaction between the spinning atomic mass of the body, the unseen atomic matter and ZPR within the body, and the ether and tubes of force in the space in which it precesses. The phenomenon may not require a spinning body, but may be due to synthetically recreated electromagnetic reactions of a spinning body, on a non-spinning body. The precessive motion can be related to the cumulative electromagnetic effect of spinning electrons in a magnetic field, transferred as precession to the body.

The electropulsion used on a flying saucer may cause it to precess as if it were spinning or contained a spinning mass, just as electromagnetic conditions cause any spinning object to precess. The precession I witnessed may have been the result of one of Tesla's large alternators, being turned by a turbine. Since the rate and angle of precession was directly proportional to its rate of acceleration, consistent with a turbine turning the alternator faster to generate progressively more power. Whatever the cause of the precession, it seems endemic to and problematic with the propulsion system. If an internal spinning alternator were responsible for a saucer's precession, it would be difficult to isolate the rest of the ship from the effects of its gyroscopic action, unless it were placed on gimbals. As such, it could be used as the "master" gyrocompass, to be conveniently coupled with the Peiltochterkompass, to provide the navigational necessities of the saucer. If it were bolted rigidly to the airframe, the gyroscopic action would not permit the ship to be maneuvered in the manner observed, because it would resist being turned perpendicular to its rotational axis, and could only be turned around the plane of angular momentum. It would have been impossible for a saucer to turn the 90-degree vertical angles at high speed such as I observed in 1953, even using the so-called "Coanda effect", because the angular momentum of the gyroscope would have to be entirely canceled instantaneously, and reoriented and reactivated with each such turn, and such a possibility could only be effected electromagnetically, not gyroscopically.

In respect to aerodynamics, I was embarrassed for a fellow 'UFO' researcher, who claims to be a physicist, when I discovered in one of his books, that he believes that fast moving air from prop wash is "compressed" air with higher pressure than surrounding air. He apparently was unaware of the fact that aerodynamic lift is created by low pressure (faster moving) air, and was further confused by the fact that fast moving air has greater propulsive force (as an 'equal and opposite' thrust reaction due to an increase in its momentum, transferred to it by an aircraft), which is the main principle of rocket and jet propulsion. In applying this misconception to a little toy

styrofoam 'UFO' which uses a model engine and propeller in its center, to suck air across the annular ring-shaped airfoil around it, to create lift as well as downward thrust, he entirely misunderstood the means by which the toy stayed aloft. In this particular toy, the styrofoam ring to which the engine mounts are attached, is allowed to counter-rotate from the torque of the engine. This causes a certain amount of the air to be drawn along with the ring, due to molecular adhesion and viscosity. So in addition to the Bernoulli effect, the Magnus effect is added, to create further lift, by increasing the height and pressure drop in the burbles above the upper airfoil surface (I'm sorry, but it isn't easy to bullshit me on aerodynamics). The 'physicist' attempted to make the case that UFOs' work on the principle of "gyroscopic action". The problem was, both the engine and ring were rotating on the same plane, so any "anti-gravitational" force purportedly created by the outer mass, was counteracted by the counter-rotating engine. He had merely discarded aerodynamics completely, and by similar reasoning, he should have claimed that helicopters, airplanes, dirigibles, and gyrocopters are all "anti-gravity craft", and in point of fact, did just that. In my 1993 version of *Space Aliens...* (pg. 126), in passages written years before, I also made out a case for gyroscopic forces acting in "semi-defiance to gravity", but that argument is based on the generation of excess negative charges which are sufficient to alter the gravitational reaction, but still insufficient to create "anti-gravity" as compared to mere weight loss. It is also probable that many aircraft gain extra lift by accumulation of excess negative charges. Were the earth's magnetic field many times stronger than it is, a gyroscopic device might possibly generate sufficient negative charges to defy gravity completely, but this is not the case, and the 'physicist' was unable to cite a single principle—either of 'accepted' or 'dissident' physics—supporting his baseless theory, though he mentioned the research of others showing anomalous weight loss, most likely caused electrostatically. If he based his claims on their findings, and nothing more however, he wasn't entitled to call it "his discovery". Oh! His discovery of their discoveries and my book.

I knew that this 'physicist' had read my book (since he nastily asked me about something in it), but I have a nebulous suspicion bordering on certainty that he is a witting O.S.I. agent recruited from the KGB when the Soviet super-state fell apart, under orders to misinform the public, to counteract the potential effects of the ideas in my book, although he is possibly just another plagiaristic charlatan who wants to "steal my thunder", by 'taking a few ideas' and misusing them. He is frustrated by my preemption of material collected under Operation Paperclip in 1945, altered by the O.S.I., and recently disseminated in Europe concerning German flying saucers, which is depicted as La La Land misinformation typical of OSI liars, concocted to lure "new-age-prone" people away from the true theory. The dingy theories just don't hold water, and the gut feeling persists that they're the work of OSI misinformation squads. Besides, would the OSI release such information to a German group if it was true? Uhh, here you are, Hermann....the flying saucer secrets you've been asking for. Be sure and tell everyone.

In this book, I publish a valid, complete, "new" theory of gravity, for the first time (Tesla's 1893-94 Dynamic Theory of Gravity being never published that I know of), and the proof of the pudding is in the eating. The fact that this O.S.I. guy—supposedly educated as a "physicist" in the Soviet Bloc—has stuck his neck into a pseudo-intellectual noose, is proof that the CIA is in a panic. He not only failed to convince me that he 'discovered anti-gravity' or is a "dissident scientist" as he claims, but in his apparent ignorance, failed to 'one-up' me as he intended. If he were not C.I.A, he would still be a sucker for the CIA/OSI misinformation, spread through its German collaborators, ostensibly based on misinformation—altered and screened by the

O.S.I.—released through the "Hermann Goering Branch of the Knights Templars", in Bavaria. The fact that he failed to mention my book, though very familiar with it, indicated that he is possibly a former K.G.B. agent, now a witting O.S.I. agent, recruited by the CIA as the Soviet system collapsed. His claim to be a "dissident scientist" is apparently based on my writings to that effect, since I called myself that in my first edition. He parrots a slightly altered contradictory O.S.I. party line', dictated by the status quo of UFOlogy, including an esoteric, mystical propulsion system, and a purported 'anti-gravity propulsion system' based on gyroscopic action, which will never get off the ground. The Illuminati absolutely doesn't want anyone to get lift-off, and despite unfounded rumors, nobody has done so with gyros, or with any other ideas spread by the OSI. 'Founded' rumors hold that experimenters--several with PhDs in electrical engineering--are getting lift-off with models following my designs. The dummy "air conditioner vent" stuff based on the work of Victor Schauberger (as well as the alleged propulsion system for ancient East Indian Vimanas), looks like just so much farting in the wind. The "World Energy Grid" and 'harmonics' stuff of "Captain" Bruce Cathie (Ret.) of New Zealand also has nothing to do with saucer propulsion, since flying saucers fly independent to an "earth-grid", on internally generated power, reacting with the ether, tubes of force, and ZPR. Pseudo-"ancient", hocus pocus propulsion systems' are neither feasible nor explained, as usual, and are what one would expect from diploma-mill ancient history O.S.I. PhD.s, or 'retired' military aviators, attempting to impress us with military credentials. So, you wanna waste ten years trying to make it work, huh?

Any serious, intelligent physicists, interested in understanding the true nature of gravity and a unified field', would have to conceive of the interrelated movements of celestial bodies throughout the universe, as evidence of an integrated system of perpetual planetary and celestial motion, radiation, nuclear physics, and electric and magnetic currents, fields and effects. It is a circuitous, eternal process, in which 'energy' can be neither created nor destroyed, only changed in form. These forces continuously transmute in nature, whether or not humans use them to perform "work". Perpetual motion is the rule and not the exception. All energy and matter is conserved in changing forms, exchanging forces, effects, or matter, "using nothing up", and equaling zero. The Illuminati pseudo-scientists have labored so diligently for so long to talk us out of these obvious facts, and to convince us that we need Standard Oil of New York, etc., forever, and don't you forget it!

In the Big Lie Mass Psychological Control System, paranormal propaganda serves the purpose of stretching the public's credulity, so it will accept the Big Alien Lies—used to conceal flying saucer technology—on faith, not reason. In physics, Relativism serves the same integral false purpose, by stretching the credulity of physicists, so they will accept the Elastic Space-Time Continuum and Big Bang cosmography on faith, not reason. The Paranormal beliefs, combined with Relativism, completes the two essential tasks, by opening the way for acceptance of the alien lies, and opening the way for denial of a scientific explanation for flying saucer propulsion. By substituting Relativism for Ether Theory—which purports to solve problems it does not solve—establishment physics has no rational explanation for gravity, momentum, and flying saucer electric space propulsion.

SYNOPSIS OF FACTS

This book is related to the following list of little-known, officially suppressed, or publicly unknown facts:

1. An American citizen (naturalized), Nikola Tesla (an atheist and a capitalist), invented the flying saucer, before 1900, and reduced it to practice by 1915.

2. The American government helped the Nazis steal the invention from Tesla, through a secret 1936-38 project, at Los Alamos, New Mexico (then called the "p2" project), under the direction of the Baron Wernher von Braun, who was simultaneously collaborating in rocket research with Dr. Robert Goddard near Roswell funded by the American Rocket Society (The Smithsonian Institution and the Guggenheim Foundation).

3. The American government later helped Wernher von Braun, under the Nazi project (a forerunner of the Trilateral Commission) and CFR/Illuminati (who still retain control) remove the "KT-p2" Projekt ("KT" is for "Kreisel-Teller" [German, for "Gyrating Plate"], and "p2" is the electronic designation for Tesla's dipolar propulsion system) to Germany, in early 1938.

4. The Nazis, who developed and used the flying saucer during the war (called "Foo-Fighters" by us, "Fireballs", "Flying Saucers" [Fliegende Untertasse], and "Flying Turtles" by them), were unsuccessful in developing appropriate weapons for it until too late. They traded it to the U. S. government and corporations during the stalemate of 1945, in exchange for amnesty for numerous persons (including many war criminals), and for other concessions and guarantees.

5. The U.S. government (N.S.A., O.S.I.), on behalf of the Trilateral Commission/CFR, continues with and enforces a Nazi-originated "Big Lie" program, in which it perpetuates the hoax that flying saucers ("U.F.O.s") are: (a) Extraterrestrial in origin; (b) psychological phenomena ("collective consciousness archetypal images", ala C. G. Jung); © swamp gas; (d) "free-floating plasmas"; (e) piezo-electric effects; (f) ball-lightning; (g) other natural phenomena; (h) unknown life forms; (I) hallucinations; (j) non-existent; (k) hoaxes by attention-seekers; (l) the products of hysteria, insanity, etc., etc.

6. The German navy surrounded the U.S. with 24 U-boats, armed with (V-6?) I.C.B.M.S, having celestial guidance systems, and armed with neutron bomb warheads, trained on key American cities and centers, in a 1945 stalemate; German Admiral Karl Doenitz negotiated a secret truce and amnesty agreement with American authorities, under which he was required to order all 24 U-boats "...scuttled, with all hands on board...", under the agreement, pursuant to which Nazi skippers opened the hatches and the subs and all men on board went to the bottom Under Operation Paperclip, all Nazi scientific research materials, most of their important scientists, and the "KT-p2 Projekt" technology, were transferred to the U.S. and to the CFR corporations, thus attempting to insure that the Illuminati would retain control of the materials. Certain unusual security procedures were initiated to insure this, including the "sacrificing" of some major German scientists to the Soviets, to plant misinformation, and to insure that the hoax was successful.

7. During the war, German scientists bypassed development of the "atom bomb", and built and tested the neutron bomb. German field Marshall Erwin Rommel and the Afrika Korps were originally sent to North Africa to test the neutron bomb, as well as Tesla's "death ray" (which freezes whole armies); this technology was acquired by American corporations, held chiefly by

David Rockefeller, and was later sold in part back to the U.S. government and tested in the '60s, and the same technology was again sold to the U.S. government in the '70s and '80s, as "Star Wars" ("SDI" or "Strategic Defense Initiative") technology.

8. Over 15,000 German military, technical, intelligence, and support personnel were brought to America (mostly New Mexico—Manzano Base, Sandia Base, White Sands Missile Range, Alamogordo, Holloman A.F.B., Los Alamos, etc.) with the KT-p2 Project, in Sept., 1945, at which time, under Operation Paper Clip, Wernher von Braun became Director of Research, U.S. Army Ordnance, Ft. Bliss, Texas; he and his 116 top rocket and flying saucer scientists commenced rocket and flying saucer R & D. at White Sands Missile Range, and Alamogordo.

9. Howard Hughes' "Glomar Explorer" was built to retrieve the 24 scuttled German U-Boats, before terrorists or unfriendly governments found and retrieved the subs, missiles, bombs, and related technology. The WW II German "Electro-U-boats" were powered by a type of magnetic-electric generator (invented by an American named Dort, of Virginia), based on a Tesla oscillator, which was superior to nuclear power. Further details about the German 'ship', the Graf Zeppelin, are included in this book; Adolf and Eva (Braun) Hitler were daringly rescued from the Berlin Fuehrerbunker by a flying saucer, flown by test pilot Hanna Reitsch and long distance flight expert Hans Ulrich Rudel. The Hitlers were later protected by the secret amnesty agreement, for the remainder of their lives under protection of the N.A.T.O. alliance, in Kassel, Germany, ironically the home of an international monument to the Holocaust. The Hitlers even visited Hemisfair, the World's fair at San Antonio, Texas, in 1967, on the invitation of L.B.J.

10. Part of the original deceit was under way at Wright-Patterson A.F.B, Ohio, even before the German surrender; Edgar Cayce was already employed as a technical writer, to revise, adapt, and resume the propaganda work pioneered by Hans Hoerbiger, Hitler's personal guru and astrologer, the official "father of parapsychology", and designer of the Nazi "Big Lie" system, in which the public's credibility 'window' is wallowed into a giant hole, allowing the indiscriminate acceptance of faceless authority and whatever the government says; the U.S. government even hired an Ohio naval law professor (and genius) to revise and popularize "Astara" ("Ostara" to Hitler), the Nazi religion based on the Bonpas (Tibetan black magic) religion, imported from Tibet to Germany by general Karl Haushofer, an ordained Bonpas priest, as the basis for the S.S., financed and set up on instructions of the British-American CFR, in 1919; the S.S. Bonpas worshipped "Kali Ma" ("Bloody Mother"). This cult founded the ancient Thugee cult of India, and was the basis for the Society of Assassins; the concepts of this weird religion related to the mass extermination of people, through many means, including assassination, extermination, and war, as the basis for all 20th century totalitarian movements.

11. Most forms of mass communication are primarily controlled or produced by the Illuminati, through the secret agencies of our government, to brainwash the public, in the most monumental hoax in history, to socio-economically control the world, and to perpetuate lies designed to obscure the flying saucer's man-made origin and use (as well as to steal and conceal or monolithically control all other advanced technology); the government hires consultants, contract script writers, and teams of PhD.s, to create and disseminate Big Lie propaganda, in countless pulp magazines and newspapers, and finances and produces books and movies of the Close Encounters of the Third Kind ilk, to perpetuate the "extraterrestrial" myth; the government controls and manipulates the press, hires lecturers, and organizes and funds UFO groups; it stages "abductions", using actors, drugs, and sets; Operation Blue Book was set up at

Wright-Patterson A.F.B., to retrieve leaked information and plug leaks, disseminate misinformation, falsely represent "expert, objective, scientific opinion", and to ferret out 'problem people'; mystical organizations (such as A.R.E.—Association for Research and Enlightenment—part of the Edgar Cayce Foundation, of Virginia Beach, Virginia [conveniently close to CIA headquarters])—are created for the same purposes, and set the stage for the type of mass psychological control of the public required for totalitarian control by mystical cults, such as "Communism", "Naziism", "Synergy", or "Parapsychology" cults.

12. Flying saucers operate on basic, simple, sound (but very carefully obscured) scientific electrical and physical principles, known for over 100 years; Nikola Tesla's discovery has been concealed for over 60 years, and all public sources were thoroughly scoured by the F.B.I, in 1942; the flying saucer uses the electromagnetic interaction, which is 10^{40} times greater than the gravitational interaction, to move huge saucers at fantastic speeds, in apparent defiance to the laws of physics as currently taught, with almost no net energy consumption; they can be powered by unlimited electrical energy extracted from ordinary atmospheric air, based on Tesla's ca. 1900 discoveries; (NOTE: this book tells how to build your own flying saucer.)

13. "E.S.P." and "psychic phenomena" movements (based on Hans Hoerbiger's original Nazi "parapsychology") are orchestrated and promoted by the N.S.A., as part of the continuation of the original Nazi Big Lie program, to dupe and brainwash the public, and to induce unquestioned faith rather than reason; this clandestine manipulation by the government is an unconstitutional abridgement of the U.S. Constitutional First Amendment prohibition against the government's recognition or promotion of an "establishment of religion" (i.e., generally, a mystical belief system based on faith rather than reason).

14. As an underlying cause of the "Holocaust", a proposal was made by the U.S. Government to the Treaty of Versailles Committee, in 1919. In a document known as "Morgenthau's Pastoral Policy", signed by president Woodrow Wilson (drafted by his Illuminati advisor, Hans Morgenthau, Sr.) and presented at Versailles. Under it, the U.S. attempted to make, as one of the provisions of the German surrender, the extermination of all Germans, as an "inherently warlike race", and the "reduction of Germany to a pasture land". The document, examined by me in 1968, was among the papers of former president Lyndon Baines Johnson, now kept in the Sid W. Richardson Research Center, at U.T., Austin, named for my third cousin.

15. The "cattle mutilations" phenomenon is an ongoing program of the CIA's Special Operations Division. 'Biological samples' are removed by specially trained flying saucer crews, from thousands of cattle grazing in remote areas, for analysis, to measure radiation-caused auto-immune-deficiency and reproductive sterilization effects, after the cattle have been subjected to irradiation by "Death Ray" devices under development since the '60s. Since 1979, the saucers have bombarded members of the public, under the MK-NAOMI Program of the CIA, for purposes of "population control" (i.e., extermination). Government scientists use special surgical devices, standard blood coagulants, and cryogenic technology, enhanced by microwave equipment, to remove the cattle blood (and ears, lips, tongues, mammary glands, genitalia, anuses, etc.); afterward, the carcasses are returned and air-dropped from flying saucers, back into their original pastures; the mysterious circumstances are then misconstrued by government-spread rumors of "extraterrestrials", attributed to "Satanist cults" or other cults created by the government, or "coyotes and other natural predators", etc. (Of course, MAN is a "natural predator".) (For more on

this, see Chapter HI: I Meet a Government MLB. in Santa Fe: Hollywood on the Take, and Chapter IV: Sightings)

16. The Antarctic "Ozone Hole", which U.S. government scientists pretend to be at a loss to explain—yet blaming it on 'aerosol sprays'—is probably the by-product of three nuclear missiles, armed with hydrogen bomb warheads, which were launched from the Antarctic by the U.S. military, on Aug. 27, Aug. 30, and Sept 9, 1957. The warheads were detonated at a 300-mile altitude, to create a reflective spherical layer of ionic particles surrounding the earth, to bounce radar impulses between the layer and the earth. The Strategic Air Command's global "backscatter" radar system, operated from the North American Air Defense (NORAD) command center deep beneath the earth at Cheyenne Mountain, Colorado, thus became operational in 1957, in time to verify that the Russians fired the rocket which launched Sputnik.

17. The N.S.A. protracts a false "national security" veil, to continue concealment of flying saucer technology, creating false fears of 'rampant anarchy, 'chaos', and other exaggerations and ruses, before N.S.A. committees, to justify continued secrecy, and to continue to deny public access to or to declassify the technology. (If society isn't ready for it, how can THEY be?)

18. The true scientific principles of gravity have been misrepresented, confused, and concealed by "Big Brother", even in school books read by our children, just to conceal flying saucer technology, to protect the energy cartels and the mixed-economy socialist political power structure from losing its illegitimate parasitic grip on us.

19. In 1893-94, Nikola Tesla, a patriotic naturalized U.S. citizen, of Serbo-Croatian birth, discovered a new theory of energy and gravity, called the Dynamic Theory of Gravity, which represented a unified field theory. Tesla's energy equation, " $C = E/R$ ", and Tesla's application to the Swiss Patent Office, for his flying saucer patent, was made while Albert Einstein was a second class patent clerk there. Einstein's work was an Illuminati conspiracy to obliterate Tesla's discoveries, so the Illuminati could control flying saucers and create our energy slavery.

20. The government's policy of looting and suppressing ideas from independent scientists, inventors, and thinkers, on behalf of the Trilateral Commission, is related to this process, involving (1) stealing ideas from creative individuals; (2) destroying those individuals' credibilities, to conceal the sources and technology; (3) ruining the lives of those individuals (even murdering them if necessary), and denying compensation or credit; (4) exercising the option to suppress the ideas under "national security" laws", or giving the discoveries to their corporate crook partners for exploitation; and (5) abusing and misusing the judicial system to carry out and enforce this illegitimate, criminal process.

21. I am either correct in what I say, or am entitled to a Nobel Prize for new discoveries in gravitational theory and nuclear physics. The former is most certainly true. Since Russia in fact acquired the services of the top Nazi flying saucer scientists, and the top rocket scientists, from the Peenemunde operation, in 1945, there is a strong possibility that the Russians were privy to these secrets.

PART ONE: THE TECHNOLOGY

CHAPTER I: STAGE I SECRET GRAVITY PHYSICS

"Stage I Secret Gravity Physics" includes an attempt to explain gravity as an electrostatic phenomenon.. Though incorrect, this argument is included and compared with the material in the Introduction ("XI: Occult Ether Physics"), and other material, to give it as fair an argument as it deserves. Ether physics is "it", There is not 'another system' which is powered by electrostatics, or Felix Schauburger's alleged boundary layer or other vague, undefined, "new age Austrian" method. Though other flying craft may be 'saucer-shaped', if they are not electrically powered, they are no more "flying saucers", than an oxcart shaped exactly like an automobile is a "car". The "Adamski-type" ships were complete fabrications, photographs of a chicken feeder. Adamski was on the CIA payroll, and his allegations were misinformation. In addition, there are many ways to create hoaxes. For example, it is easy to suspend a model from a balloon, by means of a fine nylon fishing line, with camera out of focus, and produce a convincing photograph. Get real.

Reality is unmistakable in certain cases. I knew from my observations in 1953, that a secret theory of gravity physics is involved in flying saucer technology. Today, over forty-five years later, the underlying cause of gravity is still (supposed to be) a mystery. People continue in the Relativist Rut, blabbering on about Einstein, but Einstein never explained gravity. Truth, like creativity, requires courage. Scientific cowards continue to yield to the Trilateralist sham. Since around 1950, textbook writers have followed secret government orders, helping us 'forget' some (now) little-known facts once taught along with Newton's law of accelerating bodies. Fascist-state revisionists concealed the scientific truth about gravity as a "national security secret". In 1942, the F.B.I, sequestered all known information relating to a scientific understanding of gravity, electrical control of gravity, or 'free energy', as it might pertain to flying saucer technology. Accordingly, the same CFR and Illuminati which controlled Wernher von Braun and the Nazis, in the 1936-38 Los Alamos "p2"project, controlled our F.B.I. as well. For this reason, I have renamed J. Edgar Hoover, "J. Edgar Himmler, the American Fascist in a Red Dress".

To conceal "flying saucer secrets", they rewrote theoretical physics, obliterating the greatest moments in mankind's scientific history. Perhaps when our people are reduced to ignorant, scientifically-deprived yokels, we will have "national security", and only the NSA., the CFR, the Trilateral Commission, the Bilderbergers and the Illuminati (all one and the same) will possess true scientific knowledge. What the Rosicrucians/Illuminati refer to as the "wisdom of the ages", is actually a collection of stolen and concealed scientific—not "mystical"—secrets! Such knowledge is discovered by individual geniuses, deluded into thinking they are doing mankind a favor, but instead unwittingly doing research for the Trilateral Commission/Illuminati rats, who will steal and hide such "treasures of posterity", and use them to enslave mankind

After all, the rats said, since a 'healthy petroleum industry' is essential to "national defense", protecting Big Oil at the expense of scientific, economic, and social freedom and progress, is in the "national security interest". Since society is "not ready for the flying saucer" - they decided without our consent—such secrecy was "sound public policy"; after all, how could Gulf Oil continue to produce and sell gasoline and diesel at a 'fair' profit, if one could fly a zillion miles on a gallon? With such inventions as the flying saucer at the public's disposal, the economy would be wrecked,

they said (at least for the Trilateral Commission). Meanwhile, our government helped the fascists take firmer control of the system, in the interest of "national security".

PHONY RESEARCH AND SCIENTIFIC ALZHEIMERS

Numerous centers throughout the world conduct "gravity research", to 'prove' Newton's laws. The only parts of these old laws which have been brought into question, deal only with the first few inches of a falling body's acceleration. The remainder of the tests are false, deceptive, and unscientific, intended to dispel widespread suspicion by lay people, to reassure the lazy scientists who accept them, and to heap ridicule upon doubters. Without accurate and honest tests, over at least 1,000' of vertical drop, the results are worthless. Yet what independent scientists have the personal finances or resources to conduct these tests accurately on their own? Most people accept the theories of the "experts", failing to realize they are government-paid, Trilateralists/Illuminati national security" yeggs. "Question everything", the ancient Greeks wisely advised.

I predict that proper tests will eventually disprove Newton's laws in a big way. Such tests would require a vertical, non-metallic, non-electrically-conductive tube, extending up at least 1,000' from the earth's surface, which could be evacuated. A weight carrying a precision movie camera with a digital clock read-out, would photograph calibrations on the sides of the tube, as it was dropped. Its rate of acceleration would be accurately recorded. When the weight reached approximately 120 mp.h., no further acceleration should occur. At the accepted rate of acceleration (32'/sec./sec.), the 120 mp.h. velocity should be reached at approximately 696 feet. However, if I am correct, this could take either more or less distance/time, depending on the reaction.

Nikola Tesla's Dynamic Theory of Gravity provided a scientific basis for explaining Newton's "laws" of gravity, which attempted to explain with some degree of mathematical certainty, the physical measurements, and offered no cause. Even this is questionable.

The erroneous concept of "anti-gravity" cannot explain flying saucer propulsion. Insufficient to merely "overcome" gravity, or "reverse" it, propelling a ship with astounding results and directional controls is much more. The fictitious moon ship of H. G. Welles' Dr. Cavour was based on a "blocking" theory, in which 'doors' were painted with "Cavourite", which blocked gravity. This chapter includes my examination of an electrostatic theory of gravity, and attempts to explain flying saucer propulsion in the manner demonstrated by observed flying saucers.

Hydrogen has the highest charge-to-mass ratio of any element. Accordingly, it is the lightest element, even though its nuclear proton and orbital electron are identical to those of lead. The masses of the remaining elements are determined according to their respective mass units and densities, and charge-to-mass ratios, which are correlative to their relative gravitational, electric, and electromagnetic interactions.

I consider electrons as already having "negative gravity" (or "anti-gravity"), even though they have mass, because they will normally tend to gravitate upward from the earth, like a light gas, due to their high charge-to-mass ratio and low mass density. This is more consistent with ether theory than with Relativism. Cosmic radiation and lightning storms bring electrons down to the earth, which is generally an electro-positive mass, upon the surface of which a continuous negative charge is maintained by lightning, though the electrons tend to 'leak' and migrate back upward. Accordingly, the ionosphere is charged at least 176 million volts positive in respect to the earth,

creating a vertical electric field, which gradiates from sea level, around 150 volts per meter upward, from negative to positive. This electric field is reversed and multiplied around ten times under storm clouds, rendering the earth's surface relatively positive under the storm clouds, since the higher negative charges of the clouds repel the earth's negative 'like'-charges.

This vertical electric field might be erroneously conceived as the origin of gravity, but there are many gravitational planets which have no ionosphere, while all atomic mass possesses electrostatic charges which are in motion with the masses, representing currents (H. A. Rowland's experiment), a fact used by Tesla in support of his Dynamic Theory of Gravity.

Gravity is apparently a secondary product resulting from an imbalance of other, primary forces. No separate basis has been found, though an electrostatic imbalance is evidenced in atomic matter. The Dutch physicist, Hendrik Antoon Lorentz (1833-1928), in measuring the relative magnitude of the single negative ("moving" or "orbital") electron charge, and the positive ("stationary" or "nuclear") proton charge in the hydrogen atom, actually claimed the two to be slightly unequal, with the proton possessing an excess positive charge, slightly greater than the allegedly 'equal and opposite' negative electron charge. This information has been conveniently disregarded, since, by implication, it contradicts the Relativist Theory, since unequal charges could disqualify the entire theory, and support Tesla's Dynamic Theory of Gravity. Lorentz further postulated that this excess positive charge is responsible for the weak force of gravity, and that, by increasing the negative (moving) charges, the gravity of an atom's stationary nuclear positive mass would be entirely "canceled". Even so, how would this explain electropulsion? It wouldn't Lorentz calculated the electromagnetic forces encountered by a body, within an electric and magnetic field, according to the equations of Sir George Clerk Maxwell. This force, called a "Lorentz Force", is so much more powerful than the force of gravity, that it is difficult to conceive. Nonetheless, it is only part of the picture, since it purported to represent only a comparison between static electrical and gravitational attractive forces, rather than the net dynamic "interaction". After all, one has to bear in mind that, in addition to Werner Heisenberg's so-called "Uncertainty Principle", there is the problem of considering the fact that, in all attempts to measure anything on earth, all the measuring instruments, the observer, and all charges are in motion, at over 70,000 mph through space, which means that everything contains "currents".

INERTIA AND ELECTROMAGNETISM

Since, according to Lorentz's hypothesis, gravity is the result of an imbalance in electrostatic charge/content, this imbalance should also explain Newton's laws, except there was no provision for the dynamism of the universe in it. Since Nikola Tesla knew Lorentz, it is also possible they discussed these views. Tesla said that electrostatic force is the most important force for us to study. Although his gravity discoveries were complete over 100 years ago, the Illuminati stole ten away, and smugly keeps them from us today, while hiding, or misrepresenting essential parts of gravity and ether theory and experimental results.

Excess positive charges, or parts thereof in a body, induce negative electrostatic reactance when moving through space permeated by electric and magnetic fields. Since all mass is in motion, and all space is permeated by electric and magnetic fields, this inducement applies to all bodies and all space. The earth induces negative electrostatic reactance as it moves through space. Naturally, this inducement also applies to all bodies within the dynamic electric field of earth, in

which enormous, rapidly varying electrostatic forces exist. This inducement continually changes the electromagnetic characteristics of the bodies and the space, according to their relative movements, and redistributes the conglomeration of changes. Accordingly, with a redistribution (or "displacement") movement, away from or toward the equilibrium position, an equal and opposite force tending to counteract it, is produced in the direction from which the negative electrostatic forces of the earth emanate, which is called "gravity". This is part of Tesla's Dynamic Theory of Gravity, which requires an understanding of the ether and its effects.

Inertia is the resistance within a body to changes in its state of motion. Momentum is the same thing, since all mass is already in motion, but the cause of this resistance to change requires an ether theory which includes the tubes of force. Inertia/Momentum is observed in the dynamic rotor of an electric generator, in which the momentum of the rotor is imparted, via electric current (tubes of force), to the rotor of an electric motor run by that current. In other words, as the rotor is placed into motion, it absorbs electric tubes of force, which travel through the circuits to the motor, which absorbs and dissolves the tubes, imparting momentum to it. Although the laws of inertia are incorrectly said not to apply to the laws of electromagnetism, that is a lie. Where the electromagnetic interaction is 10^{40} times stronger than the gravitational interaction, force gathered in a gravitational interaction—momentum—such as by hydraulically turned dynamos, may be converted into much stronger electropulsive force! (In this respect, I refer you to the Introduction; V: A Comparison of Gravitational and Electrical Force, as Applied to Flying Saucer Propulsion.) This little trick of nature yields so much free energy that the Illuminati have been masturbating over it for over half a century. It allows for much more powerful electromagnetic energy to be concentrated and stored in much weaker inertial form, until converted and magnified into relatively super-strong electropulsive form.

If inertia is the result of a body's resistance to changes in the strong electromagnetic patterns (the pitch, frequency, and momentum of its ether micro-helices) existing as a result of its particular state of rest or motion, within a particular electrostatic ether environment, then the synthetic conditions of an electric generator's rotor field coils are only an unnaturally altered state of the conditions which were already there. I am reminded of the account as to how Tesla discovered the rotating electromagnetic field, in a flash of creative intuition, while on a walk with a friend named Tageti in Buda-Pest, over 100 years ago, and quoting a line from Goethe.

Existing patterns of forces acting on a body become uniform whenever there is no change in its state of motion, and the body encounters no force. Only when the body accelerates, decelerates, or changes directions, or encounters certain external bodies or electric or magnetic forces, do the existing patterns of force resist the change. This is consistent with the theory of the tubes of force. It is obvious that this phenomenon is electromagnetic. Albert Einstein's hypothesis that a mechanism having weights which oscillated over time, as a gravitational analogy to the oscillating electric and magnetic fields in inductance, would generate "gravity waves", as the gravitational equivalence of electromagnetic waves, was obviously wrong, else someone would have easily proved it. Since that hypothesis has never been a secret, it is additionally wrong. Just exactly how Einstein thought such 'waves' were supposed to be responsible for the alleged "attractive force", even if they could be generated that way, remains unclear.

The reason we know that inertia/momentum is an electromagnetic phenomenon, is because it occurs only during the acceleration, deceleration, or directional changes which are essential to inductance principles, and because we can find no other reason. Since no inductance occurs unless

electric or magnetic fields change, or unless a body moving within them changes, causing inversely rising, collapsing, and reversing electromagnetic fields, there is no essential difference between electromagnetic and gravitational, inertial/momentum forces, which cannot be explained using electromagnetic theory, integrated with a valid and consistent theory of ether physics. The propulsive force also appears on the correct axis, as predicted by the Hall Effect.

We know that magnetic lines of force exist, and can chart them with paper and iron filings. These lines represent variations in magnetic flux densities, along and across flow lines. Whenever a conductor or body cuts through them, electric current results in the conductor or body. An electric current creates a magnetic field around itself and the conductor or body through which it flows, at right angles to itself, according to the "right hand rule". The variations between the magnetic field lines represent the necessary changes required to generate the current within the conductor cutting through them, and therefore even a "D.C." generator creates its current by an "alternating" (high-frequency) inductance phenomenon.

MOMENTUM AND INDUCTANCE

Since a spinning object cuts through lines of a magnetic field which can permeate it, the earth thereby generates an electric current, which continues to build up at right angles to its magnetic field, until sufficient to cancel the magnetic field. This comports with the Hall Effect. If the current is drained off, the magnetic field is increased, and vice-versa. If a spinning object creates an oscillating current, it therefore constitutes an electromagnetic dipole, which multiplies the electromagnetic energy radiated at the fourth power of its frequency. As Tesla said, every physical entity has a natural set of electromagnetic resonant frequency characteristics. It has been suggested that gyroscopes actually respond to electromagnetic transmitter/receiver effects, beyond our solar system. As the basis for the celestial guidance system invented and tested by Tesla in 1917, and developed further by the Germans during WW II, they were not used by us until twenty years later. The electric field of a spinning body, at a particular rpm, within earth's weak magnetic field, should generate increased negative charges sufficient to partially cancel its own gravity, by causing a partial reversal of the displacement of its charges, to lessen their down force, as the ether passes through. Since it rotates about its center, the greatest angular velocity is along its outer circumference. Once its surface charges begin to move, the magnetic field is progressively blocked, as in a Faraday cage. Because earth's magnetic field is so weak, a spinning body will not develop enough upward electromagnetic thrust to become weightless, but delivers its entire gravity on its spinning point, even when turned completely sideways, as with a gyroscope, which behaves in "semi-defiance" to gravity. The stabilizing properties of a gyroscope, which behaves as if held by something in space, proves the existence of the ether and tubes of force.

I observed that precession is common to falling objects, even though they are not spinning, which becomes especially pronounced after they have fallen for around 700 feet. This can be seen in movies of falling bombs. Though an object falling at 120 m.p.h. may be virtually weightless, it still has momentum/inertia, and the force delivered when it strikes the ground is electromagnetic momentum built up over time. A flying saucer's electromagnetic momentum is not bound by the law of acceleration of falling bodies, determined by the time required for a falling object, accelerated by the force of gravity, to absorb a certain quantum of tubes of force, but may be greatly accelerated by the high voltage current, and multiplied. Falling objects are penetrated by

ALIENS56

ether carriers, which bring along the micro-helical tubes of force, which during acceleration have progressively increasing pitch, before dissolving, transferring momentum to the mass.

All bodies are both gravitationally and electromagnetically affected by the principles of inertia, momentum, polarity, and precession, as explored in the Introduction. Their movement, as flying machines, may be caused according to the Hall Effect the reactions of which are of such magnitude that they can only be surpassed by nuclear fission or fusion reactions. Nikola Tesla built his flying saucers around 1915, using his tuned, resonant air-core coils. 62 years ago, there was a secret German flying saucer project at Los Alamos, using technology stolen from Tesla, called "p2", the existence of which has been carefully concealed.

Baron Wernher von Braun was in charge of that project. He dated several women in the Santa Fe area, in 1936-38, and those women described him as a romantic and gregarious man. He moved rather freely from Germany, to here, then back to there, to run Germany's top secret "rocket" center at Peenemunde, then easily glided once again back to Ft. Bliss, Texas, in 1945, all with the facility of a gazelle leaping a small creek. Von Braun was not an inventor, but more of a "pusher" of projects...a "politician with a rocket". He has been depicted as a "dreamer", who only wanted to "go to the moon"...to travel "...beyond the stars". Now that we know of his control over the "p2" project, on behalf of the Illuminati, a secret society to which the major political players—Hitler, Einstein, Von Braun, Himmler, Lenin, Trotsky, David Rockefeller, to name only a very few—all belonged, the almost incredible phenomenon of von Braun's international cha-cha is more fully understood. And what of the false story that there was "...nothing at Los Alamos but a boy's camp" before the war? It is simply not possible that those responsible for that story could be so ignorant, and the "Los Alamos Story" is just one more chapter in the Book of the Big Lie, intended to magnify the importance of the huge government expenditures there, by laying claim to many things which were developed first elsewhere, by other people. Even the "p2" project was second-hand, having been stolen from Tesla.

WEIGHTLESSNESS, "p2", AND THE TUBES OF FORCE

It is my belief that an important fact has been ostensibly omitted from what is taught today...that a falling body will cease to accelerate when it reaches a velocity of about 120 m.p.h....at which it naturally maintains or tends to maintain a constant velocity. Has this been secreted away by the Illuminati, because it presupposes other important facts, which naturally occur once the first fact is known? If so, it represents additional proof of the existence of an interceding 'substance'—the ether—and suggests the accumulation of something at a predetermined rate which has reached its maximum under the natural forces present. If the reaction due to the gravitational constant G ceases to accelerate a body at the 120 mph velocity, it could be because of a time-related "equal and opposite reaction" to the force with which it is actuated to move downward, evidenced by the counter-buildup of momentum, sufficient to cancel the acceleration due to the gravitational force G. Does this buildup cancel the G-force, proportionately with time, as the body finally becomes weightless, with its entire gravity cancelled?

Could it be for this reason that one physically, momentarily, senses complete weightlessness, when riding in an airplane which is taking off, at the instant that it passes through the 120 mph velocity? Most people probably think the sensation is when the plane leaves the ground, because so many planes leave the ground at about the same time, but the sensation of physical

weightlessness is quite different than just becoming airborne, and can be felt in the inner ear, causing a special sensation in the stomach. It is also possible that the principle of aerodynamic lift is supplemented by the tubes of force as stated in the Introduction.

As atmospheric air resistance slows down a falling body, the gravitational constant again comes into play, so as to accelerate it once again to the constant velocity, and so forth, thus maintaining the constant velocity, at which the equal and opposite positive-mass G-force, and the anti-gravity, electropulsive neutralizing force, are in equilibrium, with the precession angle at its maximum, and precession frequency at its minimum.

Michael Faraday's experiments showed that an excess negative charge will always appear on the surface of an enclosed, hollow vessel. You place a charge inside, and it will always appear on the outside. This mystery is a convenient tool for flying saucer technology, because we don't want those charges jumping around inside our cockpit, all over us, but want them outside, where they can do their work.

All bodies are essentially composed of entities which represent "electrical content" (protons, electrons, neutrons). The presence of these charges in a dynamic mass, allows it to generate or attract its own electrons, to create them from Omni Matter, or to emit them, and to encounter its own gravitational reactions, according to its relative movement, within the magnetic and electric fields of its environment.

This is probably what Nikola Tesla had in mind in his Dynamic Theory of Gravity, The fact that the government has it, and no copies of it are available to the public, should indicate the importance of this over 100-year-old theory, except most scientists have never even heard of the theory. We already know that the same Trilateral/Illuminati symbol was used in the original Nazi-run "p2" Los Alamos project, and in Chapter II, I relate how it appeared on the 1950's I.G.S. resonator implantations. It has been reported in several forms on UFOs.

According to what we know about the difference between the gravitational, electrical, and electromagnetic interactions, if there is a tiny excess positive charge on the proton--so small that its detection has been concealed from ordinary gullible 'physicists'—such a charge could hypothetically be the origin of the weak "gravitational interaction". Suppose the gravitational force is equal to the electrical force created by the hypothetical excess positive charge of the hydrogen proton, in terms of accounting for its "gravity", which is the least for all known elements. For the same reasons, all the elements would be very close to being weightless, An atom of even one of the heavier elements, lead, may require the addition of less than a single electron, to gravitationally/electrically cancel all of its mass units, and to give it the same charge-to-mass ratio as hydrogen. In order for us to appreciate the power electrons exert over protons and neutrons, it should be emphasized that the mass of a proton is around 1,837 times that of an electron, (the neutron having a slightly higher ratio). While it is said that the neutron is electrically neutral, because it is composed of a proton and a 'tightly bound electron', this neutrality only applies to electrical conductivity, and has not been shown to relate to electro-gravitation. The neutron's tightly bound electron already cancels most of its positive charge, but the cumulative total of all the tiny excess positive charges—if the Lorentz hypothesis is correct—of the 82 protons and 125 other neutrons of the lead atom, are still unaccounted for. Under these circumstances, the vast differences between electromagnetic and gravitational interactions favors "gravity". Since it would only be necessary to add whatever negative charge required to equal the totality of all those tiny excessive positive charges, in order to completely cancel the gravity of the lead atom, it would be necessary

ALIENS58

to add less than a single complete electron! Otherwise, the lead atom would already possess another electron. The first thing that an atom "does" when its nuclear mass develops an (electrical) "need" for another electron, is to acquire a new one in its outer orbit.

All atoms, molecules, or compounds, composing the matter on or around our earth, are predominantly electro-positive (although some of them are considered electro-negative in relation to hydrogen, sometimes by as much as perhaps six volts, but this is only in terms of "free electrons", in non-ionized states). The charge-to-mass ratios of all elements are positive in nature, because in all cases, even hydrogen, there is excess positive mass in their nuclei.

The high voltage charges on a saucer's front or top, easily "penetrate" electron cloud barriers, and should exhibit an electrical attractive force toward external positive matter, which according to Lorentz, is 2.2×10^{39} times stronger than the gravitational attractive force, but this is not true, and does not work "at a distance". This huge force, which according to the Newtonians, acts over a greater distance, conflicts with the Relativists, who don't believe there is a force at a distance, which is something I agree with, for different reasons. The "electromagnetic interaction", for reasons unexplained, is less than this, or 10^{40} times the gravitational "interactive" force G. If the Relativists don't believe in force at a distance, why do they keep referring to the "attractive" force?

AN ALTERNATIVE TO THE LORENTZ TRANSFORMATION

It has been incorrectly assumed that the Michelson-Morley Experiments disproved the existence of an ether, based on a failure to observe a "shift" (the "red-shift") on the fringes of two light beams placed at 90 degrees, perpendicular to the earth, at equidistant positions from their point of intersection. Since ether theory asserted the ether as the medium which conducts light through space, and since no shift was observed, these results were misinterpreted to mean that there is no ether. This experiment was based on Lorentz' erroneous concept of a "quiescent, stationery ether", which held that there is an ether 'wind' which is everywhere the same, and that Maxwell's deficient calculation of C was a constant, but which in fact failed to provide two required constants of integration for time (one for each of its two differential equations), which included no definition of Maxwell's coordinate system's position and velocity (as a vector sum).

The false assumptions which arose from this failure by Maxwell resulted in the Lorentz' equation, called the Lorentz Transformation, which had built into it, the elastic space/time frame which attempted to supply Maxwell's lack of definition, and to explain the red shift observed near planets in space. It was this elastic space-time frame in the Lorentz Transformation which was adopted by Einstein in his Relativity theory, initiated to conceal and suppress ether physics.

Since ether theory had already assumed that gravity is a function of the ether, Einstein was incorrect to treat photons the same way as material bodies, to explain the red-shift, with the theory that the photons passing near a planet were "curved by the space-time continuum", producing the spectral shift. According to the Relativists, it was supposedly proved, on May 29, 1919, "...that we live in a curved, four-dimensional space-time". Albert Einstein said a massive body spinning in space "...would drag space and time around with it...", the origin of so-called "frame-dragging"

¹Gary Taubes, Relativists in Orbit, Discover (Mar., 1997).

and "space curvature" which Tesla was so opposed to, along with Einstein's statement, "Gravity is no longer a mysterious force acting at a distance but the result of an object trying to travel in a straight line through space curved by the presence of material bodies".

In researching for more possible explanations for this apparent tragi-comedy of mistakes, I found an article by Swedish physicist, John-Erik Persson¹, who seemed to agree with me. Persson said the Michelson-Morley experiment showed that the ether is space-dependent, not non-existent. Since the observations were made by stationary equipment in relation to earth (moving at over 70,000 mph through space), it was not a valid ground for postulating Relativity. If the ether has a constant velocity V in relation to the observer, the observed velocity of light becomes a vector sum $C + V$, according to ether theory. If the observer is moving at the same velocity and in the same direction as the ether, no red-shift should be observed. Michelson's empirical results showed that V , near the earth, is equal to the velocity of the nearest part of the earth (in the horizontal plane), in agreement with an ether which was stationary near the earth. This gave rise to Relativity, which made the false assumption that an observer will always find V to be zero, independent of his own velocity, giving rise to elastic space-time concepts, which are against intuition.

What I always point out as Einstein's preoccupation with his "apparent effects", resulting from an observer's failure to take into consideration his own motion, as well as the possibility that the ether has zero velocity only near the earth's surface. This zero velocity was due to what Tesla said was the "rigidification" of the ether caused by the emanation of earth's rapidly varying electrostatic forces, which would decrease in intensity at the square of the distance from earth, as the ether would have a commensurately increased relative motion. This same rigidification of the ether was consistent with Tesla's (Faraday's, Wm. Thomson's) statement that the ether behaved as a "fluid to material bodies, and a solid to heat and light", as still another explanation for the red-shift. That would allow the ether near planets to refract the light passing near it. Persson said that the theory of the ether interprets Maxwell's results as

The velocity of Light = $C + V$.

With the missing space dependent $V(R)$ (velocity V and position vector R) supplied, the Lorentz Transformation is unnecessary, (and rationality and truth are restored to physics!). $V(R)$ must represent a description of reality, and the reality of material particles is defined everywhere by acceleration $A(R)$, concerning the distribution of matter in a vicinity. We have reason to suspect a relationship between $V(R)$ (the translational field) and $A(R)$, (the gravitational field), showing their common origin (the ether), shown by a photon (a fast wave field) added to gravity (the ether, a slow reference field). Since $V(R)$ (the fast wave field) is the distribution of matter in the vicinity, it has the same value as the nearest part of a big material body it may be near, as a more reasonable interpretation which agrees with the Michelson-Morley experiment, showing that the photon adapts its velocity to local conditions.

This means that the space-dependency of the translational field, $V(R)$, allows the theories of Newton and Maxwell to be united without any non-linear Lorentz Transformations, and that, by

¹John-Erik Persson, About an Alternative to the Lorentz-Transformation (Hagersten, Sweden, 1997).

the rule of Ockham's Razor, the Translational Field is a more plausible explanation than the Theory of Relativity.

I had always assumed that, since calculations of C made in conductors and fiber optics, require the "velocity factor" (.97 x C in free space), that such an adaptation of C to the local conditions of the conductors, disproves the Lorentz Transformation and the Theory of Relativity.

NIKOLA TESLA'S DYNAMIC THEORY OF GRAVITY

Tesla's Dynamic Theory of Gravity (c. 1893-94) was based on the idea that all bodies emit microwaves (rapidly varying electrostatic forces) of particular voltage and frequency, as determined by their "electrical content" (mass, composed of protons, electrons, and neutrons), and relative motion. Tesla measured the microwaves of the earth with a special tube he invented (you could see the peaks and nodes of the microwaves created in the gas in the tube), as being only a few centimeters in wavelength. He said the frequency and voltage were related to the velocity and mass (electrical content) of the earth, and that gravitational interaction between bodies, was determined by the vector product of the mutual interaction of their microwaves with the ether, and to electric currents and tubes of force, passing through space and between and within bodies.

Tesla confirmed this, placing two metal plates a certain distance apart, and electrifying them with high voltage, high frequency currents ("Tesla currents", or "microwaves"). At sufficiently high voltage and frequency, the space between them became "solid state". It also worked with one plate only, suspending the zinc plate (1/8" thick x 12" square, weighing about two pounds) in mid-air. This is further documented in 1943 FBI documents released under the F.O.I.A., as being witnessed by Marguerite Merrington, in an 1894 demonstration by Tesla in his Houston Street laboratory.¹

"p2"

The flying saucer uses "p2", which refers to two potentials, primaries or kinds of currents. The forward end of a saucer--"pl"—uses Tesla's tuned "Single Terminal Coil" (see page 300 for set of plans), tuned to either 1/4 wavelength, or 3/8th wavelength. It is an air-core, step-up transformer, which converts normal A.C. current to high voltage, high frequency current, which has charge-increasing effects similar to an electrostatic generator, but with a much greater reactance, due to its high frequency and tuning, which allows it to shoot out bursts of current of one sign (positive or negative) from one end, while remaining neutral or peak reverse voltage on the other end. Tesla created this coil specifically for the purpose of powering his flying saucer, even before the century began. Tesla noted and was greatly pleased by the "pseudo-electrostatic" effects of his coils. In writing a critique of the enormous Van de Graaff generator built by M.I.T. and tested in 1938, Tesla pointed out the fact that only a tiny version of one of his coils, dating from the 1890s, would outperform the giant Van de Graaff. This is because a Tesla coil uses alternating, high frequency, high voltage inductance, to throw out electrostatic, D.C. pulses. A much smaller unit will produce the necessary high voltages, through inductance, and a much smaller conductor

¹FBI Documents Regarding Nikola Tesla (252 pages), Part 1, page 49, LIST OF PERSONS ASSOCIATED WITH NIKOLA TESLA.

will carry the high frequency current, while D.C. systems require much larger conductors for the same total wattage. In MHD pumping, it has been proven that a pulsing DC, current is better than a steady D.C. current, so the Tesla coil is ideal for the flying saucer application, producing the traditional purplish brush, a facsimile to the earth's aurora borealis.

Using "p2", the vastly greater strength of the electromagnetic interaction is applied to control the very weak, gravitational interaction, to pump the ether and tubes of force into the ship and dissolve them, to impart momentum to the conductors attached to the ship, at right angles to the electric and magnetic fields, as explained in the Introduction. A relatively small amount of electromagnetic force, created by an alternator turned by a Tesla turbine, can easily dominate the gravity of a large ship, create electromagnetic momentum, and propel it at great speed.

In theory, an oscillating electric dipole consists of two equal and opposite charges of dipole moment p , where p oscillates sinusoidally with time. A dipole which is tuned to $3/8$ th or $1/4$ wavelength, will continue to throw out energy even when the conditions are reversed, because there is a time-lag between changes in charge and current distribution. The power radiated varies as the fourth power of the frequency, so the higher the frequency, the higher the reactance. The use of the $3/8$ th tuning, causes the positive and negative potentials to cross and neutralize one another on the neutral end, while emitting the desired peak negative pulses at the other. The $3/8$ th tuning is convenient where it is desirable to have a neutral connection for the lower end of the coil. Since all gravitational atomic mass has a net positive charge, the negative charges are needed to manipulate gravity. The positive mass possessed by the ether carriers, reacts with the negative pulses, to attract them into the conductor, creating and bringing along the tubes of force, which are dissolved in the conductor, to impart momentum to the conductor, with a force which is 10^{40} times stronger than the gravitational force:

$$F_e/F_g = 10^{40} \times F_g$$

The primary L-C circuit is composed of a primary coil (of few turns, using a large conductor), choke coil, spark gap, tuning coil, and capacitors. This combination produces the primary frequency for inductance of the secondary coil, of many turns, using a small conductor. The inverse ratio in number of turns and conductor size converts the electricity from low to high pressure. Tesla found that a primary coil consisting of a wide, thin, strip of metal, laid down flat between layers of insulation, was best, because it had less (undesirable) "self-inductance". This is even better with the bi-filar coil, which eliminates self-inductance altogether.

(NOTE: The following illustration was an unlabeled drawing from a patent application which Tesla withdrew, to prevent J.P. Morgan from acquiring the invention, since Morgan tricked Tesla into giving him a 51% controlling interest in "all his patents", when he funded his Wardenclyffe world energy system project. When Tesla was driven into bankruptcy, the patent didn't issue and Morgan didn't own it. Tesla made this discovery at about the time his Colorado Springs experiments ended, as a new way to produce electricity from air, shown as follows:

ALIENS62

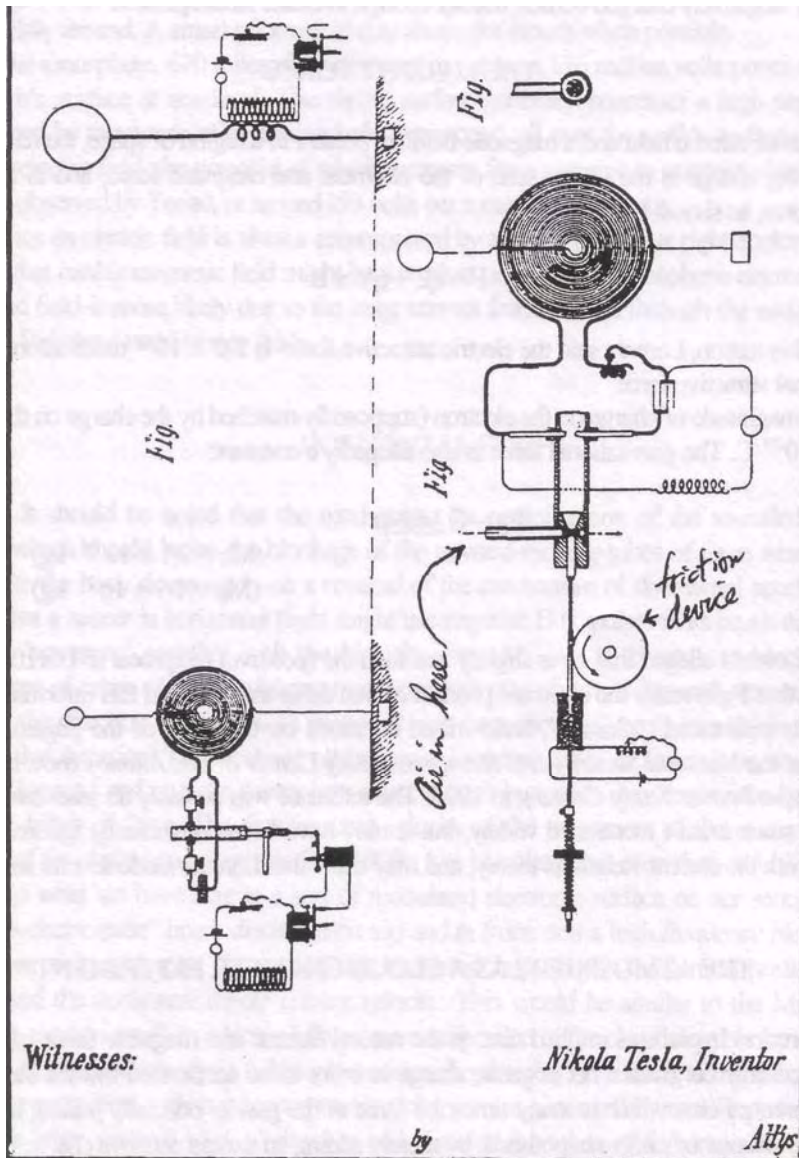

The consideration of gravity as a separate force may be superfluous, since it appears to be a naturally occurring weak electromagnetic interaction in the first place, caused by displacement of the nuclei of atomic mass downward by the upward passage of ether carriers and dissolving tubes of force, induced by the currents created by the movement of mass through space.

As previously stated, gravitational mass is almost electrically balanced and neutral. If a flying saucer has an artificially created, strong, relatively negative charge, it will strongly attract relatively positive ether carriers. Of course, where this attraction is equal in every direction, the saucer will go nowhere. Since all atomic mass, elements, and compounds have net positive charges which

exceed their normal negative charges, there will always be some electrical attractive force between matter and negatively charged bodies, but not enough to create electropulsion.

THE LORENTZ FORCE

If both an electric field and a magnetic field are present in a region of space, the resulting force on a moving charge is the vector sum of the electrical and magnetic force, and is known as a Lorentz Force, as shown by:

$$F = qE + qV \times B$$

For this reason, Lorentz said the electric attractive force is 2.2×10^{39} times stronger than the gravitational attractive force.

The magnitude of charge on the electron (supposedly matched by the charge on the proton) is $e = 1.6 \times 10^{-19}$ C. The gravitational force is also allegedly a constant:

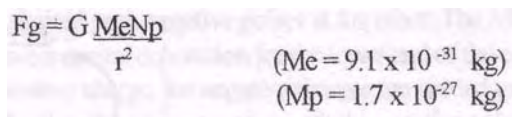
$$F_g = G \frac{M_e N_p}{r^2}$$

($M_e = 9.1 \times 10^{-31}$ kg)
($M_p = 1.7 \times 10^{-27}$ kg)

(NOTE: Lorentz alleged that $e+$ is slightly less than the (positive) reciprocal to 1.6×10^{-19} C, which suggested that F_g is really the electrical product of that difference. I found this information only by incidentally referenced ("glossed", handwritten notations on the sides of the pages) in material available at the National Security and Resources Study Center at Ins Alamos (now called The J. Robert Oppenheimer Study Center), in 1979. The reference was possibly an inadvertent "lapse in security", since it isn't mentioned widely, but it may have been conveniently ignored because it conflicts with the current Relativist theory, and may show that Lorentz made several serious errors.

THE ATMOSPHERE AS A CLOUD CHAMBER EXPERIMENT

Lorentz' hypothesis implied that, in the natural electric and magnetic fields of the earth, a saucer need only be given a net negative charge in order to be accelerated toward the ionosphere with a Lorentz Force which is many times the force of the gravity normally pulling it downward. According to Lorentz's naive hypothesis, by merely adding an excess negative charge to a ship, the force of gravity would be neutralized, just that easy! Would this not only free the craft from inertial as well as gravitational force, while also repelling it upward with the like' negative charges on the earth? I once thought that, once conditions necessary for electromagnetic repulsion have come into play, there would be no gravity. Would that it were so easy! Lorentz' silly theory was wrong! We all make mistakes.

Besides, during thunderstorms, the electric field is reversed, due to the high negative charges on the bottoms of thunderclouds, which multiply the potentials around ten times. Had Lorentz' hypothesis been true, a saucer would be slammed to the ground with astounding force, though I have often observed that saucers do experience apparent malfunctions in lightning storms, but not

ALIENS64

enough to drive them down. There must be some provision for quickly adjusting the potentials and amperage to maintain somewhat stable flight beneath a thunder cloud, as the ships sometimes jump wildly around. A smart pilot would stay above the clouds when possible.

The ionosphere, 620 miles above the earth, is at least 176 million volts positive in respect to the earth's surface at sea level. The earth's surface generally possesses a high negative charge, maintained by thousands of lightening bolts per second, all over the earth's surface. This creates a vertical electric field, the potential of which increases from negative to positive, about 50 volts per foot (as observed by Tesla), or around 150 volts per meter, on a clear day.

Since an electric field is always accompanied by a magnetic field at right angles to it, this also implies that earth's magnetic field might be a product of this earth-ionospheric electric field, but the magnetic field is more likely due to the huge current from the sun through the earth, as noted by Kristian Birkeland and Hannes Alfen.

HORIZONTAL FLIGHT

It should be noted that the mechanism for neutralization of the so-called gravitational force—which should be by the blockage of the upward-moving tubes of force which dissolve to accelerate the body downward—as a reversal of the mechanism of downward acceleration. This means that a saucer in horizontal flight might use negative D.C. pulses in its brush discharge on its top, for 'bouyancy', together with the high frequency A.C. on its bottom, to block the upward movement of tubes of force, while a stronger negative brush on (its forward, attracts the tubes of force in the direction of travel (with increased high frequency A.C. to its rear to block the tubes of force in that direction).The blockage of the upward-moving tubes of force alone, should block the force of 'gravity' and give the saucer bouyancy, though buoyancy may require the brush on top to bring in tubes of force. The direction and velocity of the movement of the saucer is the vector product of the electric and magnetic fields of the two bi-polar pairs, according to J.J Thomson.

So what we have here is a sort of modulated electronic surface on our saucer; a negative "pseudo-electrostatic" brush discharge on top and in front, and a high frequency blocking current on bottom and to the rear. The vertical dipole creates 'buoyancy'—the vertical position above the earth—and the horizontal dipole creates velocity. This would be similar to the Milliken "cloud chamber experiments", in which oil drops were suspended in the cloud chamber by adjustment of external electric and magnetic fields criss-crossing the chamber, in respect to the charges possessed by oil drops, except with our saucer, moving charges are generated by motive power within it, to affect the ether external to it, to draw in and dissolve the tubes of force to accelerate it in any direction, in defiance to the magnetic and electric fields of the "chamber" (earth's atmosphere). Superimposed over this "oil drop" environment, is a double "p2"—one to position the saucer vertically, and the other to move it sideways—by emitting negative charges on one end to neutralize the gravitational and inertial effects on the other, thus actuating the ether and creating a powerful force to effortlessly propel the saucer forward instantaneously, while the internal effects of inertia, momentum and polarity are instantaneously switched and controlled, and the mass of the saucer is liberated from the ordinary rules of gravity, inertia, momentum and polarity, with the saucer's internal (human and mechanical) contents protected from these forces.

Based on Tesla's knowledge that the production of moving negative charges was essential for the Teleforce to act upon his "electric flying machine", he invented the "Tesla coil". The coil manipulates, recreates and magnifies the forces which normally exist, between atoms, and between e^+ and e^- , to control F_g , and to accelerate a body at astounding speeds.

It is important to understand the effect of the shape of the outer hull on the distribution of the action of the force. Were the hull shaped concave, rather than convex, the force field might become focused on a point some distance from the saucer, and react so as to merely draw whatever ether carriers and tubes of force might be at that focal point, toward the saucer with astounding force. It is for this reason that the outer hull is curved above, so as to "spread" the area over which the force acts to a very large area, drawing the tubes of force in.

As pulses of high voltage, high frequency negative charges move outward to distribute themselves over the saucer surface, some combine with atmospheric gasses and "slough off" as ions, creating a "protective envelope" which shields the saucer from friction and heat, dampens the sonic boom, and creates the "beautiful corona" I observed in 1953...the "lights" often seen. I'm sure this fact makes the "Illuminati" very, very, happy, so let's ruin it for them.



Graphic by Angus Lyne

CHAPTER II: PIECES OF THE PUZZLE COME TOGETHER

Now that I have introduced you to the theory and possibilities, I will now get down to the nitty gritty of flying saucer nuts and bolts, and tell you how I discovered them, step by step, in an Odyssey which lasts even unto the present, as I fill in more and more of the details.

My "odyssey" has involved some remarkable experiences and dangers which, in a way, remind me of a movie I saw a few years ago called Zardoz, starring Sean Connery. The title was derived from parts of the title words spelling "Wizard of Oz", on the cover of the book by L. Frank Baum. The story in Zardoz entailed the education of Connery by a secret elite. Connery played a murderous barbarian, through whom the elite, who had the secret of immortality, wanted to finally destroy themselves, because they had become tired of living. They arranged for tidbits of information to be made available to the barbarian, until he figured out that they were deceiving the violent society in which he lived, through a religious hoax, preaching constant destruction and war, and spewing out weapons from a giant head, for the barbarian worshippers to use against each other, while the elite lived in complete safety, with the secret of immortality as well. As you may see, there are certain parallels between my story and Zardoz, although I am not admitting that the society into which I was born tried to completely raise me as a barbarian, or that the elite which dominates us has any intent of bringing their power to an end. The many "revelations" I have experienced, have appeared before me as if intentionally placed there by some clandestine elite. That did not happen to my knowledge, but it is creative and fun to imagine that it did.

Some have suggested that the fact that so many startling 'revelations' have seemed to have 'appeared' to me "alone", is "statistically challenging". The fact is, they appeared to me only because I was aware of them and not asleep. Had I not been aware of them, I would not have known about them. I believe that there are astounding events occurring around many people, who, if they were aware of them, and mentioned them to others, as I have done, would also be accused of telling "statistically challenging" stories. I make no claim to having any "mystical powers" which would allow me to experience things others do not. What I do make claim to is the development of my natural skills to notice such things, so that if they occur, I will recognize them.

It is too bad that the analogy of Zardoz does not fully apply to the Trilateral Commission, since they deserve to be destroyed, as punishment for the many wars they fomented, and are still fomenting, to needlessly sacrifice so many lives for an illicit profit, and to reduce the population according to parameters which only they know about, but which we can surmise.

As you will see in this book, this analogy as applied to our society and its Secret Government is more appropriate than the typical Corporate Serf will allow himself to believe. He gets up each morning in the "burbs, and drives to his job at the Feudal Corporation. He takes his Stepford Wife and love-starved children to the Church of the Brain-Dead War Robots on Sunday, and prays to the Lord of Collective Guilt for forgiveness, for the sin of having daydreamed about living a real life. He indiscriminately accepts the premises that he is "his brother's keeper", that the Marxist graduated federal income tax and the welfare system are the best way to enforce his religion on others through the state, as part of 'God's plan under our constitution', and that the Founding Fathers fully intended for our armed forces to police the whole goddamned world no matter what the cost in taxes and loss of American lives. He doesn't know that the government records every single phone call in America and stores it for a period of two weeks...and longer if they have a reason to suspect a person of belonging to a "conspiracy of freedom"...and can store that purloined

information forever (but if he did know all that, he would believe the government had the legitimate power to do so under the "general welfare" provision of the Article I, section 8 of the U.S. Constitution). He doesn't believe in flying saucers at all, but if he did, he would think they were "signs in the sky" which the Old Testament said would be seen in the "last days", or the "wheel in the sky" seen by the prophet Ezekiel. The CIA has used all these suggestions.

The flying saucer I saw in 1953 was no prophetic "sign in the sky", but presented a genuine scientific mystery. I saw no sense in attempting to address every theory of gravity propounded by others, since they were obviously wrong. I didn't waste time with UFO reports or "updates" of every type either. Government organizations like Project Blue Book were just set up to plug leaks anyway. You are already familiar with what others have said, and are obviously unsatisfied, because you are now reading my book. So I will at least try to tell you how flying saucers work, and what my theory of gravity is, while others pretend that flying saucers are non-existent or "extraterrestrial" and that gravity is still a "mystery". They look in vain for "waves" and "particles" (such as the "graviton"), and have really found nothing. Their experiments are only part of the Trilateralist science sham, and since they are still looking, they must not know, right? So I will stick my neck out, and give you my best shot. If what they say is really the extent of their knowledge, then the flying saucer would be one of those inventions which worked, but nobody who used it knew why, so if they really don't know, then I should be entitled to the Nobel Prize in physics (which is out of the question), or the Pulitzer Prize for Journalism (which I should get!).

THE ODYSSEY BEGINS

My "flying saucer odyssey" began with an infantile boy's experiences with airplanes. My uncle, Roger Benton, had a Stearman biplane in the late '30s and early '40s, which he used for crop-dusting and any other hell or hair-raising, dangerous, daredevil-type fun activity. When I was around three, Roger flew into my grandfather's ("Papa Benton's") field one day. Like a kid, Papa wanted a ride. Roger was a "chip off the old block", and inherited his love of excitement from his father. So, instead of a bronco, Papa wanted a ride in the plane.

Roger took Papa up and gave him quite a thrill, especially when he looped the plane, and Papa had forgotten to fasten his safety belt. He saved himself only by locking his knees under the instrument panel, and hanging onto the joy stick. When Roger landed, Papa was still grinning, with a pale fringe about his lips and eyes revealing his narrow scrape with disaster. But that was part of the usual for those two.

I fell in love with planes that day, as I waved to Roger, and he disappeared into the clouds. My second 'big' plane impression was when I was around four, in 1942. Our neighbor had gone into flight training, and was stationed at a base which was near enough for him to buzz the neighborhood while on training flights. One morning, after a storm had flash-flooded the street in front of our little stucco house, with around a foot of standing water, I was wading in the street and gathering frogs which seemed to come from nowhere, since we lived on a desert. As I stood in the water-filled street, the flying neighbor came over, diving toward me while rocking his wings. His pull-out was almost too late, as I stood with my hands upraised, touching one of the wheels with my fingertips as the plane passed over me, narrowly missing me with its prop as my mother stood horrified in the front yard. Quite unaware of the danger I had experienced, this to me had a very

personal meaning, rather like the two reaching hands in the Sistine Chapel mural by Michelangelo. My fingers reached up as the 'wheel from the sky' reached down, and 'contact' was made.

In 1942, my father joined the Sea Bees. After boot camp at Camp LeJeune, the Navy convinced him to transfer to the regular Navy, because of his wife and three children, since the mortality rate for the Sea Bees at that time was 97%. He was sent to San Francisco, to set up and run the west coast Navy printing operation at San Francisco Naval Depot. Our whole family soon moved to Oakland, in 1943. For those two years in California, my life was immersed with being a "Navy brat", with weekends in San Francisco, and my frequent walks to the Museum of Oceanic Art, in Oakland.

At six (1944), I found a German spy's short-wave radio, set up in the back of a trash bin behind a grocery store near our apartment building. Navy intelligence allowed me to keep it, along with another my father had found in 1942, under a bed in a hotel room during his first trip to San Francisco. A neighbor and I connected the marvelous radios to his father's antenna, and we "listened to WW II". The German shortwaves were fantastic, and I have never seen another like them. My mother threw them away one day because I forgot to remove them from the living room floor after repeated warnings.

My mother and three kids returned to Texas for the last year of the war, staying at my grandparents' place in Dayton, Texas, around forty miles east of Houston. (I later realized that this had been because of the Navy's test of the first American nuclear explosion at Port Chicago, California, on the Sacramento River, prior to the nuclear detonation at Trinity Site on White Sands Missile Range in New Mexico.)

After the war, our family returned to West Texas, where I resumed my interest in experimental aircraft, building many flying models. I took a strong interest in aerodynamics, and made hundreds of well-executed designs, plotted aerodynamic flow patterns, and even did some improvised wind tunnel tests. I belonged to the West Texas Model Airplane Club, organized by three or four WW II aces, including Bill Decker, Don Wooten, and a man named McKinzie (who purportedly was highly decorated), and others. Around 1952, at fourteen, I delivered a paper to the group and its affiliate in Odessa, Texas, on the feasibility of a glider and soaring competition, suggesting Marfa, Texas, as an ideal site. This meeting was attended by several men and boys from Odessa, such as Wally Scott and Mr. Schleymeyer, who later became international competitors, and there is now an annual international glider and soaring competition meet at Marfa. I wasn't able to be the first to start it, because my father had caught me building a full-sized glider, using our living room floor as a lofting surface, and scrapped my plans right away, because he feared I might break my neck. But that lecture, in my fourteenth year, was the beginning of the international glider competition at Marfa, started by men who had heard my lecture.

Our town, Kermit, was around 325 miles E-S-E of White Sands Proving Grounds and Alamogordo, New Mexico. My first memories of "flying discs" (the first designation) and "flying saucers" (the second designation) which were sighted in the area, was in 1946, even before the 1947 "Mount Shasta" sighting. Before I had seen a saucer in daylight, I had heard reports of them from oilfield pumpers who worked the area northward, near Jal, Carlsbad and Roswell, New Mexico, and had gotten other first-hand reports from several people who had seen them. From those reports, I knew that saucers were real, because that was before reports of them had appeared in newspapers, and the people sighting them really had no motive to say they had seen them unless it was true, since there was no sensationalism associated with the phenomenon. Some of these

people had served in the Army Air Corps during the war, fighting in the skies of Germans', either as pilots, navigators, flight engineers, crew, gunners, or bombardiers, and often compared them to the "foo-fighters". I had watched the ships maneuvering at night, but had never seen one in broad daylight, at close range, until 1953, although I had seen several discs high in the sky, at great distances, which looked like new dimes glinting in the sun, in the Roswell vicinity.

By 1950, I had talked to many people who had seen saucers over the area, and was getting impatient. I slept in our back yard for nine months each year (the warmer months usually), and had observed whole squadrons of them in the night sky. I noticed that they had a peculiar habit of turning in increments of thirty degrees, or multiples thereof. This divided the compass into twelve coordinate directions, and indicated something about their navigational and flight system.

Between 1950 and 1953, I hoped for a sighting, and never assumed that they were anything other than secret government aircraft from New Mexico. My mother had heard the rumor that they were connected to the A.E.C. and radiation, and that they were nuclear-powered, using helium fuel. We had many friends all over New Mexico, particularly the Roswell area, Alamogordo, and Deming, because our family business was the only state-of-the-art decorating source in the area between Ft. Worth, El Paso, and Albuquerque, for several years, until 1954 or so.

By 1952, I had developed a proficiency at aerodynamics, had designed and tested many experimental model aircraft, and had designed, built and tested my "ground-effects" system for autos, using a model with two engines, one to drive the wheels and the other to drive a prop on the back, which sucked air from under the belly pan. I planned on a career as an aerodynamicist and aeronautical design engineer, along with a career in art. I had, in effect, prepared my mind and senses to make rather specific observations, whenever the time came for me to have the opportunity to see a saucer up close, which I was convinced was in the near future. I had already been carefully building and testing flying model airplanes of every conceivable design, for seven years, since 1946 (when I was eight), and considered aeronautical design, aerodynamics, maneuverability, and performance characteristics as serious matters. I had also flown so many conventional and experimental designs that I could usually analyze a particular configuration and predict its aerodynamic behavior. I knew from my two 1952 propeller-driven flying saucers (powered by an "Allard 19" engine), that vertical stabilizers were essential on "flying pancake"-type designs. No fins had been seen by any of my witnesses on the saucers they had observed. This was already two years after the saucers had been sighted near our house, during which time I had hoped for a sighting. Yet, with all my intense interest in aircraft, I would not ride in a real airplane until I caught a hop' from Keesler, A.F.B., Mississippi to Texas, in a general's C-47, when I was an 18-year-old Air Force trainee.

In the summer of 1950, during the time of the sightings, I had gone to the Buffalo Trail Scout Ranch in the Davis Mountains, for a two-week bivouac with my troop.

During my stay in the mountains, cut off from the outside world, after returning from a trek lasting several days, we discovered that Manchurian tanks had rolled across the 38th Parallel in Korea. On return home, I had learned that, on the first day of the Korean War, a flying saucer had appeared in broad daylight, above the city hall across the street from our house, and had maneuvered for fifteen minutes, and that, on the following day, two saucers had appeared, and maneuvered for thirty minutes. In each case, my mother was the first one to spot them. She taught China painting classes as part of our family business. On each of the two days, she went outside to fill her bowl with water and rinse out slip, with water from a faucet on our front porch. Being a

farmer's daughter, she had a habit of surveying the sky for weather signs, shielding her eyes from the sun's glare with her hand. When she sighted the first saucer over the City Hall on June 25, 1950, she called her ceramics class out to watch, and hailed the firemen and police across the street along with the mayor, Fred Pearson. The excitement spread, and within a few minutes, much of the town was watching. When it left, it departed in an upward blaze of instant acceleration. Mother said they were like "new silver dollars", and I distinctly remember her comparing them to her sewing machine bobbin, which meant the flat, shiny, "disk" type with peripheral groove.

On the next day, the same sequence occurred, only with two saucers appearing and maneuvering for around thirty minutes, then departing very fast as before. In each case, the description sounded as if the crews had experienced malfunctions, or were lost, which were responsible for the saucers being there in the first place, rather than over White Sands or Alamogordo. I later determined that these first saucers appeared to be of a sleek, silvery, slightly older "disk" type of WW II-vintage German design of the electric type, not similar in any way to the dumpy and "top-like" kind often shown in pulp magazines. It was my opinion at the time, that they were preparing these saucers for observational use in Korea.

I was disgruntled that I had not seen them, because I just happened to be out of town, although I was only a short distance south of White Sands, and only a little over a hundred miles to the west of Kermit at the time, in the Davis Mountains. I "debriefed" everyone I could find, including my friend Ken Burroughs, who was a competent young photographer who had photographed them. Air Force Intelligence showed up, paid Ken \$250.00 for his photos, prints and negatives, and made him sign a security document. Needless to say, the photos were never published. That was a lot of money for a teenager in 1952, for a few snapshots.

By that time, I had designed over 250 different types of experimental aircraft, rockets, cars, and even boats, and had built and tested numerous models of them. As previously mentioned, I had also built a couple of propeller-driven model flying saucers, and already knew that props, jets, and rockets were not the means of propulsion. In 1955, my father accidentally included my portfolio of designs in a collection of unwanted furniture he carted away and sold to a junk store, when we moved to Waco. It was possible that some of my designs found their way into the rocket and aircraft fields, judging from material I saw when I worked in Air Force Intelligence in 1957, since my book containing them was purchased from the junk dealer, whose store was right on Highway 302, before I could get it back.

MY FIRST DAYLIGHT SIGHTING

In late summer, 1953, just before school began, we had our last family ice cream party of the summer, in our back yard. Home made ice cream had been a tradition in our family for as long as I can remember. There were my parents, Raymond and Caleista, my older sister, Ramona, and my younger sister, Liz. Liz sat on a towel placed on top of the large, wood-sided, old fashioned, three-gallon ice cream freezer, as I turned the crank, while my father chopped ice and fed salt into the brine. The ice cream was almost ready, and I could barely turn the crank. We were joined by the young daughter of our neighbor, Allen Pike, a former fullback at T.C.U. Pike's daughter, Carla, had been wistfully looking through the fence, her mouth watering at the possibility of eating some of my mother's delicious peach ice cream, so we invited her over to join us. We were also joined by our tenants, the Humphries. Mr. Humphries was a leather-faced tool pusher for a local drilling

company, and Mrs. Humphries still carried herself with the demeanor of her former wartime occupation as an officer in the "W.A.C.s" (Women's Army Air Corps). She had eyes like a hawk, and had already been an expert shot with pistol and rifle, before she took up and mastered the twin 50 caliber machine gun. She had light brown hair, and a beautiful aquiline profile like that of a Kiowa princess, similar to that of my Aunt Sina. She worked as a substitute teacher in our junior high school, and had also been the former WWII Chief of Aerial Gunnery Instruction, at the U.S. Army Air Corps Aerial Gunnery School, at Sarasota, Florida, at the rank of captain. Whenever our B-17 bomber crews took gun-camera film of any new German aircraft, such as the infamous "foe fighters", she was among the first to know, since it was her duty to immediately develop and integrate into her gunnery training program, whatever new instructions required, to insure that our gunners were prepared to defend our bombers from any new forms of enemy assault. She was therefore not only a qualified expert aircraft spotter and identifier, but was the chief American gunnery instructor as well. I myself had practically memorized Jane's Handbook of the Aircraft of the World, and had discussed aircraft on several occasions with Mrs. Humphries, who had observed with a cool, detached candor, my construction of flying model saucers, and experiments in electromagnetism.

The time of day was near sundown, with the late August sun around 15 degrees above the horizon on the right, to the west of our yard. We sat near our rear fence, as little Carla, around seven, sat nearby.

As I struggled with the increasingly stubborn crank, while Liz tried to hold the freezer down, and the dasher trudged through the ever-thickening ice cream, I happened to glance up at the sky above Liz's head, in the direction of a nearby new water tower to the south of the town's old one. To my amazement, hovering there, at an angle of around 45 degrees above our position, at a distance of around 300 feet and an altitude of about 200 feet, was a flying saucer.

The saucer was precessing at an acute angle of around 45 degrees, at a frequency of around two cycles per second. Sunlight, from the horizon to our right, shimmered across the striated, silvery, bright metal hull, on each precession. A visual comparison to the water tower near and to the rear of the saucer, showed its diameter to be close to 50 feet. Its shape consisted of two evenly curved semispheres joined at the edges. This was unlike the earlier, 1950 versions seen by my mother and sisters. A cloud of "corona"—high voltage electricity emitted by the hull—throbbed orange-pinkishly with each precession, and scintillated into ghostly, silvery blue in the surrounding space, as a gentle westerly breeze wafted the coronal clouds softly about.

The two entirely symmetrical, "wok-like" halves, each having an arc of approximately 120' radius of curvature, formed a ship approximately 10' thick.

The high angle precession created an initial optical illusion, which explained why my mother had mistakenly thought the saucers she saw in 1950 were flipping like coins, end-over-end, while hovering. Mother's sightings were in the early afternoon, with the sun almost directly above her saucers, producing a silhouette effect. This created an inverse illusion, by the large angle precession of the elliptical shapes under those lighting conditions. The low angle of the sun during my sighting, however, and the shimmering sunlight dancing across what appeared to be a spun metal hull, which was highly reflective, as the saucer precessed, produced a clear picture of the movement and shape. Even so, I too was initially baffled until I established the proper movement. The coronal discharge and scintillating, rainbow-colored clouds produced, added a beautiful,

ghostly "special effect" to the ship. It was easy to understand why many viewers might get excited by "extraterrestrials", since the event was almost, but not quite, unearthly.

I immediately exclaimed, "Look at that flying saucer up there!" Everyone looked to see it, except Mrs. Humphries, who only allowed her eyes to dart once at it, instead of staring at the saucer. She was more interested in viewing me from my left, as I looked back and forth between the saucer and her, attempting to get her to look at it. I asked her, "What is that?!" She merely cocked a knowing and sophisticated left eyebrow, and shrugged

After perhaps ten seconds of hovering, the saucer began to move slowly at first, due west, toward Ft. Bliss and the southern extreme of White Sands Missile Range. It left a 'buttermilk' trail of silvery, scintillating atmospheric ions, which lingered and sparkled, gradually fading away. As the rate of acceleration and frequency of precession increased, the angle of precession decreased to a mere high-frequency wobble, as it suddenly shot forward to hundreds of miles per hour, at which time it made a 90 degree turn down and a second right angle back to horizontal, then accelerated to infinity, in approximately three seconds, as I counted off "...thousand-and-one, thousand-and-two, thousand-and-three...". I roughly calculated the velocity at near 9,000 m.p.h., based on an approximately 7.5 miles distance required for a 50-foot diameter object to become an infinite point above the horizon, in three seconds. This was a minimum calculation, which I believe was fairly accurate. My eyesight was at least 20/30 at the time. The rapid change to lower altitude seemed designed to diminish the visibility of the ship by the public, when the flight crew suddenly realized that they were over a town.

There was no sonic boom, perhaps because such rapid acceleration gave a boom insufficient time to develop, and other reasons which I was bound to discover.

There were no obvious protuberances or windows that I could see on its surface. It was as if, at high speed, the pilots—who may have had relatively primitive navigational, flight control, and visibility devices—had accidentally strayed over our town, or malfunctioned, requiring some re-orientation to get the saucer back to their base at Ft. Bliss or in New Mexico, which, at that speed, would have taken every bit of 1.93 minutes to reach. I later satisfied myself by concluding that it was a German pilot instructing an American pilot, on how to operate the saucer. Due to poor visibility on the early model, they may not have realized that they were over a town, and when they had, they rapidly departed. In that area, at that time, one could fly for miles over the barren Southwestern landscape, without seeing a town or person.

The most significant 'surprise'—aside from the electrical corona discharge—was the precession and its particularities. Since it was most pronounced when the saucer was hovering, I considered the phenomenon as being closely linked to the power level, in which the ship was on the balance between "gravity" and "no gravity", during which the circling polarity of the accompanying magnetic field created by the electric currents, swept around counter-clockwise, as well as I remember it, thus creating a minimal sweeping gravitational pull. The fact that the ship quietly hovered, dispelled the idea that jet, rocket, or propeller-driven propulsion was involved, and indicated an anti-gravitational propulsion by electrical means. I entertained the idea that the 'gyroscopic' action of the ship may have been due to an internal device, such as an engine, which rotated. Since the ship precessed while hovering, like a gyroscope on gimbals, any considerable rotating machinery could have produced the gyroscopic precession. This was consistent with the idea that a rotating engine and electrical generator caused the precession, since the rate of precession increased, while the angle of precession decreased, as the saucer's acceleration

increased. The idea that the propulsion system was "gyroscopic" was negated by the fact that the turn was perpendicular to the (vertical) axis of gyroscopic precession, and was a "power turn".

The answers to all my questions were delivered by my flying saucer, in as glorious a manner as one could rationally hope for, and then some. While I knew at the time that the propulsion system was electrical, it would take me many years to discover exactly how the "electro-physics" applied.

There we were having our last ice cream supper of the summer of 1953, near dusk, on a lovely end-of-the-summer day. And just as the ice cream had thickened to its final state, and I happened to look at the sky above my sister's head, there it was, ghostly gyrating in mid-air, no more than 300 feet away, as the beautiful wisps of electrical corona drifted across the metallic shell and into the air, then faded with a twinkle, like stardust from a magic wand which had just passed across the sky.

I observed the colors of the corona at hovering power, which ranged from a bright white, through every color of the rainbow. Generally, the color was a "pink and blue", with gold highlights and purple undertones. The corona was not too unlike the flame produced by burning zinc, such as when a welding torch was being used to cut galvanized steel pipe. Very beautiful. The corona was emitted from the entire shell at hovering, with a negative corona at the top, as the wind blew gently from the left. Each time the saucer precessed, the wind wafted the corona around on the surface and in the air. The gyrating saucer reminded me of a precessing gyroscope. But the saucer shell itself did not rotate, and the corona did not come out of vents, because there were none.

The air in contact with the surface fluoresced orange-red, in "throbs", which corresponded to each cycle of the saucer's precession, on its bottom as it turned into the wind from the left and in shadow, away from the sunlight from the right. I concluded that the 'throbs' were probably due to the increased visibility of the corona in the shadow, due to the increased light contrast. This created the illusion that the corona came in 'throbs' which corresponded exactly to the precession, which was only the product of the relative light and dark which revealed the corona more in the dark. The corona was still there on the light side of the saucer, only you couldn't see it because the light was too bright.

The precession generally matched that which I had experienced in a friend's new 1954 Buick, at 120 mph. As the car approached 120, it began to precess, as it sped down the highway, rolling around on the coil springs, which scared us a bit. At that speed, the angle of precession was at its maximum, and the precession frequency was at its minimum, of approximately 2 c.p.s. As we passed through 120, and sped up to 135, the precessional angle decreased, and the precessional frequency increased, until it was a mere "shimmy", behaving in much the same manner as the saucer. In fact, we were greatly relieved to be traveling at 135 rather than 120, where the precession was so scary.

At very high speed, the two turns which the saucer had executed were precise, square ones, and it did not 'swing out' at the corners. This boggled the eyes, since one never sees things do that, except on some mechanical devices, which hold moving parts into position with rigid guides. At hundreds of miles per hour, the effect was eerie. The movement indicated that the saucer experienced none of the effects of momentum and inertia, and therefore operated on a principle which controlled these forces, and created 'synthetic', instantaneous momentum by increasing in the new direction of acceleration. Since the forward edge emitted a 'hairy' (i.e., negative) corona during the rapid acceleration, the electrical polarity was indicated. Since the ship made instant

square turns which were perpendicular to its vertical axis, the idea of an internal "gyroscopic" drive system was contraindicated. There was no sound, hence no perceptible aerodynamic or "Coanda" effects.

The saucer accelerated much faster than a jet, rocket or propeller-driven craft could have, and had no visible or audible jets or rockets, orifices, pods, intakes, or shapes. It went from a half mile away to infinity in three seconds, appearing to have achieved a 9,000 m.p.h. velocity almost instantly, although it could have been as high as 25,000 mph.

The metallic shell was similar in color to aluminum, only somewhat duller, with concentric striations on its surface, like a 'spun' "wok" shape. The striations were approximately 1" wide and rather crude, indicating perhaps a technical difficulty in fabrication, such as that experienced in early, large-scale "spin-forming" of the shells on very large vertical lathes, using new, special tungsten alloy discs. A friend, who had worked in a secret government factory, in Amarillo, Texas, in the '50s, described how they fabricated such semi-spheres around 50' in diameter in that same manner. The shells were then shipped to New Mexico. When one of the work crew asked what they were for, he was told they were "shells for flying saucers", and everyone had a good laugh.

As the saucer precessed, sunlight played across the striations on the bottom, like it does on the microgrooves of a silvery compact disc, or of an aluminum pan.

I had made the rough estimate of its diameter by visual comparison to the new city water tower behind it and slightly to the right. The approximate height through the center was visually extrapolated from the diameter, together with the proportionate spherical sections used, and the height-to-diameter proportionality.

What I saw in 1953 was a flying machine. The most irrational assumption would have been that it was "extraterrestrial" in origin. The most rational assumption was that it was made by human beings, and that was my first impression. The puzzle parts I had gathered that day, added to what I already had, eventually grew, until I had enough to fit together to substantiate what I believed on my first impressioa

There were many sightings occurring at that general period of time, especially in that area. That particular saucer was noted by Wink Air Station, about 10 miles away, according to my brother-in-law's relative, who worked there. Wink Air Station was south of the flight path, which was on a bee-line precisely due west toward the northern edge of Ft. Bliss, Texas, where Wernher von Braun was at that time. Had I not been viewing the saucer while it hovered, and its flight to the horizon, almost directly along its trajectory, it might not have been visible.

As I thought about the performance characteristics, I concluded that the field of aerodynamics would soon become obsolete. This led me to abandon my plans to become an aerodynamicist, although I still wanted to be an aeronautical engineer. After all, the saucer was powered by electricity, had canceled inertia, momentum and gravity, made no sonic boom, and apparently ignored aerodynamics. I assumed the aircraft was classified at the time, but that it would only be a matter of no more than five to ten years before it would be declassified, just as other aircraft had been. At the time, I assumed that the general public would be using flying saucers by 1960. How wrong this turned out to be! The longer I waited, the more I became determined to know why.

In 1953, at the time of my sighting, I assumed that the saucer was a "secret government project". By 1963, I confirmed instead that it was a "Secret Government" project, and began viewing all government statements as being intended to maintain that secrecy. By that time, I also assumed that the Soviets did not have the saucer, as we knew it, even though Habermohl,

purportedly one of the top German flying saucer scientists, had gone to the Russians in 1945, and we ended up with Miethe and Schriever. Neither of these two men appeared to have anything to do with the electrically-powered saucers, and their projects were probably misinformational. I eventually considered the assumption that the Soviets also had the saucer even more improbable, "hinging" on the question as to whether or not Habermohl had access to the particular secrets involved, and whether he told the Soviets about them if he did. It is more probable that Habermohl, whose ideas were of the lowest order in the "flying saucer hierarchy", was purposefully 'sacrificed' to the Russians to mislead them, and that the Russians incorrectly assumed that he would have told them everything he knew, while he may have given them only misinformation. The CIA could have put a lot of money in a Swiss bank account for him, while the Soviets continued to treat him like a king. Besides, the kind of saucers under development by Habermohl and Schriever were of the jet and rocket powered "boundary layer" type, not the electric type, and really posed no risk to the "real" "p2" flying saucer, based on Nikola Tesla's original discoveries, acquired by the Nazis and purportedly being developed by Miethe, under von Braun's immediate supervision, from his research and development centers at Peenemunde and in Bavaria.

The Nazis were very shrewd, developing several different types of saucers—some aerodynamic, but only one electrical—at different locations using different designers, but they would never have developed the "real" ("KT-p2") electrically powered saucer outside Germany, such as in Czechoslovakia, where Habermohl and Schriever worked. The Czech projects appeared to be purely disinformational. It is probable that the only military organization made privy to all these secrets was the SS, as suggested by evidence purportedly from Wiener Neustadt, in the Austrian Bavarian Alps, and at General Otto Skorzeny's special SS commando headquarters near Munich. Skorzeny's groups' specialties included rescues. The saucers were purportedly viewed by the SS mythically, as the Vimanas of the SS Aryan philosopher-rulers, according to the neo-Platonist Nazi religion.

There has been a very carefully executed conspiracy to conceal real photos of what I call "real flying saucers"—those of the purely "electro-propulsive" type—from the public. The O.S.I. has seen to it that many fake photos and configurations have been 'inserted' into the mainstream, to confuse the public not only as to the real shape of these saucers, but to the means of propulsion. I have encountered very sly O.S.I. attempts to propagate the idea—within more 'intelligent' "UFOlogy" circles—that the Felix Schauburger designs (which were non-electro-propulsive, claiming use of an "implosion turbine"-driven 'duct fan', which put them definitely in the "low-tec" category, somewhere in the category of a glorified air conditioner vent)—were the kind developed by the Nazis. From the numerous photos of flying saucers—some real, some fabricated—it is difficult to determine with relative certainty the stages of development which the 'true saucer' has undergone. Many of the photos are obviously hoaxes, and all the types proffered by the "German-genesis" bunch are disinformational, or based on data derived from CIA-generated disinformational sources, so I will try to show you what I saw in 1953, and you can draw your own conclusions. The illustration shown below should give you some idea of what the particular type of saucer I saw looked like:

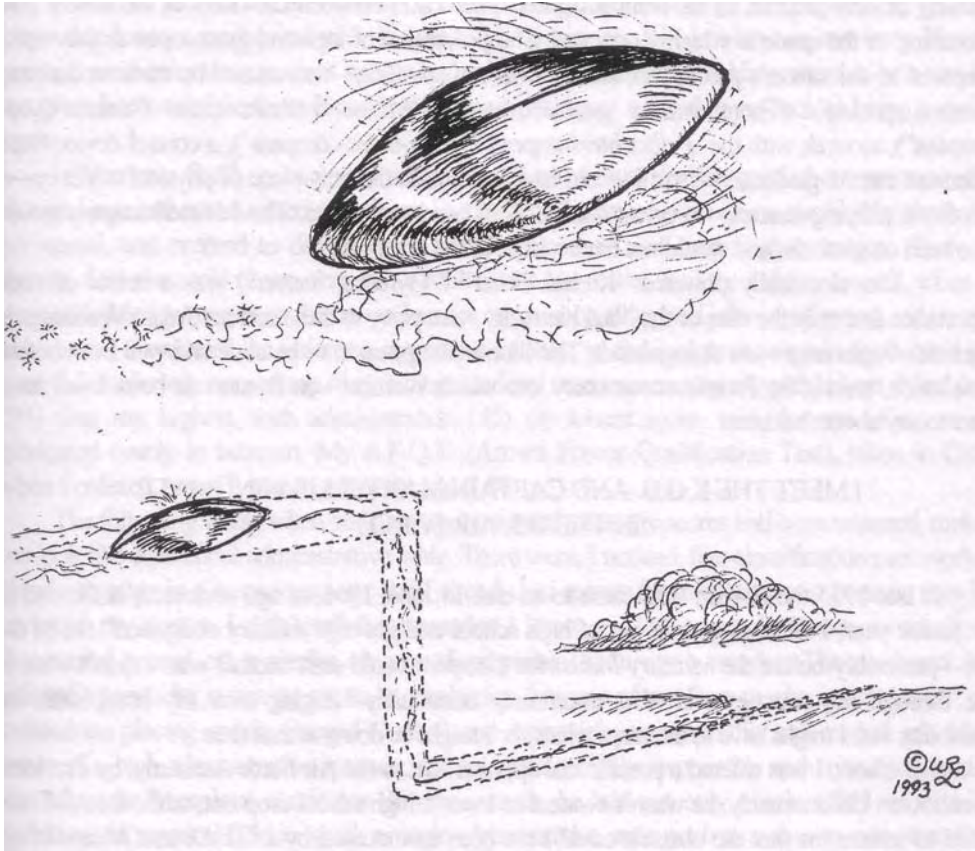

I knew by the way that the saucer could 'jump around' in space, that its gravity was being controlled. Otherwise, it would have flown to pieces, and any pilot would have been slammed around so badly that he would have been injured and rendered unconscious by the "G" forces. I knew from the electrical corona, and the 'buttermilk' texture of its corona trail, that the means for controlling gravity high voltage electricity, and included at least some sort of high frequency electricity. I knew also that the saucer disobeyed conventional rules of gravity, inertia, momentum, aerodynamics, aeronautics, and physics.

A rounded surface will hold charges better than those of a small diameter or sharp points or edges, which will 'leak' charges more quickly, and cause corrosion and burns. A corner of 90 degrees or more, will reflect waves being emitted from the top or bottom. This to me explained some of the saucer's physical shape parameters. The emissions seemed to originate on the top surface on hovering—with positive corona on its bottom—and at the front when accelerating.

In attempting to analyze the cause for the precession, I concluded after many years of deliberation, that it was not caused by a 'spinning' mass inside the saucer, such as a gyroscope or

motor, or the saucer itself, but was caused by the same unidentified, underlying reason that spinning objects precess, in an electromagnetic interaction between the mass of the saucer and something in the space in which it operated. The precession of tops and gyroscopes as they spin, compared to the saucer's precession, since it was not spinning—was caused by some underlying common principle. There was a guidance system Meisterkreiselkompass ("master-gyro-compass"), to work with the Peiltochterkompass ("polar-slave-compass"), a control device from a German inertial guidance system I would later acquire, as the only piece of physical evidence—a part from a flying saucers—in private hands—my hands—thus far. The Meisterkompass would have been on gimbals, and would not have related to the precession.

The electrically powered "Kreisel Teller" ("Gyrating Saucer") was a secret of such importance that only the elite of the Nazi hierarchy were privy to these secrets. Adam Weishaupt's Illuminati beginnings were at Ingolstadt. The Illuminati appeared to be alive and well even before Weishaupt, among the Prussian aristocracy into which Wernher von Braun was born. I will have more to say about this later.

I MEET THE K.G.B. AND CAPTAIN MANTELL'S WINGMATE IN THE U.S. AIR FORCE

In late 1955 the Korean War came to an end. In June, 1956, at age seventeen, at the end of my junior year, I decided to drop out of high school and get my "military obligation" out of the way—preferably before the Military Industrial Complex could start another war. I didn't want to live through my twenties with that uncertainty continually hanging over my head, with the possibility that I might have to interrupt whatever I might be doing at that time.

Somehow, I was offered a presidential appointment to the Air Force Academy, by President Eisenhower. Unfortunately, he wasn't aware that I was a high school drop-out, while the Air Force failed to inform me that the obstacle could have been surmounted by a G.E.D. test. Meanwhile, I also wanted to be in the Air Force Band, but there were no new assignments. I was offered the position of first bugler for the National Drum and Bugle Corps, in Washington, D.C., but at the time, my disappointment over not being in the Air Force Band was so great, I failed to investigate the bugle corps offer and what a great opportunity it represented, and turned it down. This was while I was in basic training, when I was in the Lackland A.F.B. Drum and Bugle Corps, where I was first bugler. Second bugler was my best friend at the time, Kris Kristofferson, who was quickly appointed as "barracks chief, because he had two years of RO.T.C. at Pomona College. My other good friend was Eddie Heywood, of Boston, Mass. Kris' father was Army brass, and Eddie's older brother, Tom, was a Navy commander. Eddie's lather was an M.I.T. chemistry professor. I had been a Navy brat during WW II, so we all sort of fell in together and got along well. Kris and I had both gone out with the same girl, named Marilyn Wood, of Donna, Texas, who was the National F.F.A. "Sweetheart" around 1956. Those farmers couldn't have picked a better girl, even though she liked musicians.

Kris and I reciprocated for base reville and taps. We had a crack marching and performance group, and had some excellent Caribbean drummers, as well as a bagpiping member of the Black Watch of Scotland, on loan to us from the RC.A.F.

Kris was awaiting an application to Annapolis, and had another application in for flight school just in case. After discovering that I wouldn't be able to accept the A.F. Academy

appointment, and that no band positions were open, I decided that jet mechanics would be a good job, and would prepare me for my planned career in aeronautical design and engineering. I already knew that I was a mechanical whiz-kid, and didn't anticipate any problems on my tests. Besides, good jet mechanics were in short supply in the Air Force at the time. Eddie wanted to be a tow-reel operator, because of the extra hazardous duty pay, then just wanted to go back to being a civilian again.

When we finally got to our testing phase, I came away feeling good about my tests, even though I was rather exhausted at the time I took them. Later, we were given our files by the testing personnel, and ordered to deliver them to the counseling and classification section. There, an airman first class told us we were not to look at our test scores until the following week, when we were scheduled to meet with the counselors for career counseling and job classification and training purposes. I considered the order too suspicious to obey, so the minute the airman first's head was turned, I disobeyed, opened my file, and recorded my stanine scores on my pith helmet. Mechanics (95) was my highest, with administration (45) my lowest score, with the rest of my scores graduated evenly in between. My A.F.Q.T. (Armed Forces Qualification Test), taken in Dallas when I enlisted, was 97, placed me in the top 1 %.

The following week, when our files were returned to us, my scores had been reversed, making me look like a potential administrative whiz. There were, I noticed, five classification men working closely together in a suspicious way, and I already had reason for my suspicions, because they had reversed my scores. I didn't tell the counselor I knew my test scores had been reversed, and discovered several other similar obvious discrepancies with my comrades. The personnel man refused to consider assigning me to jet mechanics, because of my "low mechanical aptitude", and insisted on placing me in Ground Control and Approach, an air traffic and control job which required a high administrative aptitude, and involved a highly responsible and critical job landing aircraft under hazardous conditions. In other words, he had not only misclassified me, but had placed me in a critical field in which a single administrative error, such as assigning two aircraft the same altitude, etc., could cost millions of dollars and several lives. I already knew that the changes in my scores were made after the records had been turned over to the classification personnel, who therefore were the responsible parties in all likelihood.

On return to our barracks, I made a rapid survey of others to see how they had fared, bearing in mind that our records had been sabotaged. There were several men scheduled for counterintelligence, some to be sent to Harvard, Yale, Dartmouth, and other schools with good Slavic language programs. I assumed that many of these assignments were misclassifications, based on sabotaged scores that made the airmen involved appear to have a higher aptitude for languages than they actually had. As I later discovered, while my scores were merely reversed, those of some others' were juxtaposed in different order, or graded upward or downward.

Among the airmen being sent to counterintelligence was a young Bulgarian who was a trustworthy friend, who had been recruited just for that purpose by U.S. Intelligence. He was a fine person, whose family had been slaughtered by the Communists. The classifications personnel had probably taken a wide berth with him, but had probably blown his cover. Another guy, who claimed to be from Florida—which I did not believe, and neither did the Bulgarian—was also classified into counterintelligence. He had the same rosy cheeks and Slavic mouth as my boyhood friend, Rudolf, who was a first generation Czech-Americana I consulted with the Bulgarian, and then with Eddie, and finally with Kris, who was knowledgeable about military affairs and

procedures. Kris recommended that I report my findings to the adjutant. By that time, the personnel saboteurs had continued to do their damage, and had even managed to cut a set of travel orders sending me to Air Police School in Compton, California, even though I was assigned to G.C.A. school at Keesler A.F.B., Mississippi, near Biloxi.

I told the adjutant that I had found what I believed to be a 5-man K.G.B. cell operating in the Air Force Career Counseling Center at Lackland, and that they had probably already routed a Czech mole into counterintelligence. The adjutant straightened out my travel orders, and said he would have the matter looked into.

Months later, Naval Commander Thomas W. Heywood—Eddie's older brother—on behalf of O.N.I., came to Keesler to spend four days over Thanksgiving, 1956, with Eddie and I. He said his reason for coming involved the K.G.B. cell, informing me for the first time that the F.B.I., acting on my information, had uncovered them. Tom said he had reason to believe that the K.G.B. was responsible for certain problems I was having, and that he would see what he could do to get me out of trouble. He said that Eisenhower had transferred the bunch to the Army where they could be more closely watched. The entire incident was classified "Confidential", and Tom was breaking the rules by even discussing the matter with me. I received the same confirmation from the squadron adjutant and commander, and was also clandestinely visited by Air Force Intelligence and D.I.A. people, who were trying to help me, while the Air Force officially refused to do anything.

About that time, Arthur C. Clarke, head of the British Interplanetary Society, and a big friend to Wernher von Braun, came to Keesler to give a lecture on "Unidentified Aerial Phenomena", which I attended. Clarke concluded that flying saucers did not exist as such, and that all such sightings could be explained as natural phenomena. After his address, I filed through a line to speak to him. I shook his hand and told him, "Dr. Clarke, I enjoyed your speech, but both you and I know that you are a goddamned liar, and that flying saucers are man-made flying machines powered by electricity." Clarke chuckled and shook my hand. Two days later, I was reclassified into intelligence, as a clerk-typist, of all things (there was the uncorrected high score in administration speaking again, which the Air Force refused to correct). Both Eddie and I went to 8th A.F., S.A.C., Headquarters, 26th Strategic Reconnaissance Wing, Lockbourne, A.F.B., Ohio, near Columbus. I was then processed and cleared for Top Secret.

It seemed an odd coincidence that the 8th Air Force intelligence group to which I was attached was the same one which had encountered the first allied air assaults of the German flying saucers, and was also somewhat involved in Operation Paperclip.

While at Lockbourne, in late 1957, I met a lieutenant colonel named A. W. Clements who was on T.D.Y. there, who had been one of the lieutenants who were Captain Mantell's wingmates, at the time of the Jan. 7, 1948 incident near Mayville, Kentucky, involving a flight out of Godman A.F.B. Flight Commander Thomas Mantell, Jr., led his P-51s in pursuit of a flying saucer. His plane was completely destroyed and Mantell with it. The later account by J. Allen Hynek, in his "Operation Blue Book" report, was almost completely different from the one given to me by Lt. Col. Clements. The situation gave me cause to wonder that, should others have followed up on Hynek's footsteps on all the other reports he supposedly considered, that almost just so many other errors might not emerge, showing a consistent pattern of lies.

The way I came to meet Clements, a tall man with dark wavy hair, was because of a discussion—actually more of an argument—which I was having with a couple of intelligence officers, one a major and the other a captain. I was making my argument on flying saucers, and

they were calling me crazy, saying flying saucers were either 'aerial phenomena' or non-existent. The colonel came down the stairs, introduced himself, and said he was on T.D.Y. at Lockbourne for a couple of weeks, (from either Kentucky or Wright-Patterson, I don't recall for certain). He said he couldn't help but overhear our argument, and said he was taking my side. He told us he had been Captain Mantell's wingmate in the 1948 disaster, and gave a blow-by-blow account of the incident, which significantly differed with the account written by Hynek when they spotted the saucer, and immediately commenced pursuit under standing orders, they contacted the control tower at Godman. Mantell led the way, and was close to the saucer. The control tower patched them through to the Pentagon, which ordered them to immediately cease pursuit. Clements said that he was unable to make radio contact with Mantell, because of the strong electric field near the saucer, so Mantell continued the pursuit, within the colonel's view. Mantell's plane flew into tiny pieces and Mantell with it. There was no evidence or sighting of any weapons use. The two officers who were arguing with me had to eat crow, for there was a superior officer having direct personal knowledge of flying saucers, in a famous incident, to corroborate my argument. I thanked Clements for his honesty. The two other officers didn't call him crazy.

My theory is that Mantell's plane, at 500 mph., entered the saucer's electric field, which gravitationally neutralized the front of the plane. As soon as his plane lost its charge, the front and rear of the plane shredded together and apart in every direction, due to the sudden effects of momentum and inertia. The Pentagon's order to cease and desist was heard by Clements, but not by Mantell, and must have been intended to avoid such an incident, based on prior knowledge by Pentagon personnel as to what could happen. Otherwise, there is no case in which the Pentagon has ever ordered the U.S.A.F. to cease pursuit of any "unidentified" aircraft, while flying over the continental U.S.A. The parts of Hynek's report which were false, due to critical omissions and misrepresentations—since Clements told his story to me the same as he told Hynek—were related to the facts that they clearly pursued a flying saucer, that Clements was in view of Mantell's plane at the time of the explosion, that radio contact had been obviously broken with Mantell due to the electric field of the saucer, and that the Pentagon had called off the pursuit immediately on notification, prior to the incident. This incident has been rehashed over and over, and Clements was very clear on the fact that it was a flying saucer, and not a "weather balloon" as the government later tried to fabricate.

On the night of Nov. 2, 1957, while I was on leave from the Air Force, visiting at my parent's home in Odessa, Texas, my father was returning from a marketing trip, en route to Odessa. Just after passing through Levee and, Texas after dark, his 1957 Ford started and a few lights went out, and he had to coast to a stop in the dark, on the highway shoulder. He rolled down his window and felt a rush of air, while over his car, a flying saucer hovering only a few feet above. He sat there for around fifteen minutes before the saucer finally departed. In essence, he had been "arrested" during that time. Afterwards, he was able to restart his engine, but his lights were gone, so he returned cautiously in the dark to a Levelland motel, where he spent the remainder of the night. The following morning, at first light, he drove on to Odessa, where he ate a quick breakfast and went immediately to Sewell Ford to have his lights repaired, saying nothing about the flying saucer. After he left, I turned on the T.V. for the morning news, which included the well-known report about the Levelland saucers, including an interview with the sheriff of Hockley County. I immediately went to Sewell Ford to talk to my father.

ALIENS81

The Sewell Ford repair shop had just opened, and the mechanic was just beginning to check out the lights, as my father stood close by. I asked Dad about the flying saucer, and he asked how I knew about it. He was unaware that there were news reports concerning other sightings and incidents around Levelland the previous night. He said he had said nothing about it because he didn't want to be called "crazy". The saucer was "egg-shaped", about 200 feet long, and glowed in the dark. The mechanic said he'd never seen a car with every single light bulb blown out, without there being a blown fuse or any other evidence of a short or other electrical malfunction. I suggested that the tungsten filaments were damaged because the strong electric field around the saucer had caused the filaments to burn out or break, as the weakest links in the circuits, already weakened by their white-hot temperatures, when the saucer hovered over the car. The magnetic field in the car, induced by the strong electric field of the saucer, would cause the electrons in the light filament and circuitry to spin like crazy.

I left the Air Force in 1958, because the classification errors made by the K.G.B. in 1956 had led to an impasse, in which I eventually could not be upgraded in the field in which I was working—in Special Services P.C.U. (Physical Conditioning and Judo Unit)—until I had first been upgraded in my primary A.F.S.C., which was as an illustrator in Intelligence. The Air Force had refused to correct my test scores so that I could be classified into a field consistent with my real aptitudes. Meanwhile, Intelligence decided they wanted me back, after I had trained in the P.C.U. Using their 'secret' influence, Intelligence got the classification officer who was to officially assign the P.C.U. classification number to me after training in that field, so I could be upgraded, assign me a primary A.F.S.C. as an illustrator in Intelligence, with a secondary A.F.S.C. in the P.C.U., so that I could not be upgraded at all, until I had gone back to Intelligence for six months so I could first be upgraded there. This created a "catch 22", however, because I had already been in the A.F. for two years and had not been upgraded, so I demanded a discharge under an obscure 8th A.F. Letter, a copy of which was in my possession. The ironic fact was that, not only was I already trained as an illustrator, but there was no one on the base to train me anyway. I had attended night classes at the Columbus College of Art and Design for a year.

And now for the incident on the three Russian bombers: When I worked in Intelligence as a clerk-typist, I had 'spontaneously' devised a new briefing system during a "Red Alert", called during a snowstorm. I was the only one in my group to show up, and had to brief and debrief the S.A.C. crews before and after takeoff. That alert concerned three Russian bombers which crossed the Arctic Circle and eventually landed in Minnesota under fighter escort, picked up over Canadian air space. That was the "Bison, the Bear, and the Muskrat" incident I referred to earlier, being the three latest Russian bombers, flown by three defecting Russian pilots and landed in Minnesota. As far as we knew, it was an attack. The briefing system I devised involved color-coding, in which the map pouches I provided to the pilots identified their primary, secondary, and alternate targets by color code. That system was adopted by S.A.C., as it was very handy under pressure, and the pilots liked it, even though it was a breach of security for me to devise and distribute the system without authority. What else was I to do, since the responsible intelligence men were still at home hiding under their beds? Only survival officer, Lt. Don Cook and I, did the whole routine with only a skeleton crew. I had picked up what I knew by working in the same room Congress had rejected the plans for the three Russian bombers, so the American designer had sold his plans to the Russians. We had no defense from those planes at that time, since they flew above our missiles.

ALIENS82

The last time I ever personally heard from Kris Kristofferson, was a letter I received from him at Keesler in late 1956, in which he said he had been accepted to flight school. I later learned that he had become a Rhodes scholar at Oxford, after finishing at Annapolis, after his other application eventually came through. When he appeared as a musician in the '60s, I hardly recognized him, except for his voice and eyes. In 1956, he was rather stocky, wore a burr haircut, and even had those little rolls of fat on the back of his neck I was greatly disappointed in 1996 to learn of his connections to Col. Michael Aquino and the CIA's MK ULTRA program, in which he was a Vatican-based Project Monarch slave-runner.¹ Working with the Jesuits, eh Kris?

Eddie's older brother, Tom, eventually became the Chief of Naval Operations. It didn't surprise me, because he was always well aware of what was going on, while others were still in the dark, and had the guts to "violate" bad orders like a good American should

Ironically, the Air Force Records Center in St. Louis, Mo., was burned out, because they could never correct the damage done to the records by the K.G.B. To this day, there are still numerous claims and lawsuits resulting ultimately from the sabotage, and most people don't even know it ever occurred. If I had not stumbled across the KGB. cell, there is no telling how long they might have lasted, right under the noses of our ignorant government bureaucrats, and the fact remains that they might never have been caught. The distinct feeling I got was that I was being punished for turning up this incident, not only by the K.G.B., but by my own government as well, and that the only help I got was from people who were disobeying orders.

I never received an official word of thanks from the Air Force, and got only an unofficial thanks from Tom Heywood, and he was with the Navy!

I MEET THE PRESIDENT'S BROTHER-IN-LAW, AND ARNOLD SCHWARTZENEGGER'S FUTURE FATHER-IN-LAW, IN THE PEACE CORPS

In 1962, I applied for the Peace Corps, on a bet with J. Evetts Haley, the western historian. Our bet was that I would apply for duty in Southeast Asia, and be accepted for South America, based on "bureaucratic probability". My application was accepted for Ecuador, with training in Puerto Rico. I never tried to collect on the bet, since it was more in the nature of a joke.

While in training at Arecibo, and at the Universidad Inter Americano at Barranquitas, Puerto Rico, I had some rather noteworthy experiences. Beginning at Arecibo, I was under close scrutiny for some reason unknown to me at the time. This immediately followed a fiery speech by Fidel Castro of Cuba, in which he accused the Peace Corps of being a front for the CIA. I was followed around by certain administrative people, and even treated rather hostilely. Finally, R. Sargent Shriver, brother-in-law to President John F. Kennedy, came for a visit, and hung out with me over several days. Everyone knew who he was, even though he used a phony name. One volunteer even sculpted a limestone portrait of him. He was checking me out for some unknown reason, and seemed disconcerted that we agreed on so many things. My friend, Dr. A. Henry Sara-Nee, of Midland, Texas, had been a graduating classmate of his at Yale Law School, class of '47.

It was near this time that an old Puerto Rican man, who smuggled back and fourth to Cuba in his row boat, most urgently approached me at a rural cantina, to give me information. The story

¹Cathy O'Brien with Mark Phillips, Trance Formation of America, Reality Marketing, Inc., Las Vegas, NV (1995)

that he related to me indicated that he had observed the Russians building what I knew from his description were nuclear missile silos, equipped with I.C.B.M.S. This was the first information picked up in the "Cuban Missile Crisis", and I passed the information along, after which it was verified by intelligence people. The missiles were actually there, contrary to later false reports (supplied by the CIA) that only fake 'mock-up' missiles were in Cuba. They were apparently setting Kennedy up, and I knew it, the American public be damned.

It was also near this time that I was harassed by Peace Corps bureaucrats, because a friend and I had Puerto Rican girl friends. The friend was a Black guy named Bill, who had won the Medal of Honor in the Korean War, as a tank commander. The Peace Corps officials particularly wanted me to stop seeing my girlfriend, a school teacher named Maria, because her brother was the secretary to the Bishop of Ponce, who had called Munoz Marin a communist. Maria had participated in freedom rides in the southern U.S., and I thought it odd that Peace Corps officials should be guilty of such bigotry and weirdness. Didn't these guys ever see West Side Story? They were acting like "Officer Krupke".

I was finally 'selected out' of the Peace Corps, without any reason being given. It would not be until four years later that I would learn why.

In protest to the Peace Corps having 'separated me out', a group of Barranquitas citizens showed up with placards, in my support. They were Puerto Ricans I'd become acquainted with, including my girlfriend, her chaperone, and several others. I thanked them for their sympathy, and said my goodbyes to them, after which we were taken to the San Juan airport, thence flown back to the U.S. Though the group had little money, they later very sweetly took up a donation and sent a small gift of money and a nice card, after I reached home.

As I was preparing to depart the training facility at the Universidad Inter Americanao at Barranquitas, I was offered some damaging information on Peace Corps operations, from several people whom I had already identified as CIA agents. The information ranged from the fact that our "dance teacher" was paid \$120.00 per day, to the fact that many of the male officials abused their positions by demanding 'bed time' with some of the female recruits. What I also thought was very odd, was the fact that nearly all the Peace Corps officials and other trainees had almost nothing to do with the Puertoriquenos, and were discouraged from doing so. At the forefront of this attitude, were some people from the Union Theological Seminary. When I reached home, I was surprised to have some media people very anxious to 'expose' the Peace Corps operations. I attributed this to CIA orchestration as well.

Thanks to Walter Bowart, I read in 1994 that, according to The Report from Iron Mountain (purportedly an accidentally leaked paper of the Secret Government) that war is considered a desirable component of modern society to reduce population, and to control "...dangerous social dissidence and destructive anti-social tendencies". The military is considered a pool for "misfits...a state-supported haven for the unemployable". They conceived of the Peace Corps as a model for an alternative replacement for the non-military functions of war, to sociologically control "misfits" ...as a "modern sophisticated form of slavery", motivated by a) "intensified environmental pollution", b) "new religious or other mythologies", c) "socially oriented blood games", or d) "combination forms".

In respect to my having been "selected out" of the Peace Corps (which in view of the above report, was a positive sign), the following copies of letters and documents are included for your reflection:

ALIENS84

PEACE CORPS

Washington 25, D. C.

August 17, 1962

Mr. William R. Lyne
529 E. 43rd Street,
Odessa, Texas

Dear Mr. Lyne:

I am enclosing a letter to you which explains the policy objectives and procedures of Peace Corps selection. Perhaps after reading this, you can more fully understand the reasons for your being "selected out."

I see no reason to discuss specific reasons for your separation at this time, for evidently you had been told quite specifically by Dr. Boulger why you were separated when he interviewed you in Barranquitas. In your telephone conversation of July 12, you yourself told Mr. Krusekopf the reasons which Dr. Boulger had discussed with you.

Sincerely,

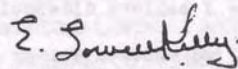

E. Lowell Kelly
Chief,
Division of Selection

Please note the evasive language of E. Lowell Kelly's second paragraph ("...I see no reason to discuss specific reasons for your separation..") in response to my letter attempting to find out why I was removed. Kelly mentioned "Dr. Boulger", whom he asserted had 'evidently' told me "quite specifically" why. To the contrary, Boulger never told me why, even though very nervous, and actually broke down in tears when I asked him for a reason. The only thing I could get out of him was a vague reference to "...something to do with my military record". Since everything about my ""military record" had been fully disclosed at the time of my recruitment, the Peace Corps had been fully informed, and there was scarcely any basis for that.

I knew that Fidel Castro had delivered fiery damnations of the Peace Corps in his radio broadcasts, which we had listened to, alleging that it was a "front for the CIA", but never imagined that I was being set up as a scapegoat. I also knew that two of my fellow recruits— John Bolin and Patricia Cohn—had fraternized with two of Castro's spies, when they had approached the training facility and entered it, just prior to those broadcasts. I also knew that Bolin and Cohn were CIA agents, along with John Barrett and a man named Salazar. It wasn't until four years later that I would realize what Bolin and Cohn had told Castro's agents, that I was a CIA agent.

In retrospect, I knew one of the men associated with the Peace Corp was a Cuban associated with the CIA forces which had attempted to overthrow Castro. He had brutally raped a friend of mine, a girl from Kentucky. Everyone knew about it, yet no one said anything about it or attempted to rectify it. She had black eyes and bruises all over her face, was dejected and ashamed, yet nothing was done to the fascist CIA Cuban pig. In distinction to this, the following letter is from a woman who, along with her friend "Libby", were kicked out of the Peace Corps for being "lesbians":

From: Inge Duvander
1881 Mulberry Drive
Hanford, Calif

To: William R. Lyne
529 E. 43rd. St.
Odessa, Texas

Dear Bill

Libby and I hoped we would have seen another big explosion in TEXAS but I'm sure you have had some problems to overcome as have the rest of us.

Libby and I went to Washington and hoped we could convince Dr. Kelly there to either give us further consideration or give us some good valid reason for rejection. A nicety that Dr. Bolanger overlooked. I had my wits fairly well about me when I spoke to but in spite of being aware of his suggested crimes I took defense to two of them and by his reasoning thereby became guilty, As Dr. Kelly quoted. Peace Corps first--the volunteer ~~xxx~~ second. So anyway no satisfaction from that quarter. Received a letter from them today in reply to one Libby and I wrote. Same evasive garbage, but he had the audacity to say Dr. Bolanger spent 45 min. discussing the situation with me. On the contrary I spent 40 min. begging for information and demanding some justice and inquiring about recourse. Laake I believe did about the same.

Well, we wrote a letter and sent copies to Pres. Kennedy, Mr. Shriver, Mr. Haddad, Dr. Kelly, and Dr. Bolanger. Other copies will be sent to my senators and congressmen. Also, I have written an apology to your Senator ~~Tim~~ Tower since I was the first to sign the protest letter to Senator Tower over the Fletcher issue.

All these little letters may not get anywhere BUT get enough of ~~x~~ them and it dirties the house. Maybe we can prevent this stupid activity from continuing and leaving more people in its wake.

1. I feel we should have been screened before we went to the training. I know they would have rejected three of us and who knows?...they may have spotted me as an undesirable in advance.

2. I think they should behave along the lines of high integrity, for this is what they preach.

3. If the Peace Corps considered the effects of social stigma on a reject, they would have to alter the selection methods.

4. Finally, few of us, when we finally decided to join, concerned ourselves with finances; not all of us could make arrangements for rehife. Also, many debts ~~xxxxxxxx~~ were incurred prior to going to Puerto Rico as well as ~~x~~ debts that would have ceased upon entering, (car payments, insurance, house, etc.)

(etc.)

Again, I couldn't understand why the Peace Corps was kicking out Inge and Libby, since it should have been obvious to any idiot who had interviewed or investigated them in the first place, that they were lesbians. With some women, you just know, and Inge was one of those women.

ALIENS86

I MEET THE CIA, ITS FUTURE DIRECTOR, AND THE FUTURE PRESIDENT OF THE U.S.A., WHILE IN THE UNIVERSITY

I picked up bits and pieces of the flying saucer puzzle during my college years, particularly when I took a freshman course in physics, at Sam Houston State University, in Huntsville, Texas, in 1963-64. At that time, I began to see the relationship between gravity and charge-to-mass ratio in individual atoms.

Later, while I attended a year of law school at U.T.-Austin, in 1965-66, M.B. Wood, the CIA Southwestern Regional Director, gave a recruitment speech to our law class¹, and said he'd be glad to answer any questions he could, if we would contact his secretary to set up an appointment, which I did. I was surprised to learn that the "sweetheart" of our law class, 'Sandy' (Kay) Bailey, was also M.B. Wood's secretary. (I was not surprised 26 years later, when in 1992 Kay Bailey-Hutchinson became a U.S. senator from Texas.) The meeting was held in a room of the Business and Economics Building, on the U.T. campus. At my meeting with Wood, I asked him point blank if he knew why I was kicked out of the Peace Corps. He reached across the desk for a dossier on me, opened it, and showed me an "executive edict" signed by John F. Kennedy, stating that "...no person who has worked for the CIA may be in the Peace Corps." I asked Wood how that applied to me, and he said "Because President Kennedy thought you worked for us." I then asked Wood if the CIA had permitted Kennedy to believe that, even though it was not true, and he said "Yes". Then he proudly showed me another executive edict dated around two weeks later, stating that "...no person who has worked for the Peace Corps may be employed by the CIA." Then Wood said, "However, we'd be glad to consider your application five years from your date of departure from the Peace Corps." As I was leaving, Wood said "Stay dry!" (old intelligence jargon, meaning "stay sensitive!").

The facts were as follows: There I was having a beer at a rural Puerto Rican cantina, listening to accordion music blaring from a Wurlitzer juke box, and just happened to pick up America's first intelligence on the Cuban Missile Crisis. Though I was not a CIA agent, this seemed of considerable importance to me, and I didn't think I should remain silent about it. After all, my family didn't even have a bomb shelter. Besides, I was in Peace Corps training, and the missile silos sounded fairly unpeaceful, so I passed the information along for the benefit of the American People and the world, not the CIA. Castro's radio broadcasts reminded me of Hitler's.

This incident proved to me what I had suspected all along, which was that the CIA was not playing it straight with the president, who was their commander-in-chief. If the president could not depend on the veracity of the CIA, as his supposed means of intelligence gathering upon which to base his decisions, then the American people could not rely on those decisions as reflecting the rational options available to the president, as betrayed by the CIA. It stands to John F. Kennedy's credit that he lacked confidence in the CIA, so much that, even after they had scapegoated me, to avoid discovery of the fact that they remained well represented in the Peace Corps in violation of the President's order, that Kennedy sent his own trusted brother-in-law, Shriver, to see if they were lying to him, which they certainly were. If they had just told me why they were kicking me out, I

¹8, supra.

could have fingered Bolin, Cohn, Barrett, and Salazar—who were not separated out—in a few minutes. They had told Castro's spies that I was a CIA agent, and then gave me the damaging material on the Peace Corps as I was departing, obviously for use in my later interviews with the media, which they had also arranged. It seemed odd to me that the president of the United States did not know who his own CIA agents were, yet I, a civilian, whom he was falsely led to believe was with the CIA, did know who they were.

If the CIA answered to a 'higher authority', then this was truly bigger than a "betrayal" of or by Kennedy, in his dealings with the Military Industrial Complex. There was John F. Kennedy—a Cambridge-educated Illuminatus (A.K.A. "Fabian Socialist")—betraying the Council on Foreign Relations' goal of British-American world imperialism, as envisioned by Cecil Rhodes, the British billionaire who, as an Illuminist, had endowed Oxford's Rhodes Scholarships program, and was a 'world-control' adherent to the ancient teachings of Hermes Trismegistus ("Thrice Greatest"), as elucidated by his favorite Oxford professor, John Ruskin. These teachings say that only an illuminated elite—which maintains a dualistic ("Hermaphroditic") difference between what is said and what is done—should rule the world

In 1968, while a graduate student in art at U.T., I attended a lecture on gravity in the physics department. I was disappointed to find that the physicists were still ignorant of the scientific basis for gravity. I was also amazed to find a grant application on the bulletin board, from the U.S. Department of Energy, for prospective PhD. candidates in physics. All the candidates had to do to pick up a \$10,000 grant, was to base their theses on the given government premise that "U.F.O.s are free-floating plasmas." This was apparently the manner by which the Trilateral Commission bought phony "documentation" to support their BIGGEST LIE, to be later used by UFologists. It also constituted a prima facie case of scholastic dishonesty.

I TURN DOWN AN OFFER FROM THE CIA TO BE "ONCE AND FUTURE KING"

I left the university and my first wife and I divorced in 1970, then I moved to New Mexico. By 1967, I had already done sketches of flying saucer control systems, having twelve directional grids, corresponding to twelve 30-degree incremental divisions of the compass, such as I had surmised from my 1950s observations of flying saucers navigating in the night sky above our back yard in West Texas. This observation would later be corroborated, at least for the early vintage saucers.

In 1973, at the Santa Fe Ski Basin, I ran across some friends whom I had known in my U.T. days, who had belonged to O.S.O. ("Organization of Students of Objectivism"), a philosophy club I belonged to which studied the literature and philosophy of Ayn Rand. The friends introduced me to a woman who accompanied them. I dated the woman on occasion over two years. In 1975, she attended the School of Law at the University of Houston, and lived with her grandmother, in Pasadena, Texas. While visiting her, after my return from a trip to Europe—on which I had embarked on the *Kraljevica*, a vessel of the Jugolinea—I was rather astounded when she and another vivacious young woman suddenly announced that they were CIA agents, and said, "...we are authorized to offer you M.B. Wood's job, with the provision that you return to your wife." You could have knocked me over with a feather! Wood was the CIA executive with whom I had met in Austin, concerning the Peace Corps. I turned the offer down. It was odd to discover that a lady you had been seeing for over two years, was all the while checking you out for the CIA. It was also

ironic that I was offered the job of the same CIA employee with whom I had met concerning J.F.K. and the Peace Corps. To make it stranger, the offer came from George Bush, the new head of the CIA, whom I had met and talked to while visiting my first cousin, Patsy, who was his private secretary for five years, at his Tidewater Oil Company office in the Nelly Esperson Building, in Houston.

It took me a while to sort out all of the pieces of that little incident. The CIA "agentrix" was the first cousin of my first wife's first cousin's wife. That cousin's wife was the sister to a (now retired) Texas Ranger, who presently lives in Santa Fe. That Ranger had taken a shot at my second wife along highway 285, in October, 1983, to scare the hell out of her. George Bush had just taken over the CIA. The girlfriend had commercial dealings with Bush, as one of the owners of a major oil company. And why did the CIA try to bribe and coerce me back to my first wife? George Bush and my first wife's father were butt-bumping buddies, in Bush's 1950s Odessa, Texas days. Beginning with George Bush's command at the CIA, my problems began in Lamy, stirred up by the CIA, in order to "motivate me" to accept their offer. The problem continued for over seventeen years.

I later determined that the 'friends' from the O.S.O. were CIA trainees, who had been sent to our club to spy on us, and to "learn how to think". The CIA had secretly used us as a surrogate think-tank. The "Oil Queen" of the CIA had given me a copy of T. H. White's *Once and Future King* as a gift a few months before, and I never knew what was intended, until I recalled the part about where King Arthur just went about his business, despite the embarrassing gossip about court caused by the carryings on of Lance and Guinevere. Well, I considered myself a notch above ol' Art, and the CIA.

In reminiscing about the Oil Queen, I am forever amazed at the confirmations I got from her, concerning the inventions of Nikola Tesla and his flying saucer. Heir to a large oil fortune with very high connections, she was in the know about energy matters of concern to oil interests; Tesla's invention of the flying saucer, free energy discoveries, and Tom Ogle's 100 miles-per-gallon carburetor, which I will tell you more about in this book.

IN 1979 I MEET A VIEJO FROM POJOAQUE AT THE FLEA MARKET, AND BUY AWW II GERMAN FLYING SAUCER NAVIGATIONAL SYSTEM FROM AN ALBUQUERQUE SALVAGE DEALER

In 1975 I began researching alternative methods of energy generation, based on the premise that inexhaustible energy can be obtained from the environment, because "...energy cannot be created nor destroyed, but only changed in form...". Since I conceive of the universe as a never-ending perpetual motion (energy) process—as the rule and not the exception—my goal was to discover ways to trick nature into producing "free energy". This involved gathering, focusing, and channeling some part of the infinite perpetual motion of the universe, through whatever work I wanted to do with it. I finally evolved what I call my "Triax System".

In 1976 or thereabouts, I had resumed my childhood research in nuclear sciences, electricity, and magnetism, which I had begun in 1947, when I was nine years old. By 1978, I had accumulated a lot of material and knowledge on the work of Nikola Tesla. As a child, my neighbor's father, Elmer Schlosser, a self-taught electronics repair man, told me about Tesla, his boyhood inspiration,

ALIENS89

while growing up in the Cimarron Territory. He told me the saucer was Tesla's invention. He gave me a lot of materials to use in my experiments with electricity and magnetism. I took the soft iron bars from the windows of the barracks from the German P.O.W. camp in Roswell, from which we'd built our new house in 1947, and used the bars in my experiments with magnetism and electricity. Some of the things I discovered seemed to defy the accepted laws of electromagnetism.

I had always presumed that Tesla had indeed invented the flying saucer, because of the way the government and Trilateralists had practically drummed his greatness from history.

By 1979, I had several operational Tesla coils, and was hunting materials in the salvage heaps of Los Alamos, Albuquerque, and Santa Fe, to use in a multitude of experiments. It was during this time that many of my new inventions and re-discoveries came about.

While browsing through a Santa Fe flea market in 1979, I met a viejo from Pojoaque, who was trying to sell an old wooden box which he had made in 1937, to carry tools behind the cab of his Model A Ford pickup. On the lid of the box, he had carved, in New Mexico "folk" style, a map showing Los Alamos, Pojoaque (with a "zia" sign around it), and the unpaved road leading to the interstate, showing "LA." (Los Angeles) one way, and "N.Y." (New York City) the other. The date ("1937") was shown, as well as the name of the project ("p2") in which he was employed at Los Alamos. The symbol for the project (a triangle with a dot in its center) was also shown. It was a scientific project headed by Wernher Von Braun. The old man said that after the project was "shut down and moved away", at the end of 1937, that he was never rehired when the "new project" (the Manhattan Project) was begun in 1942.

I knew at the time that the triangle with a dot in its center was the "all-seeing-eye" of Bel, Ra, or "God", that it was a Masonic symbol, and that it appeared on the dollar bill. I was inclined to buy the box at the time, not only as a curiosity, but also because of some haunting reason of which I was not then fully cognizant, but I didn't buy it because I was so short on cash at the time. I also thought "1937" was a little early for anything scientific at Los Alamos. The Manhattan Project originated in late 1941/early 1942. Our government was an "ally" with Germany, until the 1939 invasion of Poland (Surprised?). It would not be until a week later that I would realize my mistake in failing to buy the box, and did not remember the old man's name. Somewhere in Pojoaque or Santa Fe, there may still be an old, hand-carved wooden box, which looks like this:

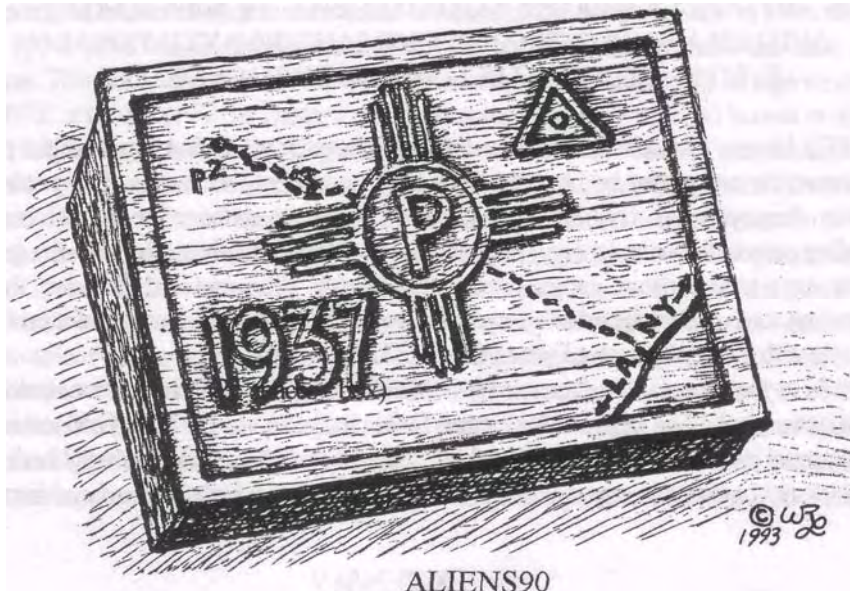

ALIENS90

The following week, I regretted having failed to buy the box, when I realized what the carving meant. This was revealed when I went to a surplus dealer's yard in Albuquerque, shortly after a fresh pile of unusual things had been sold to him by an employee of Sandia Base. On top of the pile was a navigational device of the type I knew early saucers would have used. The entire pile was not the usual stuff I was able to buy, so I asked Mark King, the owner's son, who was also a friend of mine, what he would have to have for the device. He answered, "Oh...about seven-fifty". My heart sank. Seven hundred and fifty dollars was way out of my budget. I asked, "Seven hundred and fifty dollars?" Mark answered, "No...cents, for the whole pile". I wasted no time picking the stuff up and paying Mark, with a big thanks, a handshake, a smile, and \$7.50.

When I returned home, I began to examine the device, made in 1943 by Litz, in Germany, more closely. The label on the device was as follows:

Peiltochterkompass
KT-p2
GeratNr. 127-178 A-1
Anforderz. FI 23374
WerkNr. 10143
Hersteller: gvy

There was the "p2" again. "KT-p2" was the codename for "Kreisel Teller" (German, for "Gyrating Saucer") and "p2" was, according to Tesla's drawings, either two plates, potentials, or primaries.

The 1943 device had a 6-volt motor to drive a geared ring marked in 30-degree partitions, around an inner electromagnetically coupled disk. A selection knob in the center of the face was used to manually turn a pointer to the desired flight-heading. There were fourteen contact points on the bottom, two of which supplied D.C. current to the motor. The motor would rotate the outer geared compass ring until it showed the correct flight heading, based on information relayed from "master" gyrocompass, oriented to earth's north pole, at which point the motor was automatically switched off. The term "Tochter" (German, for "daughter"), literally meant "slave" in this respect, so the term "Peiltochterkompass" meant "Polar-Slave-Compass". The device was one-half of an inertial or "celestial" navigation system. This manually operated device presupposed the "master" (gyro) compass....and electromagnetic propulsion, in 1943.

I had observed a flying saucer up close in 1953, and my father had been 'held' for at least a quarter of an hour, by another large "mother ship"—"egg-shaped" and about 200 feet long—as he left Levelland, Texas, on the night of November 2, 1957, which hovered only a few feet above his car, killing his engine and burning out his lights. Both the 1953 and 1957 ships emitted electrical coronal discharges rendering an ordinary compass useless. That and the fantastic speeds necessitated an inertial navigation system. The 1953 ship was obviously disoriented, its pilots surprised to find that they were hovering over our town, so their relatively primitive Peiltochterkompass was used to 'dial in' the proper heading, to speed back to their base along the New Mexico-Texas border, between Ft. Bliss and White Sands Missile Range, where Wernher von Braun had brought the post-war German KT-p2 Projekt.

The Peiltochterkompass had partitions of 30 degrees, identical to the 30-degree incremental turns of flying saucers I'd seen in the night sky, from 1949 to 1953. It was designed to be

mounted horizontally, with 360-degree peripheral headings, indicating a round ship, which moved in 12 directions. Photographs of the Peiltochterkompass appear below:

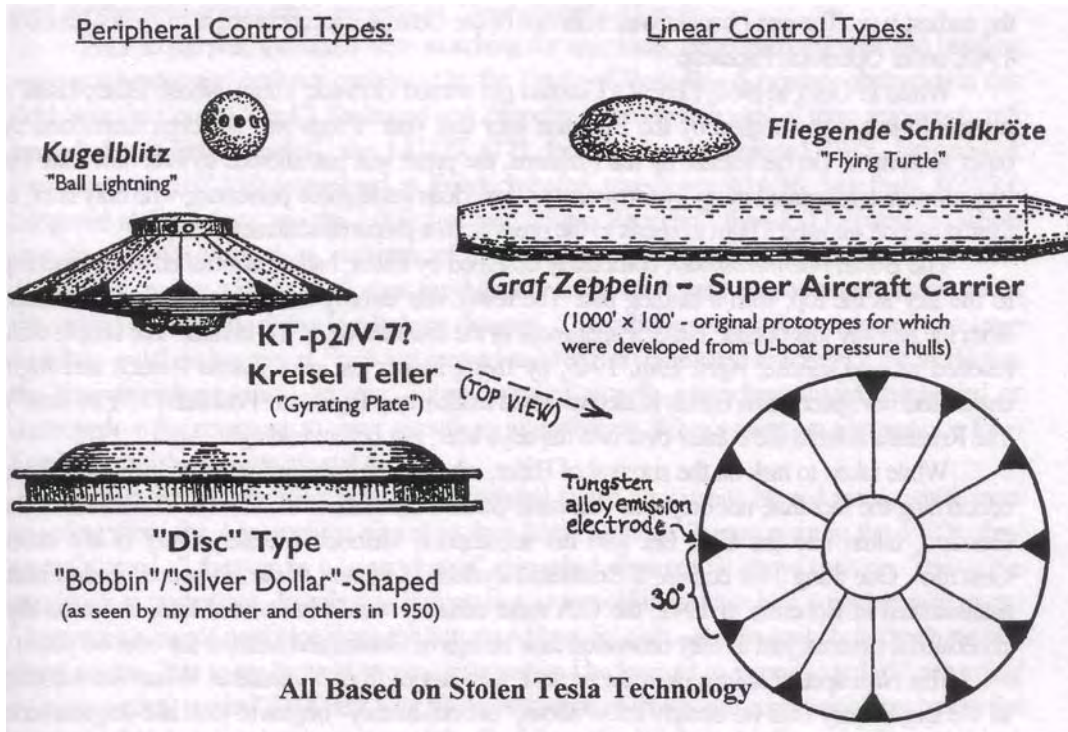

FIG. 1: Top View - fluorescent dial and face calibrations, with 12 30-degree peripheral increments. With master gyrocompass calibrated to true north prior to takeoff directional selections made with dial read on Peiltochterkompass.

FIG. 2: Horizontal rear view - label and receptacle at bottom for control cable attachment with 14 contact points, including power for 6-volt motor and 6 bi-directional polarities, interconnected to the "Meisterkreiselkompass". Appropriate high-voltage switches automatically activated via opposite pairs of twelve contacts.

FIG. 3: Perspective View.

FIG. 4: Photo of two antiquated wooden high-voltage Tesla tuning coil forms (coils missing), from Los Alamos Scientific Laboratory ("LAS.L") salvage, ca 1978. Twelve 30-degree increments on notched form primitively secured by old window latch Among stuff cleared out of "old bam" in oldest area of lab. Examination of patina, materials, screws, nuts, bolts, and other hardware, indicated a ca 1900 construction date, apparently reworked in '30s, to retrofit automotive thrust bearings. Handwriting on them comports with Nikola Tesla's. Probably part of electrical apparatus from Tesla's Colorado Springs experiments, taken south to Los Alamos for use in von Braun's 1936-38 "Illuminati'p2" project Lab personnel were probably unaware of their origin or use by the time they were released for sale in 1978.



I knew that General Patton, on his 1945 saucer-hunt, had been ordered to destroy 200 of the celestial navigation systems which he had found in a salt cave, deep beneath the Peenemunde complex. Tesla had developed and flight-tested such a navigational system in conjunction with the Sperry Gyroscope Company in 1917. The device I saw on the salvage pile met all the criteria for the device I knew had to exist, and it was made in Germany, by Litz, on October 1, 1943.

Since I discussed the device with several people, word soon reached Sandia Base Security that I had it. In their investigation, they went to Mark, who told them he had purchased it from a guy who usually brought stuff released to salvage by Sandia Base. They could not confiscate the device from me, because I had a bill of sale, and Mark had one too. Mark told me later that the security people had told him that the employee from Sandia had stolen the pile of classified salvage and sold it to him. The employee was placed under surveillance, caught doing it again, and sent to jail. Confiscating my Peiltochterkompass would have violated a security regulation prohibiting the confirmation that something is classified. The security personnel also violated that rule in their discussions with Mark. My Peiltochterkompass was a part of a WW II-vintage German electro-propulsive flying saucer, just as I said it was. Otherwise, it would not have been classified, because its design was obsolete. Otherwise, one wonders just how far behind America was.

ALIENS93

At first, I could only document what it was not. No such device was to be found in a catalogue of known WWII German nautical, aeronautical, electronic, or automotive navigational devices or related equipment. In addition, it was to be mounted horizontally. The "master" gyro retained its orientation, with reference to the earth's north pole, and relayed this information to the "slave" compass, as the central navigational device used to control electro-propulsive saucers of the earliest type. The one I bought was from one of the German saucers brought to New Mexico in 1945, under Operation Paperclip.

While in Ohio, in 1960, I knew a German girl named Gertrude Thum, whose father, Hitler's personal valet, was released by the Russians later that year. Thum was not even mentioned by other historians. On his release by the Russians, the press was not allowed to interview him. He was immediately spirited away by German and American intelligence personnel, who only later, in their presence, allowed Thum to speak to the press from a prepared statement.

The Berlin Fuehrerbunker, completely designed by Hitler, had an unfinished tower opening to the sky at the top, with a landing pad. The tower was directly accessible by private staircase from the hallway just outside Hitler's apartment in the lowest level of the bunker. The couple were rescued around sunrise, April 29th, 1945, by flying saucer test pilot Hanna Reitsch and flight expert and navigator Hans Ulrich Rudel, who had made many flights to "Feuerland" ("Fire-land"). The Russians entered the bunker over two full days later, just before midnight, April 2, 1945.

While taken to task on the survival of Hitler, other documented information has reached me, concerning the fact that, not only was Reinhard Gehlen, the head of the RSHA VI division of the Gestapo, taken into the CIA, but also his accomplice, Heinrich Mueller, Chief of the entire Gestapo¹. One thing's for certain; if Reinhard Heydrich, Architect of the Holocaust, hadn't been assassinated in Bohemia in 1942, the CIA most certainly would have hired him, and naturally, concealed it from us, just as they concealed their hirings of Gehlen and Mueller for over 40 years.

This Nazi specter haunts us in the present, with stories from Yugoslavia. When one recounts all the Big History Lies we already know about, "official history" begins to look like staged events scripted beforehand, with the complete cooperation of the leaders of all sides, to produce a certain, predictable 'ending'. Of what use is a United Nations, if it is completely impotent to stop the ethnic and religious squabbling and slaughter in Yugoslavia, with NATO finally becoming the bared fangs of the NWO 'mask'. All NATO can do is destroy a lot of real estate and create mass hysteria which is productive of nothing except more suffering, death, and the destruction of the economy of the poorest European countries, while enriching war industry manufacturers. As stated in a biographical sketch of Nikola Tesla² (in pertinent part):

"For a long time the Slav people—who, after the battle of Kosovopjölje, in which the Turks defeated the Servians, retired to the confines of the present Montenegro, Dalmatia, Herzegovina and Bosnia, and "Borderland" of Austria—knew what it was to deal, as our Western pioneers did, with foes ceaselessly fretting against their frontier; and the races of these countries, through their strenuous struggle against the armies of the Crescent, have developed notable qualities of bravery and sagacity, while maintaining a patriotism and independence unsurpassed in any other nation."

¹Gregory Douglas, *Gestapo Chief* (three vols), R. James Bender, P.O. Box 23456, San Jose, Ca 95153.

²Nikola Tesla, *Experiments with Alternate Currents of High Potential and High Frequency* (1904)

FLYING SUBMARINES?

(NOTE: Some of the following material—that related to "flying submarines"— is presented not as a "proven" fact, but as a possibility, given the many suggestive facts and mysteriously missing facts surrounding the disappearance of the German "super aircraft carrier", the Graf Zeppelin, as well as other well-documented sightings of "cigar-shaped UFOs.")

Prior to the war, the Nazis were searching for new ideas, experimenting with and building various weapons and craft not prohibited by the Treaty of Versailles. A primary contractor in this field, was the Count ("Graf) Ferdinand von Zeppelin. There were a total of three important craft named the "Graf Zeppelin", the LZ-127 (775 feet long, commissioned 1928, hangered at Frankfort), the LZ-130 (completed at Friedrichshafen, test flown 9/14/38, last flight 8/22/39, hangered at Frankfort), and the 1,000 foot long "Super Zeppelin", the LZ-131 (work on which was purportedly stopped at outbreak of war [1939-40]). The LZ-127 and LZ-130 were dismantled, and on May 6,1940, their two hangers at Frankfort were ceremoniously blown up on the second anniversary of the Hindenburg disaster¹. The rather senseless destruction of two large dirigibles and their hangers at Frankfort seemed to have been calculated to convince the world that the Nazi dirigible program—and the "Super Zeppelin" as well—were discontinued, dismantled, or destroyed—a big ceremony to cover something important up. What's more, an acquaintance from Frankfort said the hangers are still there.

Recently, a greengrocer acquaintance related to me how, while he and his daughter were traveling from the Albuquerque airport to their home in Santa Fe one night in the 1980s, they were followed all the way by a 'cigar-shaped' ship which flew not far above their car. They got a good look at the bottom, described as looking like a rusty old iron ship's hull, complete with rivets. There were a line of portholes along the bottom—like a dirigible—and he could hear the drone of a diesel engine. This to me brought to mind information I had sought to assemble in 1957, regarding a "super aircraft carrier", 1,000 feet long, the construction of which was commenced just before the war and 'abandoned', which was named the Graf Zeppelin. While in Air Force intelligence, I had first heard of the 'super ship' in a book I was reading about Patton, and was curious about its fate, so I asked my associate, a sergeant who had been a spy in the area of Hamburg at the end of the war. He told me the Graf Zeppelin had a stainless steel hull which was 11 inches thick, and when I asked him what had happened to it, he said it was "sank in the North Sea" or was 'dismantled'. He then became evasive to my further inquiries (Uh-oh! Still classified!). The existence of a "Super Zeppelin" as a supposed "dirigible", is documented in Toland's book, and as an "aircraft carrier", is documented in a naval history of WWII by Keegan Both versions were 1,000 feet long, were both 'discontinued' "at the beginning of the war", were both named "Graf Zeppelin", and were both "super". A great coincidence in names for supposedly "different" type ships.

The late model U-boat pressure hulls were "cigar-shaped", perfectly round tubes, to which were added the usual outer ballast tanks, conning towers, etc. to complete the subs. With portholes added to their bottoms, the "naked tubes" would have been perfect, ready-made hulls for ships for a "Mars Mission", such as von Braun had already planned. With a U-boat pressure hull as a

¹John Toland, *Ships in the Sky*, Henry Holt & Co., N.Y.

prototype, complete with diesel engines, batteries, and an 'hennetically sealed' living environment, and applying the gravitational-to-electromagnetic force conversion, von Braun built his first prototypes—some of which burned helium in outer space, the earlier prototypes of which belched black diesel smoke when near earth—based on "p-2". The 'rusty old iron ship's hull' seen by my greengrocer friend, was apparently one of the early prototypes, converted from a submarine hull, and later brought to New Mexico with the rest of the German projects, and now hangered at Sandia Base, Manzano Base, White Sands, or some other clandestine site.

The stainless-steel-hulled 'super' Graf Zeppelin LZ-131 "aircraft carrier"—carrying flying saucers—could have been a "flagship" from which Hitler and Doenitz could have directed the stalemate scenario at the war's end. Use of an ("11-inch-thick") stainless steel hull could have had two purposes, 1) to eliminate the need for the inner ribs and ballast tanks (the heavy weight of the hull and all internal equipment, including several flying saucers, being sufficient to submerge it in the ocean), and 2) to provide sufficient radiation shielding outside the Van Allen Radiation Belt. The stainless steel could also have avoided the resistance, hysteresis losses and inductance heating of a steel hull subjected to high frequency, high voltage currents, supplied by large Tesla coils powered by an hermetic helium generator and battery system.

Was the LZ-131 powered by helium reactors, just as my mother had heard from our New Mexico friends in 1949? Trading With the Enemy¹ documents how Germany would have obtained helium. We are told that helium is an "inert gas", but available scientific information shows that by a simple electric spark discharge, helium will produce 760 kcal./g.-atom². This is the approximate caloric equivalent to 760 loaves of bread, produced from a gram-atom of helium subjected to van de Graaff discharge. Available documents show a globular liquid helium tank (which misinformants call a "Thule Tachyonator"), reaction chamber, and an interconnected van de Graaff generator, in a German flying saucer. A van de Graaff would have been an excellent, simple way to supply the required high voltage discharges needed for helium generation of power to run the two large Tesla coils shown in the documents, probably mislabelled by the O.S.I.

With the generation of power from helium by electric spark discharge, the use of "trigatron" spark gaps takes on a whole new meaning. The spark gaps—fed by helium (falsely described as an 'inert gas' used to 'insulate' the spark gaps)—might have been the fuel for generation of high voltage electricity. I traced the use of trigatrons to 1930s Germany³.

Was the Graf Zeppelin originally outfitted to function alternately as a battleship, submarine, and Super Zeppelin/cigar-shaped mother ship/aircraft carrier/interplanetary space ship? According to Rudolf Lusar⁴, she was scuttled outside Stettin, salvaged by the Russians, and sank on the way to Leningrad. The "official" story was that Hitler purportedly scrapped the huge Graf Zeppelin super carrier before it was completed, to embark on some "very ambitious" U-boat constructions and development. The same or remarkably similar ship to the Graf Zeppelin was

¹Charles Higham, Trading With the Enemy, Dell Publishing Co., New York (1983).

²Van Nostrand Reinhold Co., Van Nostrand's Encyclopedia of Science, 5th Ed. (1976).

³Bethe, O; Kleen, Werner; Translations from Annalen derPhysik, 1931.

⁴Rudolf Lusar, German Secret Weapons of the Second World War, Neville Spearman, London 1969.

sighted off the Straits of Madagascar on June 30,1947¹. Another documented sighting of the same ship (or its identical twin) was sighted in 1962, at Hampton, Virginia²

Was the Russian salvage story a cover for the truth?. What about a (likely) story that a huge convoy of U-boats with 30,000 mile range, left Norway in 1945?

In 1945, as the Russians closed in on the Berlin Bunker, flying saucer test pilot Hanna Reitsch and Colonel Hans Ulrich Rudel, who had made many flights to "Feuerland" (Tierra del Fuego, on the southern tip of South America), piloted the flying saucer carrying Eva and Adolf Hitler to the safety of the Graf Zeppelin, from which to direct the battle during the stalemate. There, from the secret Nazi supership, Hitler made his final demands on the Allies as a field commander, and exacted his nuclear blackmail on America³. After the stalemate, the Hitlers returned to Germany under secret allied protection. Today, German flying saucer bases, such as the huge underground base built in Greenland, are probably maintained under joint Trilateral/ex-Nazi control.

The Deutsche Antarktische Expedition (1938-39) laid out Germany's claim to part of Antarctica, which claim has been undisturbed since the war. In the last coded messages from Martin Bormann, references to "Tierra del Fuego" (A.K.A., "Feuerland") were made, as the reins of power were transferred to Reichschancellor Admiral Doenitz, and his twenty-four German U-Boats surrounded the United States, armed with I.C.B.M.s (A-9s), carrying neutron bomb warheads, and with celestial guidance systems. From this position of strength, Doenitz negotiated with the Allies, during a stalemate. The Russians were overrunning Germany, but Germany had its nuclear missiles trained on the heart of America. If Germany fired the missiles, the Russians would take all of Germany, and all would be lost for the Germans, who could have bombed America, yet would have had no home to return to. Under the circumstances, only America could save only half of Germany, and so a deal was cut. Certain conditions were stipulated, and Doenitz was required to "scuttle all U-boats with all hands on board", as a part of the amnesty agreement. Certain people were guaranteed amnesty, including Eva and Adolf Hitler, who were secretly provided with a cozy and secure home in Kassel Germany, for the rest of their lives, under the protection of the N.A.T.O. allies⁴.

The story that Admiral Karl Doenitz assumed power after "Hitler's suicide" was untrue, since even available documents show that full power was transferred to Doenitz as soon as the "opera" at the Fuehrerbunker began, designed to buy time while Doenitz put Hitler's ultimate plan for the stalemate into place. If the commonly accepted story were true, Doenitz would have assumed power on April 30, 1945, with the "unconditional surrender" (signed by generals Jodl and Friedeburg at Ike's headquarters) on May 7,1945. Doenitz was not taken into custody until May 23, 1945. His headquarters was at Eutin in Holstein, within 50 miles of Hamburg. In April, they had "120 vessels [of the new "electro-U-boat" type] ready for combat", with only one of them "going into combat". That was double talk. No combat was necessary, because of the stalemate.

¹Frank Edwards, *Flying Saucers: Serious Business*, Bantam, New York (1966), p. 12.

²Paul R. Hill, *Unconventional Flying Objects*, Hampton Road Publishing Co. (1995).

³Discussion of the author with an unnamed Ph.D. candidate with access to L.B. J. 's papers at U.T., Austin, Tex., 1966.

⁴6 *supr. a.*

Meanwhile, certain Nazi commanders opened lines of communication with the Allies, ostensibly to pursue amnesty negotiations, made to appear to be without Hitler's consent, to get around Eisenhower's prior ultimatum which had already foreclosed such negotiations. Not once during this grand "opera" was Hitler ever in jeopardy of capture, and as you may know, the opera ain't over 'til the fat lady—in this case, Hitler—sings. As soon as power was transferred to Doenitz and a 'new hierarchy' installed, Albert Speer was heard to exclaim, "We now have an operatic government"¹, a statement which confirmed its purpose during the coming stalemate.

Hitler's Alpine Redoubt had significance only to the extent that last-minute technical work was being performed there, relative to the special saucer operations of General Otto Skorzeny, and nuclear weapons used in the missiles. The failure to expedite several secret emergency plans for defense of various areas of the Reich, all followed the direction of the still higher plan, being executed under the cover of the other 'last ditch' plans of which the Allies were advised. The Germans intentionally collapsed the western front on cue, to suck the Allies into Germany, so the firestorm bombings would stop, and so we could not nuke them.

In 1967, the Hitlers were invited by president Lyndon Johnson, to be his guests, during Hemisfair, the world's fair in San Antonio, Texas. The main tower of the Hemisfair, was designed by an architect who had been a high-ranking member of the S.S. As I sold paintings with a friend of mine in the La Villita area, in the seating opposite the Arneson River Theatre, along the San Antonio River, Adolf and Eva Hitler came by us, as I spotted them the moment they came into view. I had just been talking to a German "engineer"—whom I realized was a security agent, the moment I spotted the Hitlers—and Hitler took an interest in a particular painting of the Moritz Von Schwindt variety. When he saw that I recognized him, he and Eva were quickly whisked away by their security agents. My friend Bob, also a former Air Force Intelligence personnel, who sat next to me, agreed that what we saw was what we saw. This event was followed up by other security agents, who came by and talked to us, to debrief us. We played it cool. What else could we do? If we had said anything about it, who would have believed us? I have been taken to task for this sighting, but I'm sorry. There were just too many indicators to verify it. In addition, since the fall of the Soviet State, Russian military historians have admitted that they failed to find the bodies of Adolf and Eva Hitler.

The celestial guidance system used on the nuclear-armed rockets—predecessors to our Polaris missiles—and similar to the "rocket-torpedoes" written about by Ley, were of the same type found by General Patton in a salt cave at Peenemunde². Patton hit the ceiling because his superiors ordered him to destroy two hundred of the systems, which he said he could get back through Allied lines with. Our military didn't obtain such systems until twenty years later, Patton was sent to Peenemunde, on the Baltic, to pick up the files, and to make sure the flying saucer and rocket projects were cleaned out before the Russians got there, and that everything valuable was destroyed. Patton was probably assassinated, as several biographers suggested, by Army Intelligence. This was probably because of something to do with the flying saucers and Operation Paperclip. Though posthumously accused of wanting to be too soft on the Germans after the

¹William R. Shirer, *The Rise and Fall of the Third Reich*, Fawcett Publications, Inc., Greenwich, Conn.

²This documentation has been censored from Patton's war history sources I found in 1957.

armistice, it would have been more in keeping with his temperament to complain about CIA collaboration with Nazi hard liners under Operation Paperclip, and that Patton may have wanted to blow the cover on it, so they killed him. I interviewed Patton's valet, George, who was married to my first wife's aunt's maid, in Crockett, Texas:

All information concerning Patton's trip to Peenemunde has since been expunged from all current war histories that I have examined, yet it was available to me in 1957.

As for the neutron bomb, when prisoners from Rommel's Afrika Korps were brought to Roswell, New Mexico, they carried some rather strange post cards, apparently printed by Rommel's field lithographers, showing New York City being destroyed by a mushroom cloud. The camp commandant, Dave Dunn, who later became an engineer with Union Oil Company of California in their Midland, Texas Office, and who prepared the U.S.G.S. for President John F. Kennedy in 1962, thought these were humorous, and showed me one he had saved as a souvenir. The fact was, however, that Rommel's main mission in the Libyan desert, was testing the neutron bomb. The post cards carried by his troops were a 'morale builder', which superimposed the photolithograph of the mushroom cloud of the bomb they had actually tested and photographed, over a photolithograph of New York City, in a composite. The claims by the Manhattan Project members, that they built the first ATOM bomb—from German plans—was true. After all, Einstein had brought the stolen plans to us with the firm belief that we would use the A-bomb on Germany. Since the Allies had already succeeded in obtaining the German plans for the A-bomb, Werner Heisenberg merely sidestepped the A-bomb, and built the N-bomb. The question to me was not "if, but "how" (did the Germans make their neutron bomb)?

Dr. Sam Cohen, inventor of the American neutron bomb, traces the production and sale of a mysterious substance called "red mercury" to Russia¹. Red mercury is a mercury antimony oxide, specially prepared by irradiation and pressured into a gel to increase its density to create the necessary preconditions for a neutron explosion. A small quantity of it can then be used as a nuclear trigger/igniter, to detonate a small amount of heavy hydrogen, producing the deadly neutrons for a 'clean bomb'. In February, 1992, Russian president Boris Yeltsin signed Directive No. 75-RPS, authorizing Promekologia, a Russian company headed by Yeltsin's ecological advisor, to "manufacture, purchase, store, transport, deliver, and sell for rubles and foreign currency" 'red mercury', in amounts up to ten tons per year. The order was rescinded a year later because of criticism within Russia of export of such a "valuable raw material". In a spring, 1994 documentary on Britain's Channel Four ("British PBS"), a Russian nuclear chemist confirmed he had worked with red mercury since 1965, that it is currently produced in a factory in the central Russian town of Ekaterinburg, and that fusion weapons have been made in Russia from it. Cohen believes red mercury represents one of the greatest threats for potential terrorists to produce "baseball bombs" from it. He may be right.

On April 4, 1944, Nazi submarine U-859 was sunk near Penang (location of one of three Nazi far eastern U-boat bases), by the British submarine *Trenachant*. The Nazi sub was carrying

¹Dr. Sam Cohen, America Online: DJIBO (3/1/95).

33 tons of mercury to Japan¹. Perhaps the Japanese were to process the mercury, or use it in their own neutron bombs. As for how the Soviets could have ended up with the red mercury technology, a persistent rumor² has it that a U-boat rendezvoused with a Soviet surface vessel shortly after the surrender in the South Atlantic, at Mar del Plata, Argentina, and bartered Nazi neutron bomb technology for the release of German P.O.W.s in Russia.

If the Germans indeed tested a neutron bomb in North Africa, I would bet that it was produced with red mercury, since the Russians employed German metallurgists and nuclear chemists in their nuclear program, and it was they who produced Germany's WWII supply of plutonium, purer than any ever produced, so pure that it must be diluted before use, even today.

Ironically, in 1946, my father bought the buildings comprising the Roswell P.O.W. camp, and moved them to Kermit, because he couldn't get building materials anywhere else. The prisoners had done a beautiful job of converting one of their barracks into an Alpine "great hall", and used egg-tempera to paint about 100 windows to look like stained glass, with Alpine scenes, and coats of arms. They even built a sauna. Vandals eventually smashed the windows where they were being stored. Did the prisoners carry out and witness a neutron bomb test in North Africa?

What happened at Los Alamos and Mescalero, New Mexico in the late 1930s, involved Wernher von Braun, project leader at Hitler's Vergeltungswaffen development and production center at Peenemunde—which included the flying saucer project commenced in New Mexico.

Tesla had created a remarkable turbine, what we now know as the alternator, and the T.M.T., all for use on his flying saucer. He tried in vain to interest the government in his turbine and several other potentially great defense inventions, but the government showed little confidence in Tesla's abilities, and considered them too far flung to work or to be of value. In Jan., 1914, just prior to the entry of America into WW I, after the government showed no interest in the turbine, Tesla acquired a \$5,000.00 loan from J. P. Morgan, Jr., so he could finish and ship a turbine to the German Ministry of Marine, High Admiral Alfred von Tirpitz.³ Since he had already unsuccessfully offered the turbine to the U. S. government, he felt it no question of loyalty. It is my belief that around 20 years later, after unsuccessfully offering his flying saucer invention to the U. S. government, he agreed to collaborate with the Germans in the p2 project at Los Alamos.

The person who was most instrumental in inducing Tesla to work with the Germans in the "p2" Los Alamos project, aside from Uncle Sam, was a close personal friend of Tesla's, George Sylvester Viereck, who was also a close personal friend of Adolf Hitler, and was convicted in 1942 for failure to register with the U. S. Department of State as a Nazi agent.⁴ Viereck took advantage of Tesla's loneliness, shoddy treatment and lack of respect from the U. S. Government, and Tesla's need to see his project through before the end of his life. He spent considerable time and patience in cultivating Tesla's trust, thus allowing the Nazis to end up with his technology, with the complicity of the government, through the American foundations who were involved

¹Haarmann, D. H., *Geheime Wunderwaffen*, Hugen Gesellschaft Fur Politisch-Philosophische Studien E.V., Hoerstel, Germany (1985); Henry Stevens, Report Number Three, German Research Project, Gorman, Ca. (1996).

²Zeiten Schrift, 1994, p. 64. Henry Stevens, Report Number Three, p. 25, German Research Project (1996).

³Margaret Cheney, *Tesla: Man Out of Time*; Letter, Nikola Tesla to J. P. Morgan, Jan., 1914, Library of Congress.

⁴John Roy Carlson, *Under Cover*, The Blakiston Company, Philadelphia[1943]; Current Biography, 1943.

Also working in rocketry in 1930s New Mexico, was the late Peter Van Dresser, who was the originator of "Van Dresser's Constant", a mathematical constant which von Braun and others used to calculate the trajectory of rockets fired into England and Antwerp. Van Dresser was bitter and disgruntled about the fact that Dr. Robert Goddard not only got all the credit for pioneer rocket research, but also had "collaborated with the Nazis", via his pre-war work with von Braun, while he, Van Dresser, had done more important research, had no truck with the Nazis, and had gotten very little, if any, of the credit. According to Van Dresser, his rockets worked, and Goddard's fizzled, at least in the early thirties. Van Dresser used solid fuel, and Goddard liquid fuel. Van Dresser did his research independently, on his own resources, being unsupported by either the U.S. or Nazi government. And, Van Dresser was a Jewish-American.

If anyone ever saw the movie "Gadget", and remembers the guy who strapped a rocket on his back and fired it off while he was on ice skates, that was Peter. One must admit that, although the rocket knocked him on his ass and caught his pants on fire, it damn well worked! And at least he had the guts to try it out himself, right in front of a movie camera. Little did he know that he would become a part of a movie showing the wildest creations of funny inventors. Peter was very embarrassed to admit that the "rocketeer" in the film was him, because it was one of those great, yet very embarrassingly funny moments in the progress of science. I saw the movie with Peter and his wife, Florence, whom he nudged in the ribs when she exclaimed, "Oh Peter!...that's one of your's!".

So von Braun, Goddard, and the F.B.I. all saw to it that Hitler got "p2" safely to Germany. And then they traded it back to us if we'd give safe conduct to some of the criminal arch-socialists who led the German people down the primrose path to the grisly holocaust and the ghastly tribunal at Nuremberg, which left such an ugly blemish on the "German national memory". Let's take a closer look at this situation.

THE ROCKET RACKET:

Wernher von Braun, Willy Ley, Dr. Robert Goddard,
And The Kreisel Teller-p2, In New Mexico and Peenemunde

The facts in this section bring forth some very interesting questions which were missed by Charles Higham, in his *Trading with the Enemy*. Beginning around March 26, 1926, when Dr. Robert Goddard (1882-1945), professor of physics at Clarke University in Massachusetts, launched the first liquid-fueled rocket, at Auburn. In Germany, Willy Ley had read Hermann Oberth's book on space travel that year, then wrote his own first book, *Trip into Space*. He communicated with Oberth, then formed the Verein für Raumschiffahrt ("Union for Space Travel"). In 1927, Ley introduced Wernher von Braun to the Union, and was von Braun's first tutor in rocket research.

In 1927, the Graf Zeppelin LZ-127 was commissioned. It was a 775 foot long dirigible.

From 1928 to 1933, Ley was vice president of the Union. Goddard had fired the first instrumented rocket in America, in 1930. That year, von Braun assisted Oberth in early liquid fuel rocket research. In fall, 1930, von Braun joined the Union, which established a launching field in an abandoned proving ground at Ploetensee, outside Berlin (cost= \$.25/year). Experiments were conducted with 13-lb. thrust rockets.

In 1931, Ley provided the basic ideas for a liquid fueled rocket which was fired to an altitude of one mile. In 1932, von Braun acquired his B.S. degree, having studied at the Technical Institute in Berlin, and in Zurich, Switzerland. He completed 85 rocket tests that year, with rockets which reached an altitude of a mile in free flight.

In fall, 1932, the entire rocket program was transferred to Wehrmacht ordnance, with the 20-year-old von Braun appointed to head an experiment station at Kummersdorf. In 1933, nose-mounted gyrostabilizers were tested Hitler came to power that year, and the Gestapo seized all papers of the Union and the research center. In June, 1934, von Braun was granted his Ph.D. in physics by the University of Berlin. That year, a center-mounted gyrostabilizer was tested, making a 2,000 meter (c. 6,000 ft.) flight.

In 1935, near Mescalero, New Mexico (Eden Valley), Goddard's flights exceeded 700 mph., and altitudes of 7,500 feet, with financial support from the Smithsonian Institution and the Daniel and Florence Guggenheim Foundation. This attracted the attention of Ley and von Braun.

On February 21, 1935, on invitation from Goddard and the American Rocket Society (the Smithsonian), Ley arrived in New York City, thence traveled to New Mexico to work with Goddard. In 1936, Hitler took greater interest, and poured 20 million marks into his Peenemunde center, commissioning von Braun and his group to "produce a field weapon capable of carrying a large warhead over a range much beyond that of artillery".

Through Goddard, Ley arranged an invitation for von Braun from the American Rocket Society, for his visit to New Mexico, where in 1936-37, he collaborated with Goddard at Mescalero and the Eden Valley firing range, while running a secret Illuminati "p2" flying saucer project at Los Alamos. During that same time, he was still Hitler's project director at Peenemunde, in absentia. Ley must have worked on the p2 project also, because of his great knowledge of electrical science, but took out American citizenship papers in 1937, the year von Braun was appointed Obersturmbannfuehrer in the S.S. In 1938, von Braun returned to Peenemunde with "p2", and an increased knowledge of higher performance liquid fueled rockets acquired from Goddard, courtesy of the Smithsonian and the Guggenheims, and began developing the V-2 (Vergeltungswaffen No. 2 ["revenge weapon No. 2"]), with a range of about 11 miles. The Nazis lost a great scientist when Ley decided to remain in America.

On May 6, 1940, two large dirigible hangers at Frankfort were ceremoniously destroyed. They had housed the Graf Zeppelins LZ-127 and LZ-128. The "Super-Zeppelin" LZ-131 (1,000 feet long) was supposedly also abandoned A "ship"—supposedly a "super aircraft carrier", also named the Graf Zeppelin, also 1000 feet long—was also supposedly abandoned in 1940, and Hitler's interest in rockets dwindled (since the German flying saucer project, "KT-p2" was then under way?). The rocket program apparently had to be resumed, to buy more time for the KT-p2 program. Meanwhile in America, Ley became a member of the scientific department for PM newspaper in May, 1941, and on X-mas, 1941, married Russian-bom ballerina Olga Feldman. Ley had escaped Naziism in America

In 1941-42, the V-2 became 20 times larger, with a c. 190 mile range, and almost a ton payload. Before the war's end, von Braun's rockets were capable of 20-ton payloads and a 3,000 mile range (capable of hitting New York and other American cities). Von Braun fired over 3,600 V-2s into England and Antwerp. Nice guy.

Beginning in 1944 (to 1948), Ley was appointed director of engineering at Burke Aircraft Corporation, Atlanta, Ga., later made part of Washington Institute of Technology, College Park,

Maryland, just outside Washington, D.C., adjacent to the Goddard Space Flight Center. I surmise that, with his knowledge of "p2" and microwaves, Ley formed the matrix of America's earliest government-related flying saucer project, within this corporation, followed by its relocation to the environs of Washington, D.C., which indicated a very high security priority.

In March, 1945, with Russian troops within 100 miles of Peenemunde, von Braun and about 400 top colleagues left for the Bavarian redoubt—code-named the Serail—occupying a resort hotel. They were found by Operation Paperclip, and von Braun immediately signed a contract with the U.S. Army. In Sept., 1945, von Braun and 116 of his rocket colleagues were flown to Ft. Bliss, where von Braun was appointed as Technical Director, U.S. Army Ordnance Guided Missile Center. By May, 1946, V-2 testing was resumed at White Sands Proving Grounds.

In the obituary of German missile expert Dr. Ernst A. Steinhoff, in Alamorgordo (c. 1991), it was stated that during the war he was in charge of flight dynamics, guidance, control and telemetry of the German V-2s, and participated in the first launch of a missile from a submarine under the Laffrenz Project (in preparation for the missiles carried by the advanced "Electro-U-boats" in the stalemate of 1945). In 1947, Willy Ley wrote about "submarine rockets" used by the Germans during the war. Along with Germany's Dr. Heinz Fisher, Ley was one of the world's greatest experts on radar. Microwaves ("rapidly varying electrostatic forces) are directly related to gravity and flying saucer propulsion, according to Tesla's Dynamic Theory of Gravity.

In Aug., 1949, von Braun was made an honorary member of the British Interplanetary Society, through his friend, Arthur C. Clarke. During the war, he was awarded the Knights Cross and title of Research Professor ("Herr Doktor Professor") at Peenemunde by Hitler, was made an honorary member of the Gesellschaft fur Weltraumforschung, Stuttgart, and of the Nordwestdeutsche Gesellschaft fur Weltraumforschung, Friedrichstadt.

In 1950, the U.S. Army Guided Missile Center was moved from Ft. Bliss to Redstone Arsenal, Huntsville, Alabama, where von Braun was transferred as technical director. In September of 1951, von Braun's paper on an 869-day Mars mission was read to the Second International Congress of Astronautics, London (the "Super Zeppelin" probably already made the trip in much faster time, beginning in 1945). On Oct. 12, 1951, an 'unmanned' two-stage rocket (probably a reworked German two-staged A-9) reached a 250 mile altitude from White Sands.

Showing his Illuminist sympathies, von Braun once said "...As long as national sovereignty exists, our only hope is to raise everybody's standard of ethics." His rocket programs were nothing more than a cover for the IllumiNazi flying saucer technology and ether physics.

I MEET TORQUEMADA AND THE MEDELLIN CARTEL

As mentioned in Chapter I, the government of New Mexico is fascist, especially the judiciary. In Nazi Germany, the judiciary was among the last institutions to succumb to fascism. In New Mexico, it leads the way, in terms of "economic fascism". This is true perhaps because, in striking first to protect what it deems to be the "public interest", it is the lackey of the military-industrial complex, the power of which is felt through the many secret agencies connected to it in New Mexico. The judiciary functions as a guardian of the golden pipeline which channels the payola (taxpayers' money) into the state, and as such, are puppets dancing on the strings of the CIA.

The state used judicial tactics to harass me, which delayed this expose, beginning in early 1975, just after I turned down the position of 9th Regional Director for the CIA. Ever since then, behind-the-scenes agitation of, and manipulation by abusive, incessant litigation prevailed. Toward the end of this overt judicial harassment, as I was gathering evidence in the County Clerk's Office, I spotted a young man observing me from nearby, and looked him in the eye. Realizing that I knew he was a fed, he then said, "You know, of all the people we've done this to, you're the only one who hasn't broken.." That was at the end of 1991, just prior to Bush's departure from office. Harassment immediately slackened, perhaps in apprehension of a backfire. I am leaving a lot of NAMES out of this book. Many CIA field agents are naively unaware of the fact that the rats they serve are unworthy, and that their work will ultimately serve the Trilateral Commission and betray their own people. It's time to wake up and smell the coffee, or perhaps, the cocaine, smuggled by the new "Untouchables", the CIA.

The history of cocaine, in the political sense, is tied to fascism. It was the drug of choice of Hermann Goering and many other fascists. In reference to what I call "contemporary New Mexico fascism", one looks for several things. Cocaine is only one means for controlling high-placed users, such as judges, lawyers, and public officials. For example, one Santa Fe judge is an ex-pornographer who is strung out on cocaine. This gives the CIA and cartels two means of extorting what they want, in addition to protection of their supplying of the drug. The 'customer' needs the drug, and he doesn't want to be exposed as a child pornographer, so he is in a double bind. This is also why the CIA prefers corruption at the top. They copied their methods from the mob. "We'll just keep this video tape on file, and no one will see it so long as you do like we say. In addition, we'll pay you every time you render a decision like we want" (or vote a particular way, if a senator or congressman).

To raise money for CIA black operations in Central America, the Medellin Cocaine Cartel was organized by Klaus Barbie—the Nazi war criminal closely connected to Dr. Mengele, the "Angel of Death". Both Barbie and Mengele were brought to America under Operation Paperclip, but were provided new identities and shipped off to South America by the U.S. Army C.I.C., because they were too hot to handle here. Others, even though "hot", often shown by history books to be dead, got new "Amerikan" names, and were employed in America. Many of the kingpins of the cartel are the offspring of S.S. officers who married South American women, especially Colombian women. Jack Anderson, the columnist, uncovered some of these things a few years ago. Because of the Spanish history, as well as the inherent politically corrupt fascist government, New Mexico, like the "Little Havana" of Florida, is especially suited as the "cocaine capitol" Banana Republic of the central U.S. The government and law enforcement here "belong" to the cartel. Political influence can also be bought more cheaply here because the politicians of New Mexico are seedier, cheaper, smaller-time crooks. No matter what turn the politics takes, there seems to be no difference, as there has been no significant change in CIA drug smuggling in the area. A governor is without power to stop it, and would be risking his life to try.

There is a considerable amount of real estate and bank money-laundering in New Mexico, on behalf of the fascist drug marketeers, with a compliant judiciary to protect them. Even the I.R.S. cooperates with the cartel, "so long as its participants declare the income and pay the taxes due". Their attitude is that of the Federal Reserve Bank. They only want their piece of the action. They had rather collect the taxes, than to roll the dice on prosecution for evasion. The judiciary merely views the money-laundering and related big-time drug payola, in much the same way that it does

the secret government payola, all as part of an economic boon to New Mexico, and therefore within its duty to protect as a matter of "public policy".

Northern New Mexico has become one of the primary deal-making and distribution points for CIA-connected cocaine traffic in central North America. This makes New Mexico's small-time judiciary feel more big-time, and they are flattered by it. As part of the world-wide cocaine scenario, the involvement of New Mexicans themselves, is rather menial by comparison, in the capacities of quasi-lackies, sort of like "spear bearers" in an opera. It is my belief that the cartels and CIA even use flying saucers to make many of the drug shipments and deliveries, because flying saucers were among the first of the "stealth" aircraft used by the secret government. There are connections between the real estate developments here, former S.S. officers such as Colonel Otto Skorzeny (who died in 1975 in Barcelona, Spain), the Trilateralists, the Krupps (who gave us Hitler), and even Fidel Castro, of Cuba.

For example, one of my former tenants and her former Colombian doctor husband (the offspring of a Nazi S.S. officer and a Colombian woman), were involved in receiving shipments of cocaine in Encino, New Mexico, where Cuban Air Force planes, piloted by uniformed officers, delivered cargo plane loads of Colombian cocaine and marijuana. They were never caught or stopped, and obviously had the secret blessings of state and federal officials. The tenant was later shown in the papers, hugging Fidel Castro, who had muscled into the (CIA) drug traffic, by threatening to shoot down dope-carrying planes, unless the cartel cut him in for a 'piece of the action'. This was arranged through fugitive financier, Robert Vesco, a Nixon and Bush pal. Panamanian dictator Manuel Noriega was extradited and jailed by the U.S. in Georgia, because of his little stunt—forming an alliance with Castro, who cut the two in for a bigger piece of the action by threatening to shoot down the Colombian planes.

This CIA-connected dope crowd worked with a former neighbor, a former member of the Weather Underground and the Communist Party (according to information my former attorney said the F.B.I gave him), who handled at least fifteen tons of Colombian marijuana per year, picked up in approximately 100-kilo shipments near my house, in the limos driven by members of the Chicago mob. Though arrested once, she beat the rap under the "adult prosecution diversion program" which she was legally ineligible for, while all her criminal records were erased, after she put up a total of \$25,000.00 in bribes. This was mere pennies to the dealer, since, at a very conservative \$50.00 per oz., there was easily \$24 million per year in marijuana alone being exchanged, within 100 feet of my back door, and probably over \$100 million by the time it became more 'clandestine', due to the publicity of the bust, which was barely noticed in the papers. Add to this the probable take in cocaine, the total was probably twice that.

I suppose all those money-making activities by my Weather Underground neighbor were "...for ze revolution...". Sadly, the only 'revolution' being financed, was one in which the New World Order of John D. Rockefeller, Adolf Hitler, and George Bush et. al, was protracted through black operations of the CIA in Central America and elsewhere, funded by Klaus Barbie's South American cocaine cartel, spawned by the CIA's "Operation Paperclip", which is how Bush and the CIA motivated my neighbors, made me suffer, and suppressed energy and flying saucer secrets.

The judicial harassment which began in 1975, became particularly obvious (to me) in 1980, when the D.A.'s office persisted in prosecuting me on a fraudulent and abusive fish and game charge, based on tampered evidence, similar to a prior, 1975 incident created by the

Communist/dope-dealing plea-bargainer, who maliciously had me arrested on trumped-up assault charges, because her Chicago Mafia customers were complaining about my neighborhood presence. They didn't like me driving my vehicles past their windows in the wee hours of the morning, while they were trying to get a good night's sleep, prior to their pre-dawn departures back to Chicago, in the Mob's Cadillac limos loaded to the springs with dope. This was the obvious response of state and federal officers toward an innocent neighborhood bystander, who had, by his increased awareness and knowledge, threatened the Golden Pipeline of funds for CIA black operations in Central America.

A dead "endangered specie" bird was planted in the refrigerator in one of my apartments, wrapped in aluminum foil, as tenants vacated, and I was charged with "possession". This malicious prosecution coincided with the \$50,000.00 grant from the feds to the Santa Fe D.A.'s office, to investigate cattle mutilations, to be conducted by ex-F.B.I. agent Kenneth Rommel. Meanwhile, my key defense witness, former tenant Bill Englert, was killed when the single-engine aircraft he was piloting plowed into the ground in Alaska, during his last flight to Anchorage, the day before his planned return to Santa Fe to testify. After obtaining his pilot license, Bill worked as a fish-spotter for Alaskan fishing fleets near Anchorage. I speculated that his plane had been sabotaged prior to his last takeoff, just to prevent his testimony, since there were those present with him in Alaska, who worked with my New Mexico neighbor in the smuggling operations. In fact, they formed a direct extension of the Colombia-to-Alaska drug conduit. Fish and Game fuzz John Miles, who conducted the search and seizure illegally and without a warrant, and issued the abusive subpoena illegally, and physically assaulted me on my own property, is now head of the agency.

The malicious prosecution was coordinated with the government's investigation of itself in the cattle mutilations, smuggling dope to fund its black operations, and murder of anyone who got in the way, in the Big Lie program, designed to conceal these dark deeds along with flying saucer propulsion secrets, along with activities connected to a secret program involved with the cattle mutilations. The mutilations program collects and analyzes 'specific biological tissue' from mammals—cattle—which are similar enough to humans to yield reliable results in tests of "stealth" particle beam weapons under development, intended for use on humans. This monitoring of the effects of ionizing radiation on cattle, is 'pseudo-justified' to NSA oversight committees, on 'environmental grounds', since the techniques for studying the effects of radiation—whether produced by the high-voltage electrical discharges emitted by saucers, or defense-related weapons under "national security purposes"—are essentially the same.

The weapons appear to be for "population control", judging from the degree of secrecy surrounding the removal of tissue from the cattle. (See Chap. TV ["Sightings"] for more on this subject). The use of other people's animals without their permission helps to conceal the research, since the presence of such large animals at government facilities would be obvious. Since the weapons are designed for use on humans in their natural environment, without their knowledge, use of them on cattle, as the most available mammals around, produces more realistic results. A 'spinof' benefit of the perennial "tests", is to justify the continued veil of secrecy, since, so long as there is "on-going" research involving the saucers, the secrecy conceals them and everything connected to them. Though the government continues to use the national security veil to deny public access to saucer technology, the ultimate purpose is the private, economic security of

IllumiNazi corporations. One fascist hand washes the other, as we are controlled and experimented on like lab animals, and the sham continues.

Back in 1966, during my second semester of law school at U.T., I had discussed saucer propulsion with another law student during a coffee break between classes, within earshot of a student whom I knew to be employed by the CIA. Immediately afterward, in a class of the eminent constitutional law professor, Charles Allen Wright, the CIA/student screamed out, "...What should the penalty be for a law student who disclosed 'national security secrets' in the hallways?", gesturing toward me. Wright screamed, "He didn't disclose national security secrets!"

Around two days later, as I drove south down Red River Street at its intersection with 6th Street, out of the corner of my eye to my left, I spotted a discolored '55 Ford being driven by two Air Force men, parked at the curb near the light. As I entered the intersection, they floor-boarded the Ford, and accelerated directly toward my left door. In a quick reflex, I applied brakes and swerved to my right, just in time to deflect their blow. Both my Chevy station wagon and the Ford were totaled. The Ford had no license plate, and the two men, whose uniforms bore no insignia or other markings, were ticketed for running a red light and causing the collision, and nothing else, although circumstances indicate that they should have been arrested on the spot.

The following day, I discovered that the two airmen were "shipped out" from Bergstrom Air Base, and the Base Commandant's office refused to give me their names or their "newly assigned base". There was no doubt in my mind that they were Air Force "hitters" from the O.S.I. This incident was easy to connect to Air Force spooks, since the men lacked identities, ranks, and addresses, their car was equally anonymous, and the base Advocates office concealed their identities and whereabouts. I could detail a half dozen more such incidents, all of which had similar Kafkaesque qualities which could only be created by a secret police state. This CIA harrasment occurred after they told President Kennedy that I worked for them, and prior to their actual attempts to recruit me. Some of it was meddling in my life by George Bush, prior to his CIA directorship.

Most of the harrasment and malicious prosecution in New Mexico was ostensibly property related. Every property transaction I was involved in since 1970, was intentionally engineered at the outset by the CIA, or screwed up by them. They initially suckered me into coming to Santa Fe in the first place. In 1970, they offered me a seven-acre tract at the junction of Cerrillos Road and Rodeo Road, for a mere \$4300.00, which is now worth millions, and presently includes a business owned by my CIA girlfriend. In 1973, they transferred a beautiful ten-acre parcel on Barrancas Drive to me, filed the deed, and even had it assessed to me. That property is worth at least a million. The transaction was signed by an ex-CIA employee (now a lawyer/banker), a former New Mexico Governor connected to the CIA, and another well-known (also ex-CIA) lawyer. It took me at least four trips to the county assessor's and clerk's offices to convince them the property was not mine. These attempts to give me property by the CIA, were related to attempts to "recruit" me, by indebting me to them, in anticipation of future employment which they intended to provide me, whether I liked it or not.

D.A.s, police, and judges are easily controlled by the N.S.A., and can be made to do anything under the guise of "national security". Even more extreme, I knew that at least two D.A.S, (one in Texas) were employees of the CIA, because one was involved in attempting to recruit me directly, and the other I won't say how I know. One judge inadvertently disclosed to me that the N.S.A. was influencing the case before him, in which I was involved, in his ruminations from the bench,

mumbling that I was supposed to be "...some sort of 'rocket scientist' or something...", which the government wished to control. That was because the particular orders given to him came from security people connected ostensibly to rocketry, but were actually concerned about flying saucers. That judge was a close personal friend to a man I refer to as the "Friend", about whom I will say more later. We don't control these people. They operate on their own, inside our government, representing the Trilateralists, not us.

For around ten years, I was grilled by northern New Mexico's "Torquemada", (a Santa Fe judge). There, sitting in judgment of me, was a psychologically tormented, insecure "momma's boy" from Espanola—an 'ex-pornographer' who was addicted to cocaine—who for the sake of his co-addict/sadist legal colleagues, took every opportunity to pretend to impeach my credibility, or make underhanded swipes at my character, which were really none of his business.

When I first moved to New Mexico, I was a sculptor and a painter. I had already undergone a horrible incident at the University of Texas, instigated by Jesuit-controlled agents of Dr. John ("Long John") Silber, which eventually resulted in his being fired by Frank Erwin, President of the Board of Regents, for FRAUD AND CONSPIRACY, and the revocation of the PhD. of L.B.J.'s Undersecretary of Health, Education and Welfare, Dr. Billy McCrocklin, for plagiarizing his doctoral thesis from a 1920s top secret document on the Garde d'Haiti called "The Hart Report". These were not retributions by me, but the result of anger by others over the things being done to me, which tripped certain levers leading to the undoing of an evil perpetrator, taking a few others with him.

Some of you may have heard of Dr. John ("Long John") Silber, the Dr. Strangelove-type president of Jesuit-run Boston College, who ran for governor of Massachusetts and lost in 1993. He is a rigid, dyed-in-the wool classicist/fascist, with a potential to create great mischief. He left the University of Texas after I uncovered his conspiracy, because he sent a cabal of his "hatchet-women" after me. He dragged some of them on up to Boston with him, because they were being run out of Texas too. The incident was similar to one involving John Henry Faulk, with the exception that there probably never will be any attempt to redress what happened to me. What brought the harrassment temporarily to an end, was the blowing of the cover of several CIA operations on the University of Texas campus, which resulted from some of those angered and set into motion over what was happening to me. Sometimes you never realize who your friends are until the chips are down.

I once mentioned to a CIA man whom I respected, that it appeared that the agency could be harrassing someone at the same time another group from the agency was trying to do them a favor, or gain their cooperation. He explained it to me like this: Every organization has its right wing and its left wing, each of which does not seem to know what the other is doing.

Though I graduated with what my friend Henry said was the highest grade-point average of any fine arts graduate student in the history of the University of Texas, that incident had dragged me through the mud as it was designed to do, and had taken a lot out of me already.

The seventeen years of New Mexico judicial harassment just about stamped out all of the art in me. An artist cannot work under conditions of "judicial war psychosis". There are two horrible aspects involved here, which are: (1) The government's policy of secretly violating freedom of speech and press; and (2) clandestinely carrying out this policy through obedient government yeggs and dupes, each motivated at his or her own level (and who often don't even know who is

calling the shots). The victim has no way of proving the illegal motives or even the existence of the conspiracy, because of the phony "national security" veil.

I turned away a large fortune rather than become beholden to the CIA. After all the abusive litigation, I concluded that so-called "justice" and "freedom" in America are terms used on the naive and ignorant, to give them the false impression that they are the fortunate recipients of "rights", which in reality exist only for so long as their individual interests don't conflict with those of the Trilateral Commission. I now realize what a wealthy young man was trying to tell me in 1968, when he said "...property is just a trap". I thought he was some kind of Communist or something, who didn't believe in property rights. I didn't own any real estate then, but thought I'd like to have some. I now realize that what he meant was that a person who owns property can be controlled by threats against the ownership of that property by the state, or indirectly through others encouraged by the state. He helped organize the Washington Monument demonstrations in the late '60s, to bring the Viet Nam War to an end. Though a multi-millionaire, he refused to own property. The F.B.I. probably didn't even know who he was.

The last six years of horrible controversy which diminished in 1992, involved motivating some of my thug neighbors to sue me, as others continued to abuse me while the litigation progressed in court. As I struggled in vain to hold my family together amidst the stress of litigation and social ostracism created by the criminals behind it and in the courts, they moved in for the kill and destroyed my family. Causing my loved ones to suffer is a "blood crime", if you get my meaning, and it won't go unpunished. I'm part Kiowa, Cree, Cherokee and Natchez—as well as Highland Scottish—so I know how to play the "waiting game". I'm incredibly patient.

I MEET A MEMBER OF THE TRILATERAL COMMISSION'S INTERNATIONAL GEODETIC SURVEY TEAM

This region is quite a crossroad of America, including many Trilateral Commission connections. A friend of mine was one of the surveyors for the International Geodetic Survey, in the 1950s, during the Korean War. The survey was international, which meant that the supposedly civilian American scientific crews, with American military escorts, were allowed into China, the Soviet Union, etc., even during the war. My friend was a surveyor in the American military, as was the entire survey crew he worked with. The scientific crew was civilian. However, according to my friend, they switched clothing, so that the military survey crew looked like civilians, and vice-versa. The civilian-dressed (military) survey crew, would determine the location of each of the points, to be marked by the I.G.S. brasscaps, and were instructed to remove themselves from the area, after which the (military-dressed) civilian crew would then come to place the brass-caps.

One day, after locating a point, my friend left the area, then discovered that he had forgotten some of his equipment, and went back to get it. At that time, he came upon the other crew, while they were supposedly in the process of setting the I.G.S. brass-cap. This came as a surprise to them, because they were actually placing a device underneath where the I.G.S. brass-cap was to be placed. This "sub point" was marked with the insignia of the Trilateral Commission, which was a triangle with a dot in the center, just as I had seen on the old Pojoaque viejo's work box from the "p2" 1937 Los Alamos project. The civilians (dressed as military) were very angry at him for having disobeyed instructions, especially in view of the fact that he had seen the concealed device being set into cement, beneath the surface, above which the I.G.S. brass-cap was to be placed.

The secret point, marked by the Trilateral pyramid with a dot in the center (the Masonic/Egyptian "all-seeing eye of Bel, God, or Ra" as shown on the dollar bill), identified the "Illuminati" as the controlling, so-called "civilian" parties of the I.G.S.

Each of the secret geodetic points on our globe, placed at the vertices of geodetic triangles dividing our planet's surface, apparently contains a crystal resonator set to respond to a distinct frequency, for navigating flying saucers (even unmanned ones), and even rockets, either manually, electronically, or by computer. Flying saucers can travel at least 9,000 m.p.h. At that speed—given other limitations on visibility—the resonators provide a means for computer navigation of saucers at high speeds, without visibility, and allow for accurately determining global locations. As a means for Secret Government world navigation, the I.G.S. markers have been in place for forty years. Without the means for using them in 1950, they would have been useless. This survey, actually done for the Trilateralist world government, under the "cover" of the I.G.S.—right under the noses of the United Nations teams, military authorities, international committees, survey teams, and host countries—showed the awesome power of these world-wide conspirators, whose actions violated the sovereignty of nations, through the United Nations.

This "geodetic navigation system" was a perfect solution for the flying saucer and for the Illuminati and Trilateral Commission, since it automatically involved triangular global areas generated by the "great circles" of the "master builder", according to the Genesis passages relied upon in the "secret work" of the "Old Prussian" Masonic Lodges based on the Johanite Gospel, the membership of which excluded Jews, and were forbidden to belong to "humanitarian" Masonry. The teachings of this Johanite German Freemasonry included a dogmatic Christianity, and is rooted in the same, weird teachings of the former Jesuit priest and founder of the "modern" Illuminati in Bavaria, Adam Weishaupt. Out of this sprung the Thule Society and the Ahnenerbe Society, which figured strongly in the S.S., among whose founders was General Karl Haushofer, the originator of the modern "science" utilized by "our" CIA, called "Geopolitics". The following three archival emblems show the transition from the Thule Society, the Deutsche Antarktische Expedition (the German Arctic Expedition, with swastika and oak leaves showing Thule Society sponsorship), the "globally conscious" I.G.S. Survey, ala Haushofer's "geopolitics", to the UN:



The several special multidisciplinary, integrated disciplines developed by the SS inner circle, as part of a plan of future world government, included Geopolitics—combined politics and geography—including the ethnic studies and 'racial science' of the Ahnenerbe, linguistics, and culture—and Parapsychology—combined religion and psychology—for use in the MASS PSYCHOLOGY BIG LIE system. Parapsychology would assist the 'geopoliticians' in maintaining mind control of particular populations, creating psychological conditioning conducive to unquestioned obedience to faceless authority. This system was ordered by John D. Rockefeller in 1923, when his people trained the SS and chose Hitler as the future leader of the Third Reich, as R & D for the future mass-psychological control technology, now applied in America since 1945.

In 1957, as a member of the Air Force—like all American armed forces managed according to the Sturm Abteilung ("Storm Division") Nazi troop management manual written by the 'synergist', Ernst Roehm, homosexual 'father' of Hitler's SA—I was assigned to Operations Intelligence, working in an 'SS library' as a monitor. I often heard the term "geopolitics", and logged various documents and books into and out of that library. I was literally surrounded and controlled by the trappings of the Nazis which had impressed our leaders so much that they officially 'adopted' them. The library was the creation of the Nazi intelligence network, the photos in the documents and books dating from that period and bearing overwritten German file indexes. There was practically no way for the U.S. government to have obtained such a 'library', other than from the files compiled during the Nazi invasion of Russia

At the time of the German 'surrender', American authorities were deeply impressed with these materials, so thoroughly accumulated, catalogued, and organized by Reinhard Gehlen's SS group, which included the monsters Heinrich Mueller and Reinhard Heydrich, that the CIA actually hired them in the U.S. under assumed names¹. These files were used by the SS in the death camps and in sifting through the various Slavic "slave peoples" of the Soviet Union, to ferret out and murder Soviet Jewry, Gypsies, and others deemed "inferior". The documents acquired an ostensible 'new' purpose as barter and trade to an America which allowed itself to be drawn into a Cold War based on the dubious urgings of the Organization Gehlen's "experts", the new CIA's Soviet 'analysts' and 'specialists'—former SS intelligence officers—who convinced us that the Soviets were planning to attack us at any moment. We in SAC Intelligence could load the library into "mobility boxes" on a moment's notice, to take with us to a remote staging area nearer to the Soviet borders, in the event of the outbreak of war. But only after an invasion of the Soviet Union by us as conquerors, would the library assume its actual function because, other than the ostensible purely academic use as an 'invaluable reference library', it still retained its true identity...as a reference to be used in the systematic subjugation of foreign peoples by Nazi conquerors.

Almost a month before the fall of the Berlin Fuehrerbunker, Gehlen was already deeply bartering with selling American intelligence on the value of his organization, primarily on the basis of its contacts in and expertise on the Soviet Union. In retrospect, it appears that the long-range plan of the SS officers of Gehlen's organization was to get Hitler's revenge against "Judaized America", by offering themselves to us as "intelligence experts" at a hefty profit, allowing them to survive intact as a secret sect within the secret core of our 'intelligence community', while embroiling us in a tortuous Cold War which lasted for almost fifty years.

¹Gregory Douglas, Gestapo Chief (three vols.), R. James Bender, P.O. Box 23456, San Jose, Ca 95153.

CHAPTER III: I MEET A GOVERNMENT M.I.B. IN SANTA FE; HOLLYWOOD ON THE TAKE

The magnitude by which electricity overcomes the force of gravity, is rivaled only by the magnitude by which the Big Lies of our government and the Trilateralists have overcome our rationality. These IllumiNazi Big Lies about "aliens" are disseminated through all the mass media. Someday there should be justice by public trial and punishment of the traitors who have perverted the instruments of democracy, and are entitled to none of our protections, which they seek to destroy. They who have made war on our Bill of Rights and Constitution should have to defend themselves without their protections.

Without our consent, the Secret Government is consciously waging psychological warfare against us, in violation of our right to government only by our consent. They use movies, T.V., books, magazines, advertising, children's stories, and all forms of propaganda, from the cradle to the grave, to criminally undermine and subvert the epistemological underpinnings of rational existence. We have not 'consented' to a fraud of which we are unaware. Our government, on behalf of the TC/CFR, has created the whole "alien" scenario, to brainwash us. So what is their purpose? To conceal flying saucer technology from us, and to stretch our credulities so we will believe the Big Lies. Control is the name of the game, and they have it. Flying saucer technology would break that control, so we don't have it. Are we a nation of wimps who will do nothing about it?

According to one nutty writer¹, the purpose is either to fabricate a phony alien threat, so as to unite the world under a one-world fascist/socialist TC/CFR/Bilderberger/Illuminati dictatorship, or to render the world's people into subservience to actual aliens with whom they have cut a deal, and he thinks it is all the fault of the Masons.

Unfortunately, neither of these conclusions is correct, though the first one contains a germ of truth, in the fabrication of a phony alien threat, but in view of the two purposes I stated above, this wacky theory is perceived as just as misinformational as the crap emitted by the CIA's or O.N.I.'s covert agents in UFOlogy. The phony 'alien' threat was derived from a public speech by Ronald Reagan regarding the effects of an hypothetical alien threat, which in a paranoid's mind, is the kind of hype to be used to appeal to a bewildered constituency, so they can be unwittingly used to spread the dumb idea that the alien propaganda is intended to scare us into the arms of the NWO, or is a leak from the inside regarding a deal the government has with the aliens.

Such wacky propaganda is induced by a shell game: "Will those who have lost track of the real issue please raise their hands." The real issue is saucer technology. The controllers get their control over us with our money. The TC/CFR bunch have exclusive control over the saucer, since it is the most perfect instrument for 'world surveillance', and because its availability to the public would eventually destroy the economic power they now wield over us, through their control over energy, transportation and communications resources which we pay them for every day, so we "can't have it".

The plan will work only if they can maintain this exclusivity, which can only be maintained through continued ultra-secrecy and the help of dupes, and anyone else

¹Milton William Cooper, Behold a Pale Horse, Light Technology Publishing.

stupid enough to believe the CIA UFOlogists, in spreading the misinformation of alien origins of saucer technology. Since saucer construction is rather easy to duplicate, once the simple principles are known, even the scantiest secrets related to it are protected. That is the reason there has been no open saucer usage in any of our wars since 1945, even though this would have guaranteed clean and complete victories and prevented further loss of American lives. These facts show the ultimate treason through which these people have abused us, the 'paying' and purported 'owning' parties, while the CRF/TC enjoy exclusive use of 'our' saucers as 'their' special tools.

The second idea, that our government may have cut a deal with "aliens", was just plumb dumb. It was so dumb, that William Cooper, one of those who adopted this story, changed his tune the moment he bought a copy of my first edition, with the idea that he could abandon his old stuff and take credit for my claim of "exclusively human origin", so long as he never cited my book or told anyone that I had 'converted' him to the idea, but people noticed anyway, drat it! But Cooper still doesn't get it.

The manipulators of the TC/CFR have the mentalities of sociopathic ants. Their whole method was copied, then cynically perverted from an original idea of Nikola Tesla, before the ultimate destruction of the League of Nations, eventually brought about by Cecil Rhodes' British Round Table Group, and its American branch, which fused in 1919 into the new international British-American organization, known in America as the CFR ("Council on Foreign Relations"), and in Britain as the I.I.A. ("Institute for International Affairs"). Tesla had naively offered his flying saucer invention to the Geneva Convention and League of Nations, as an ultimate 'police vehicle' with which to patrol the world to maintain peace. His dislike of the new British-American organization was reflected by his disillusionment when the League of Nations was emasculated by the new group.

Meanwhile, the CFR/IIA was stealing his greatest invention, for its own exclusive use in the inobsequious world dictatorship we now have, using covert manipulation by war. Rather than maintaining peace, the war profiteers create the divide-and-conquer conditions leading to wars, profiting by them, then use the resultant wars, surrenders and 'peace negotiations' as pretexts to constantly restructure the world, profiting by them. The man who stabbed Tesla in the back, then twisted the hilt, was none other than J.P. Morgan, a member of the CFR, who was already a dictator of American energy and communications. Morgan suckered Tesla in, in a most treacherous and sadistic manner, seeking to completely crush him emotionally, driving him into a psychological turmoil and destitution from which he was never intended to return.

The TC/CFR/IIA like things just the way they have them, don't want to rock the boat, and fear most of all, significant change, since fluxing of conditions could induce unpredictable widespread free communications, which could awaken the people to the scam. That is the reason they sought to shut down the computer Internet in 1995. When they control the purse strings of the world, and soak up all the revenues of the people of America just to pay the interest on our 'national debt', why would they want an obvious 'world dictatorship', which would kill the goose that laid the golden egg? So long as we slaves keep our noses to the grindstones, they have it made. The only thing which would induce them to take drastic action, would be if the public suddenly becomes aware of the Big Picture. They won't create tumultuous conditions which they can't control, and anything 'spontaneous' must be brought under control to the ends they desire. That is the reason the TC/CFR media have taken unfair advantage of the Oklahoma bombing of

Apr. 19, 1995, by misdirecting the public outrage over the bombing, from those responsible, to the grass roots sovereignty movement, militia movement, constitutionalists, and in general, all those who are critical of the government, know about the Banksters, have documentation to prove it, and are awakening the rest of the people to the total abnegation of American sovereignty by these worldists.

Though the Bilderberg group's public emergence can be traced to 1952, its name supposedly derived from the place of their supposed "first meeting" at the Bilderberg Hotel in Holland in 1954. This group has a much older, but perhaps not so clear, origin. "Bilderberger" is a German word meaning "picture merchant", denoting the internationalists who have for centuries used paintings and art as a store of wealth, as a hedge against inflation, and as a compact means of transportation of their wealth from one country to the other. That is the reason so many unscrupulous and ruthless people, such as Armand Hammer, have had so much of their wealth tied up in valuable paintings and other art. And that is where the famous Dutch Hotel got its name, since these people came so often to Holland to conceal the loot which they as dictators or just plain high-placed thieves, had accumulated in the countries which they had so often throughout history, stripped of wealth.

For centuries, Holland was the place to discretely buy and sell valuable pieces of art, and to convert them into and out of the various currencies of the world at current values, avoiding inflation, taxes and prying eyes. The Dutch, like the Swiss and their banking interests, have always been accommodating, and named a hotel after their infamous guests, many years before the formal meeting in 1954. I first heard about the Bilderbergers in 1960, from a person who had known about them since before the depression. I once knew an old Dutchman who as a boy at the turn of the century, acted as an inconspicuous, secret courier, riding his bicycle, carrying various currencies for the Bilderbergers from country to country in the lowlands, usually at night, until he received a serious, life-long injury when he was run over by a coach one rainy dark night.

The TC/CFR/Secret Government, has consistently used the mass media to convince us that flying saucers are from outer space, rather than being man-made, and to my knowledge, this is the first book or any other media production, which makes the unequivocal, categorical assertion that they are exclusively man-made, and that NO EVIDENCE EXISTS ON EARTH OF ANYTHING EVER BEING "MADE" EXCEPT BY HUMAN BEINGS.

If anyone believes that the use of mass media for such purposes is just "harmless entertainment", they should have watched the two-part miniseries, Intruders, aired by C.B.S. on May 17 and 19, 1992. The scenario left no doubt that the intent was to beg the question that flying saucers are "extraterrestrial spacecraft", to intimidate and threaten us, and to falsely convince us of the following ominous things:

OSTENSIBLE MESSAGE: (a) That aliens are "with us";
(b) that our government "knows it";
(c) that the government's policy of secrecy is "for our own good" and "justified";
(d) that the government will hurt you if you don't comply;
(e) that anyone who actively resists, will commit "professional suicide", or worse.

ULTERIOR MESSAGE That man does not possess this
(simple) technology.

If anyone has any doubts as to the CIA's harrassment of independent flying saucer investigators, the following facsimile clipping regards oppression of them by the CIA;

UFO congress hears claims against CIA

ACAPULCO, Mexico (UPI) - William Spaulding, director of Ground Saucer Watch Inc., claims the CIA has been interfering with unidentified flying object watchers.

He told the International Congress on UFO Phenomena in Acapulco Thursday the CIA has recommended that groups of UFO researchers be watched during sightings and "considered as subversive."

He charged the agency's domestic operations have "harassed and intimidated researchers and tried to hold up the dissemination of UFO information."

Spaulding's view is challenged by former CIA agent Bradley Ayers, now a registered private detective in Minnesota and UFO researcher.

"The agency has been made the whipping boy for all the ills of the world", he said.

"LOOKING FOR MOTIVES"

We can use the CIA's own analytical techniques against it. The gist of the government's primary motivations can be reduced to protecting the corporate-state interests, by concealing the Secret Government's flying saucer surveillance of us, and the elite's energy, technological, and transportation cartel. The rest of the garbage is merely a "means to an end". Through false propaganda rumors about "extraterrestrials", they have duped support for their policy, based on the false premise that the "end" (prevention of widespread panic over the fictitious "alien presence") justifies the "means" (government mass-media brainwashing and intimidation of men, women, and children), while on the 'public' level, a phony alien threat is "implied" by the media, and used to psychologically intimidate reticence to the TC/CFR Illuminati leadership. Once we recognize the FACTS that THERE ARE NO ALIENS ON EARTH, and that THE GOVERNMENT AND THE TRILATERALISTS HAVE CREATED THE ALIEN MYTHOLOGY to conceal FLYING SAUCER SECRETS intended for EXCLUSIVE USE AGAINST US WITHOUT OUR KNOWLEDGE, it naturally follows that public access to flying saucer technology, conceived by an American citizen over NINETY

YEARS AGO, will remove the PRIMARY motivational basis for the world corporate-state conspiracy, and destroy their BIG LIE PROPAGANDA SYSTEM.

In examining these hoaxes, one cannot fail to see a connection to the ancient Sumerians, Egyptians, and their worship of Osiris, as well as other ancient esoteric suggestions, which is because the Nazi intelligence planners in the CIA are fond of such esoterica. In my chapters III and VI, I give you some of the mythological foundations for this religion, which is over 6,000 years old. The Egyptians, who did not originate this belief system, which came from Asia, used a whole system of myths to control everything, just as the Illuminati does today. This has been a role model for totalitarian designers throughout history. The Egyptians' 'enemies'—the Sea Peoples, Assyrians, Babylonians, Amorites, Sumerians, Akkadians, Chaldeans, Greeks, etc.—shared this same ancient nature religion, and could be 'spiritually' manipulated by Egypt, which practiced the religion in its most highly classicized form, the Mecca of sun worship, just as Rome became the home of the Roman Catholic Church. This is the "secret of the ages": Mysticism! Those who can be suckered in by it, are putty in the mystics' hands, the hands of those who only use mysticism as a means of control. And those who resist, can be killed by those who follow, all in the name of "God", "Ra", "Mohammed", "Stalin", "The Fatherland", etc. Marx stated that "religion is the opiate of the people", but he failed to point out that he also was a religious mystic, who asked his followers to believe in the "mystical power" of THE COLLECTIVE, on faith rather than reason. I would further define "mystics", as those who seek to gain values from others, or to deny others the use of their own minds as individuals, on the basis of "special powers" which can't be proven and must be accepted on "faith", so as to control them. This always involves some form of mysticism, as any con-artist could tell you. And the bottom line is, THERE ARE NO MYSTICAL SECRETS!

Socialism, Communism, Fascism and Naziism are inventions of the IUuminati, theo-statist "masks", which make the citizens pay for their own bureaucratic enslavement and "social and economic benefits", while the elite remain in secret control of the world, increasing and using their illicitly gained profit and power for themselves, without bearing any responsibility for the wrongs they inflict, since the guilt for this is thereby scapegoated to the citizens and their puppetized 'leaders'. Karl Marx and the IUuminati which backed him, took the Judeo-Christian "you-are-your-brother's-keeper" conscience, and perverted it into a "statist conscience", under a "state religion" with moral and physical damnation of non-believers ("heretics"), while the people shared the poverty, false guilt and weakness thus created.

CORNY GOVERNMENT SPECIAL EFFECTS AND HOAX SCENARIOS:

The Roswell Rhesus Monkey Hoax and Other Such Outrageous Shams

In the late '40s, when Hollywood's emerging "space age" special effects were funky and humorous by today's standards, the special effects of the personnel of Holloman A.F.B. at Alamogordo, White Sands Missile Range, and Walker Air Force Base at Roswell, were even funkier. They executed the stupid 1947 hoax which is sometimes called the "MJ-12" incident or "The Roswell Incident", but which I call "The Roswell Rhesus Monkey Hoax". Until 1952, Wernher von Braun was working at Ft. Bliss (as Director of Research, U.S. Army Ordnance Guided Missile Command), from which post he continued to conduct V-2 (A-9, V-6, V-7) tests at nearby White Sands

Proving Grounds, while other tests were being conducted on the rocket sled at Alamogordo, using rhesus monkeys in G-suits, to determine the limits of human G-force endurance and other problems of high performance flight in conventional high performance aircraft (necessary to sustain conventional aeronautics on a high level in order to stave off demands for the saucer technology in national security groups). In 1952, the researchers switched to chimpanzees in A-9 tests. The chimps were much easier to control and less dangerous and problematic for personnel to handle.

In the original 1947 hoax, a small, comic-strip-type flying saucer—around twelve feet in diameter, constructed of stock sheet aluminum, rivets, screws, bar stock and molding, with a plastic "bubble-canopy" for the 'pilot', and an old automotive antenna with a ball on its tip projecting from the top of the bubble—was placed in a spot about four miles from Walker A.F.B., on the ranch of a cooperating co-conspirator. Four rhesus monkeys, which had been shaved, dyed green, and outfitted with corny little "space suits", complete with little 'space' helmets, were strewn near the fake saucer. News leaks were arranged by the intelligence "E. & D" (Evaluation and Dissemination) Officer, as the 'crashed alien flying saucer' and the four 'space aliens' were 'found' by the military authorities. Just like in a third-grade play, only this scenario was worse. Just imagine "Peter Pan" being performed by a bunch of G.I.s.

The Alamogordo intelligence personnel even purchased the green pigment—dry tempera pigment—from our family business, and I even showed them how to apply it by rubbing it on dry, just like on "limed oak" furniture I showed people how to finish. Our business was the best art supply, decorating and paint contracting business in the region, and Alamogordo had none. My father and I even decorated the new house of Robert O. Anderson, in Hondo (near Roswell) about 1951.

By our present standards, the mock flying saucer was a grossly amateurish attempt to foist a corny hoax upon the public. 'Leaks' to the news media, including a few ridiculous photos of the saucer (which would have been prohibited if the events were true), and the dead monkeys in the corny 'space suits' (the monkey-sized G-suits used in the acceleration experiments), were publicized in newspapers, and eventually found their way to magazines, despite the immediate attempts by the startled and angered Pentagon officials to retrieve all the evidence. The whole confused scenario and withdrawn publishings, created even more weirdness. One of the P.I.O.s (Public Information Officers) of Army Air Corps Intelligence, Walther Haut, sent out the initial press releases to area newspapers, announcing the recovery of an "alien flying saucer", including 8" x 10" black and white glossies, showing the 'captured' saucer and 'aliens'. Haut, who now runs a "Flying Saucer Museum" in Roswell, New Mexico, has made no references to those photos in any of his recent statements. That is because he was then, and still is, an employee of the intelligence community. Fortunately for the Pentagon, the photos were sent only to regional, small-town letterpress newspapers, few of which possessed the means to reproduce the photos in 1947, without first having half-tone photo-engravings produced in larger cities. This gave the Pentagon more time to get most of them back before publication, or to stop the papers before they were distributed. In preparing for the hoax, regional military intelligence personnel had created a 'crash site' with a bull dozer, on the rancher's property, by making a huge gash in the ground. Whoever was handling the dozer that day was a bit heavy-handed. The 'saucer' however, was obviously a stupid hoax, as there was no way that the flimsy little craft, without a dent or hole in it, could have plowed such a gaping hole in the hard and rocky,

sun-baked desert ground. The photos of the 12-foot diameter fake saucer had become known to many people, yet today, I seem to be the only person who recalls them. Since the initial photos—already prepared before the crash—were issued immediately after the purported 'crash', personnel had insufficient time to fabricate the fake saucer afterward, so the initial photos from the Army Air Corps, of the original fake saucer, without a speck of dust or a dent on it, represented physical evidence of the hoax perpetrated by them. Further proof that the photos were taken before the hoax was executed was the fact that the junky little saucer was photographed in a hanger (at Walker or Holloman), while the "aliens" (i.e., rhesus monkeys, completely dressed in their G-suits), were photographed in an Air Force laboratory, not at the hospital, most probably at Holloman A.F.B. at Alamogordo. That was prior to their removal to the hoax site, thence to the infirmary at Roswell. After the hoax, the G-suits were removed for 'medical' purposes, except for a couple of the monkeys, which were raising a horrible stench, because they had relieved their bowels in the G-suits, upon death days before, and the hot desert sun had accelerated the fermentation of the monkey excreta and corpses, after their removal from the morgue at Holloman.

Years later, a photo of a supposedly operational, 60-foot diameter, jet-powered saucer designed by Schriever in WWII Germany, was leaked, but that scenario was withdrawn, since it verified a German saucer program, although a disinformational branch intended to hide the true electrically-powered project at Peenemunde. The initial evidence which reached certain members of the public, had already revealed the initial hoax to intelligent but somewhat confused witnesses. The latter leaked photo showing the Nazi saucer designed by Schriever, made in Czechoslovakia during the war, part of the saucer stuff rounded up by General Patton and transported to New Mexico along with the rest of the German saucer projects, around September, 1945, under Operation Paperclip. Since it wasn't one of the highly classified "electro-saucers", the photo did little harm, and had a 'professionally constructed' appearance, intended to overcome the poor craftsmanship and design of the fake saucer. It was a 'withdrawn hoax', however, since it tended to acknowledge a crash which conflicted with the later "weather balloon hoax" concocted by the Pentagon to conceal the first bungled hoax.

Because of all the gross stupidities and miscalculations on the part of the initial huxters, the initial scenario was obliterated by subsequent weather balloon stuff which was only slightly less stupid, but the initial 1947 hoax, 38 years before the third, 1985 "MJ-12" hoax, still contained 'salvageable parts' as far as the Pentagon huxters were concerned. The Pentagon team had taken great pains to carefully obliterate and omit the dumb photos of the original saucer and monkeys, which clearly smells of a Pentagon "cover-up" of its hoax, while, the public, most of whom never saw the photos, failed to realize that what was being "covered up" was not an "alien crash", but an unauthorized 'wildcat' hoax, not cleared through the Pentagon, created by ex-Nazi military 'intelligence' personnel, which was bungled by lack of special effects expertise.

The 'salvageable' parts of the first hoax, which provided the precedent of a mystified 'alien saucer' incident, together with the 'government cover-up', were reborn as a third, MJ-12 hoax, complete with a set of fake, newly created and planted 'presidential orders', obtained through the "freedom of information act" This new scenario was written by a team of Ph.D.s, submitted to a secret committee, and approved by them. Even so, that scenario has been called a hoax by the government itself, since it also conflicted with the second, "weather balloon hoax", which has now become the

"official" position, because government officials are absolutely forbidden to acknowledge the existence of flying saucers, be they fake 'alien' ones, or real, 'man-made' ones. In order for the government to drop back to the second hoax, it was necessary for them to admit that the third, MJ-12 hoax, was a hoax. It took them some time to realize that the second hoax was better, because it allowed them to simply deny questions about 'aliens' which did not in reality exist. Also, it was necessary to insure, through their control of UFOlogy groups, that only the 'right' (i.e., "wrong") questions were asked in the petition now known as "The Roswell Statement".

It would seem that, with the 38-year lapse between the first and second hoax, they could have done a better job, but alas, the government bunglers screwed up again. The error involved slander and fraud against deceased presidents Truman and Eisenhower, by forging their names on false documents which alleged an incident which never occurred. Such fraud and slander should not have been treated so lightly by law enforcement authorities in respect to the arrogant Pentagon officials, who clearly overstepped their authority, by falsifying actions taken by former (deceased) commanders-in-chief, ex post facto.

At the time of my 1993 first edition I was unaware that the original photos had become completely 'unavailable'. Though I was unable to find my copies of them to include in this book, I assumed they were known to the usual saucer investigator, and proceeded to point out facts which I thought would be obvious to anyone examining them. Then I was astounded in late 1993, to discover that no 'civilians' involved in UFOlogy knew of or said a thing about the old photos. I knew that I hadn't seen the two photos, given to me in 1970 by a newsman, or my magazine showing the photos, since 1974. These stupid photos infuriated Pentagon officials, by revealing the identities of the "aliens" as shaved rhesus monkeys, in a hoax which was an amateurish attempt to convince the public that the German flying saucers seen by so many people in the area, were "extraterrestrial". The Pentagon would never have approved the hoax beforehand, and the original hoax, as perpetrated, would never have held up, because it was too amateurishly funny!

What the photos showed, as purported "space aliens", were shaved rhesus monkeys, wearing monkey-sized, machine-sewn, G-suits with the pressure lines and lacings, equipped with oxygen tubes, helmets, and other equipment, identical to those of the X-15 rocket plane test pilots, for whose benefits the monkey tests were conducted, to accumulate data from rocket sled tests at Alamogordo, on the outer parameters of G-forces which humans could withstand. The helmets concealed the small sizes of the upper craniums of the monkeys, later exaggerated in the "official standard alien" model.

In view of the original hoax, the MJ-12 documents were apparently intended to retroactively convince us that "space aliens" from millions of light years away, possessing 'superior intelligence', had come to Roswell. It was contemplated that the public could still be convinced of this, provided the scenario was presented without the photos, which by the poor judgment of the 1947 military intelligence personnel were considered "convincing". The third-rate 'saucer kitsch'—the rhesus monkeys in G-suits, and the junky little saucer of such poor craftsmanship that a California hot-rodder would have been ashamed—had to be concealed. The recently fabricated 'presidential orders' of "MJ-12" were intended to resuscitate the original "aliens"—minus the dumb photos—despite the obvious fact that beings of sufficiently high intelligence would never have contacted jerks at Roswell or Alamogordo, or even Area 51, unless there was

a reasonably expectable opportunity to contact the most powerful political leader in the world, and even an idiot wouldn't make that mistake! The sites didn't even vaguely resemble Washington, D.C. or New York City. Government-employed writers have attempted to fabricate several "secret meetings" between various presidents of the U.S., as a basis for hoax scenarios, when an examination of the presidential calendars and newspapers on the alleged dates, shows that the presidents in question were involved in other activities which precluded the authenticity of the documents. There is now the original "rhesus monkey" hoax, the "weather balloon" cover-up hoax, and the "MJ-12" hoax, all now being played upon by the O.S.I. "UFOlogy" and government "denier" symphony, which can buy time indefinitely, so long as the phony debate is protracted.

I taught art at White Sands Missile Range School, in 1970-71, and I can assure you that there was no reason to believe that space aliens of superior intelligence would have passed up New York City and all the other metropolitan cities of the world, and instead, have landed near Alamogordo or Roswell. I have also worked in the movie industry, and can assure you that these efforts were grossly incompetent! Poor props, poor sets, poor makeup, poor acting, poor script, and poor production. Worse than Radar Men From the Moon. I also believe the hoax was cooked up by ex-Nazi Holloman intelligence personnel, rather than Walker or White Sands personnel, because the monkeys were used there, the saucers were used there, and because Walker, as the "fall guy" base for the hoax, would create a distraction from the real perpetrators. Walker was a basic flight training base, with a few old bombers from an old atomic bomb wing (which at one time possibly included the Enola Gay, if my recollection is correct), mothballed there after the war, until the base was closed down sometime in the late '50s or early '60s. Holloman, an advanced flight-test base which also defended the whole top secret area with a fighter-interceptor group, performed highly classified tests in conjunction with White Sands Missile Range, and in respect to Wernher von Braun's intended manned (rocket) moon missions, which were probably shams to cover an earlier mission in the electro-propulsive Graf Zeppelin. Data produced at Alamogordo was used in the design of future rocket planes, jet fighters and bombers, flying saucers, and eventually, stealth planes (very expensive shams to cover saucer stuff).

Another reason the MJ-12 hoax related back to the old rhesus monkey hoax, was to utilize the weird 1947 image of the shaved monkeys, which had become the 'official standard alien model' approved by the secret committees, to be useful in back-dating the more recent plans of extended fraud. The monkeys, with their large, glassy, slanted eyes, small chins and mouths, and skinny bodies, are close enough to "E.T." to make a stab at it, at least in the retarded minds of the government plagiarists, and if need be, could be faked by small human actors, even child actors, midgets, or small, skinny women actors, in space suits, wearing latex masks with sunglass-lens eyes. The dark lenses conceal the human eyes, and create an eerie effect. The more recent wave of "alien" movies from Hollywood—many having nothing to do with this hoax—seem to have given the huxters a new life, by providing a body of more recent movies from which to plagiarize and sponge new 'spin-off hoaxes. There are also now many more competent special effects, prop-building, and makeup technicians available within the intelligence community.

Government agents posing as concerned citizen "UFOlogists"—also mimicked by unwitting dupes falsely induced by them—recently have naively revived this old incident, alleging that a "government cover-up" in 1947, concealed "evidence of aliens from space", and secret collaboration between them and our 'brilliant' military

authorities and government. If that were true, they certainly didn't do a very good job of it! Even if genuine, the MJ-12 presidential documents could not have been obtained through the freedom of information act. Government agents ("UFOlogists") have agonizingly gone through the whole "Freedom Of Information Act" act, to obtain these "secret documents", for use in their propaganda war against us; warmed over hash, four times over. That's supposed to make this sham more believable?

The fake MJ-12 documents were intentionally ambiguous, since the embarrassingly stupid photos may still pop up. They have protected their flanks by ambivalent statements, intended to plant more seeds of doubt, to stretch the credulity and 'open the minds' of the gullible, to wallow holes in their credibilities large enough to cram the most recently approved official versions of the BIG LIES into. I lived just to the south of Roswell in 1947, and picked up the truth by "social osmosis". Three of the dead rhesus monkeys had been stored in a morgue at Holloman, after being killed in acceleration experiments on the rocket sled. The fourth monkey was almost dead, and so was included with the three other dead ones used in the hoax.

To make my 'social osmosis' more complete, the story that the "aliens" were shaved and dyed rhesus monkeys in G-suits, originally came to me through family connections, since my brother-in-law's aunt was the "nurse who later became a nun". As a nurse, she was present during the alleged "autopsy" (actually a dissection). Being a U.S. Army nurse who was a New Mexico survivor of the Bataan Death March, she easily recognized the rhesus monkeys, since she had been forced by the Japanese to cook and eat rhesus monkeys for food in the Bataan Peninsula. Leona, her sister, told me about it in 1958, but I'd already heard the story through my sister, Ramona, in 1953. I detail more on this under "Golden Cups, Monkey Business, and a Lot of Bull".

In 1995, just before my second edition went to press, I inserted information about seeing an old, 1947 Kodak color print made by the Roswell Army dissectors' photo assistant, during the dissection. That photo was acquired by a man named Bart Wilson, who had told me that he was negotiating with Time-Life Publications and the Sightings TV show people, for sale of the photo. Bart's family member had been in U.S. Army intelligence in Roswell in 1947, which is how he got the photo. I obtained this additional information after Bart's sale, too late to include in my second edition.

Bart's photo showed the splayed facial musculature of a rhesus monkey, pinned out in typical fashion on a board to be photographed for 'documentation' purposes. I immediately recognized it as the musculature of a monkey because the muscles were cut from around the two ears, which produced two strange almond shapes above the cut-outs for the eyes, when stretched out on the board. Bart wouldn't let me make a copy of the photo, as his potential purchasers had insisted on his not doing that.

A few days after Bart showed me the photo for the first time, in the Villa Linda mall in Santa Fe, where Bart's computer imaging and photo processing business was at that time, I mentioned to Bart that the photo verified what I said about the rhesus monkeys, and he said he had a firm commitment from the Sightings people. A couple of days later, I just happened to be at Toys-R-Us, located a few hundred yards across the parking lot from Bart's business. As I waited for my son to look at some toys, looking out a window facing Bart's business location, a tan colored government Hummer pulled up in the parking space directly in front of my view. A man got out and walked directly across the parking lot to Bart's business. I went from the building and looked at the

Hummer. The front had a "CIA" plate, and on the passenger side there was a notice: "Property of Central Intelligence Agency: For Official Business Only."

I checked with Bart later, and he said he had concluded his sale of the photo print to the "Sightings" people on the day I saw the guy in the Hummer walk into Bart's business. I told him the guy arrived in a CIA Hummer, and we both had a laugh. I told him there was no chance that the photo will ever be seen by the public now, which is further proof not only that the "Sightings" show is produced by the CIA, but that they are concealing the "monkey business". It is what a friend calls another one of my "statistically challenging" experiences, that I just happened to be at Toys-R-Us, where the CIA man had parked his Hummer, hundreds of yards from Bart's business, in order to avoid the detection by people like me, of his purchase of the photo from Bart.

The following facsimile news clipping related to the government's covert revival of the Roswell "alien" effort.

Documents link Truman with UFO in New Mexico

Gannet News Service

WASHINGTON - Journalists from as far away as Europe and Japan converged on American University here Friday to look at controversial documents purportedly linking the late President Truman to a recovery operation involving a crashed extraterrestrial spacecraft in New Mexico.

The controversy centers on the authenticity of the so-called Majestic-12 document, allegedly prepared for President-elect Eisenhower on Nov. 18, 1952.

The document was never released publicly and, according to what was presented as a White House memo at the time, only President Truman, two of his Cabinet members and the director of the CIA knew its contents.

The continuing UFO controversy is enjoying perhaps its broadest forum ever this weekend during the "International Symposium on Unidentified Aerial Phenomena: A World View." The symposium lasts through Sunday.

The document reports that on July 7, 1947,

"a secret operation was begun to assure recovery" of a supposed space-craft that had crashed about a week earlier near Roswell Army Base in New Mexico.

"We've spent two and a half years with that document. We are not prepared to state that it's genuine, but there is no evidence so far to suggest otherwise," said Bill Moore, author of a book on the case titled *The Roswell Incident*.

According to the Majestic-12 document, the decomposing corpses of "four small human-like beings" were discovered some two miles away from the New Mexico crash site, indicating they had perhaps ejected before impact.

The M-12 briefing said: "It was the tentative conclusion of this group...that although these creatures are human-like in appearance, the biological and evolutionary processes responsible for their development has apparently been quite different from those observed for homo sapiens."

Under the F.O.I.A., a flock of CIA UFOlogy sheep go "Baa-aa, baa-aa, baa-aa!", asking, in O.S.I.-prepared questionnaires, for "concealed evidence" of a crash which never occurred, involving "aliens" which were monkeys, and "secret contact" between

"extraterrestrials" and our government which never occurred. The "official" government response was easy, merely to deny every (CIA-loaded) leading question asked.

Predictably, the "UFOlogists" asked the wrong questions, so the government was 100% correct in denying 1) knowledge of an 'alien UFO crash' at Roswell in 1947 (since there was no crash, and since, if there had been, it would have been a government flying saucer), and 2) that 'alien bodies' (either three or four) were recovered (since a crash never occurred, and since the bodies 'recovered' were of rhesus monkeys in G-suits). If the group had asked "Was there a government-conducted hoax at Roswell in 1947, in which the bodies of rhesus monkeys (or other primates) were dressed in G-suits (or other costumes designed to look like 'space suits'), to make them appear to be those of 'alien astronauts'?" And, "Did the Pentagon officials retrieve evidence of this first hoax, and cover it up with a second hoax, in which fragments of a weather balloon were substituted?" The old adage, "If you ask a stupid question, you get a stupid answer" applies.

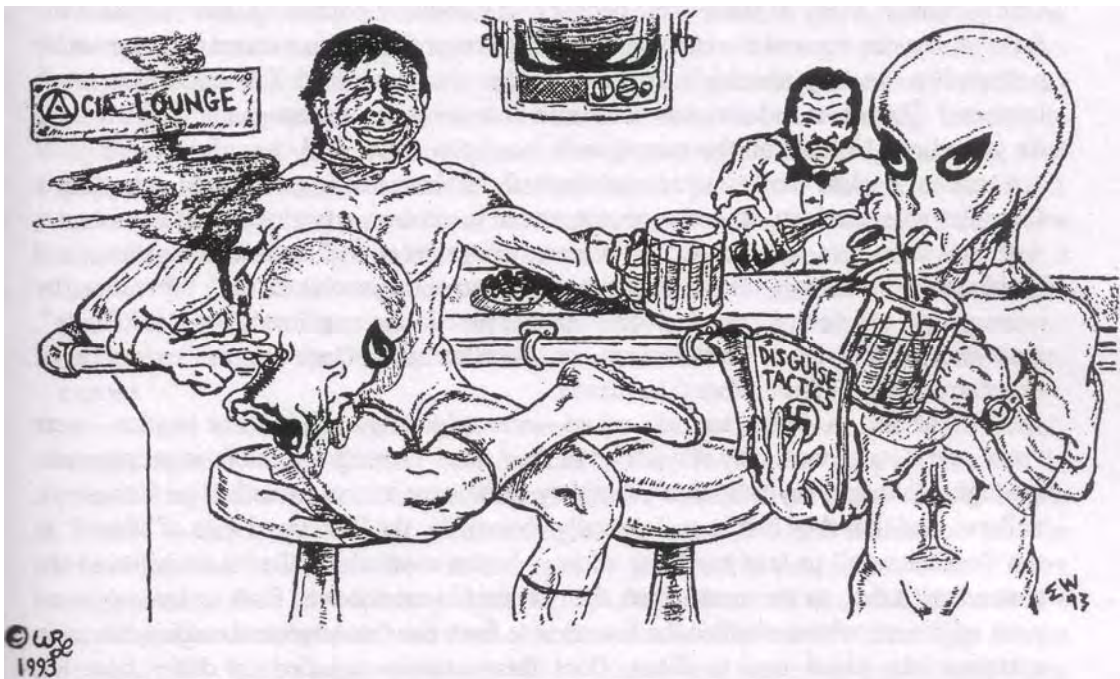

PHONY EXPERT CONSULTANTS AND GOVERNMENT SCRIPTS

The same Arthur C. Clarke who was invited to Keesler by the Air Force in 1956 (whom I called a liar to his face), has been a consultant on many movies involved in this massive hoax, such as 2001: A Space Odyssey, etc. Although such movies as Close Encounters of the Third Kind and E.T. are heartwarming, poetically wishful, and life-affirming, the underlying message such movies deliver—whether by intent or because their makers were duped—is to beg the question that "UFOs" are "extraterrestrial", despite the fact that there is absolutely no known evidence or personal knowledge, verified by any human being, of there being anything made by intelligent

being from beyond our earth. Yet the same Arthur Clarke who in 1956 said saucers "didn't exist", was later involved in these efforts to convince us that they not only existed, but were the exclusive property of "aliens" from outer space. The half-truth and the truth-and-a-half, again.

Every single intelligently formed, fabricated or compounded substance we know of is human-made. The tasks of our government's secret agencies, involved in such movies, are made progressively easier over the years, by the victims (us) already having been duped and brainwashed by the constant, false propaganda drilled into them from the mass media, controlled by BIG BROTHER, for over 50 years. The general public, once known to trust "government experts", has become more skeptical, with their blind trust rapidly waning, realizing that their trust was falsely procured.

A movie like E.T., which may have been intended purely as entertainment, still functionally brainwashes kids before they are mature enough to question our government's actions, motives, or integrity. Realistically-intelligent people, who may never have seen a single flying saucer, usually categorically disbelieve their existence. Oddly enough, many of those same people also disbelieve politicians, and recognize the fact that our government is manipulated by large corporations, in a secret corporate-state partnership. So why shouldn't they realize that the movie and T.V. industries aren't immune? The movie industry has been used extensively as a propaganda medium since its inception. Not all of the propaganda has been false, bad, harmful or evil. But government-backed movies which subliminally brainwash the public into accepting a Platonist epistemology, to make people easier to control, trivializes man's existence, destroys individual autonomy, self-esteem, confidence, and self-determination, and builds false dependency on the government. It also abridges church-state separation, by promoting a religion of "psychic phenomena", pseudo-science, mysticism, "UFOlogy", ignorance, "new age" charlatanism, and blanket acceptance of the existence of extraterrestrials on faith rather than reason.

The fact is, Hitler and his crowd—who originally created these hoaxes—were "new-agers", who were only way ahead of their time. They spread the false propaganda, through a "whispering campaign", that they alone were in contact with alien Venusians, in Peru², and that they had been "specially chosen" by the "advanced race of aliens", as the "master race" to lead earthling society. In the meanwhile, the Nazis believed the contradiction that, as the master race, their "orders" were received from an underground race of giants, who controlled the human race from their underground empire, the main entrance into which was in Tibet. Does this scenario significantly differ from the Trilateral Commission/Illuminati/New World Order/UFOlogy versions? And in a certain way, doesn't it bear a remarkable similarity to stories in the Bible, the Torah, and the Talmud, in which the Christian or Jewish people were supposedly chosen by God or Yahweh, while the various alleged racial and 'spiritual' inferiorities of their enemies were enumerated? And, since the particular proportions and design of the swastika used by Hitler and the Nazis, was the "17-square anagram" swastika of the Jewish Kaballah, it appears that Hitler also drew from that source as a basis for his own new religion, at no fault of today's Jews of the world, most of whom we should hope no longer consider non-Jews to be inferior as stated in the Torah and the Talmud.

²Louis Pauwels & Jacques Bergier, *The Morning of the Magicians*, Stein and Day/Scarborough House, N.Y. (1977).

The people who make these Secret Government propaganda movies, are usually unaware of their backers' hidden agendas, and are 'motivated at their own levels', by a desire for success and profit. There have been only a few movies, to my knowledge, which have touched upon the truth, and they have been more or less banished to oblivion or presented as ridiculous farces. One was *The Formula*, starring Marlon Brando, David Huddleston, and George C. Scott. Another starred Hoyt Axton (I don't recall the title, and there is no information available at video stores either. Perhaps it was a made-for-T.V. movie.). It showed cattle mutilations being conducted by government operatives using helicopters and other strange aircraft. Another movie, *Rage*, starring George C. Scott, also had strong implications, especially in respect to military Masons involved in covering up a government nerve gas "accident".

The *Formula* involved the technological secret of making gasoline from coal. The technology is known today as "acetylene chemistry", and is available in many chemistry texts. The secret originated in the 1930s with an American, the former director of the Colorado Bureau of Mines, who sought a patent on what was then called the "Parry Retort", a refinery and process which cracked a gasoline-like fraction out of acetylene. (Acetylene, or calcium carbide, was originally produced by burning coal in the presence of crushed limestone.) I have seen a copy of the original patent application. The refinery was similar to gasoline refineries, with numerous 'retorts' or 'cracking towers', to separate out or synthesize various hydrocarbon fractions from the acetylene, using what are today standard catalysts such as platinum black, palladium black, etc. The F.B.I. took over the plant, and barred Parry from entry, use, or sale. The technology then came into the exclusive possession of the Nazis—via the Rockefeller interests—who used it during WW II. The *Formula* scenario picked it up from there, mentioning its transfer (back) to Gulf Oil Company (a Rockefeller company), along with the flying saucer, during the "amnesty deal" with the Germans at the end of the war, which I am the first to expose.

Parry's daughter, whom I have known for over twenty years, was unfortunately manipulated by the "Friend" who trained "The Two"—the couple involved in perpetrating extraterrestrial hoaxes through the O.S.I.R.I.S. front group created by the "Friend"—and Jacques Vallee, into stealing my photos of the fake alien saucer and the rhesus monkeys in G-suits. She was also used by CIA-backed people fraudulently suing me, enabling their fraudulent judgments by theft of my trial exhibits, with the unmistakable complicity of the New Mexico courts. The mental instability of the daughter, who has been incarcerated in sanitariums several times, was exploited by these huxters. She was so eager for gallery contacts for her art work, that she was willing to do almost anything for the "Friend" (a CIA pseudo-art dealer, with bad taste). She caused me to miss a trial in a case filed against me by a member of the CFR/IIA, also having connections to the Chicago "Organization".

I love good movies. Movies which faced the realities of flying saucers as man-made machines, would be more exciting than those we've seen. Imagine sitting in the cockpit of one of those babies, clipping along at 2.5 miles per second, with 360-degree view-screens, fed by image inverters! You stop over the enemy camp (the Trilateralists or Bilderbergers), and zoom in on their most guarded secrets with one of your super magnifying image intensifiers, from an altitude so high that you are entirely invisible from the ground, in broad daylight, and do not appear on radar either. Incidentally, "stealth" technology was first developed for Nazi U-boats and flying saucers. Most

probably, the "striations" I identified on the hull of the saucer I saw in 1953, were for this purpose, since that was the way the technology worked at the time.

A good example of one of the newer, slicker propaganda movies, was *Hanger 18* (1980, Taft International Pictures, Inc.; Worldvision Enterprises, Inc.) It was produced by Charles Sellier, Jr., and the cast included Gary Collins, Robt. Vaughn, Joseph Campanella, Darrin McGavin, and James Hampton. These are some of the same actors often appearing in Secret Government pseudo-documentaries or pseudo-expose-type pictures. An opening statement was "...brave eyewitnesses have stepped forward and now the story can finally be told". This hypocritical statement should more appropriately have said "...cowardly liars have stepped forward, and now the Big Lie can finally be told".

There was ample government involvement (use of the air base at Big Spring, Texas, cooperation of NASA, etc.). The plot involved a fictitious satellite explosion, caused by a collision with a "UFO", which was hovering near an orbiting NASA space shuttle dock. One of the several astronaut-witnesses was killed by the explosion (heroes all), also killing the saucer's alien pilot, after which the saucer made an automatic controlled landing in Bannan Co., Arizona (why always the desert?).

Two of the astronauts sought to expose a "government cover-up" conspiracy, and were hunted down by government agents, who killed one of them. In spite of the phony sympathy created for 'those who sought to expose the government's concealment of alien contact', the film took every opportunity to plug NASA and the space program, while creating apprehension by implied death threats against potential witnesses who attempt to tell the real truth. A typical line (Vaughn): "So what you're saying, General, is that we have a flying saucer in our possession?", (as if to say that "we" did not!).

Hanger 18 was supposedly a secret NASA hanger "...within fifty miles of Midland, Texas..." (presumably Big Spring). The plot included the theory that ancient markings on earth, such as those on the Plains of Nasca in Peru, or Totonac writings—based on phony-baloney linguistic comparisons—were the same as those found inside the fictitious UFO. The "Hanger 18" incident was just another government-concocted hoax like the MJ-12 and Roswell hoaxes, only with better technical and conceptual work.

By 1994, my first edition kicked up enough dust to spur a Viacom Pictures, made-for-TV movie, *Roswell*, starring Kyle McLachlan, Charlie Sheen, Dwight Yoakam, etc., produced by Ilene Kahn, etc., (based on the Kevin Randle and Don Schmitt book, *UFO Crash at Roswell*). They even had a spooky 'bad guy' exclaim to Kyle McLachlan, "It was just a bunch of rhesus monkeys!" (a direct quote from my book, and a front page Albuquerque Journal North newspaper article on me and my book, of Jan. 6, 1994). I find it odd that attribution was not present in the Randles/Schmitt book, which showed the real motive for doing the movie, based on a book which could be bent to government purposes, if it was not initially commissioned by the government, similar to how the "Friend" had tried to commission me to write a book attributing the petroglyphs to extraterrestrials. By 1994, Schmitt and Randle weakly attempted to address the rhesus theory raised by me, without saying who raised it, in their later book, *The Truth About the UFO Crash at Roswell*, the title alone of which showed their OSI affiliation, since they have always known there was no "UFO crash at Roswell", but a "fake crash".

Rancher Mac Brazel was depicted as a reluctant 'patriot' during an intimidating 3-day interrogation, while admitting that he took a \$3000 payoff to stand behind the

government's second, weather balloon hoax, after he had already helped in the first rhesus monkey hoax. He changed his story, saying the weather balloon debris was there for two weeks before he reported it. This created the suspicion that he was paid off to conceal a real alien crash, and to account for the time between the first hoax and the second hoax. Besides, they would have had to pay him again for a second hoax.

Approximately one week after the Journal North article, as I returned home from Santa Fe at dusk to Lamy, I saw a very large flying saucer (appearing to be at least 100 feet in diameter), hovering within a quarter mile across Apache Canyon (A.K.A., "Galisteo River") to my east, which was putting out a large amount of coronal flame. Though I am not in a habit of photographing every saucer I see, I ran for my camera, because it was a good sighting that my camera could have captured, but before I could get set up, it was gone. It traveled across the Eldorado Subdivision to my north, and moved on a bee-line across the southern periphery of Santa Fe, into the northeasterly end of the Jemez mountains, toward the "technical areas" in the southwest side of the Los Alamos Scientific Laboratories, where the saucers fly quite often. I discussed it with some friends in Eldorado, and they said they saw it and reported it to the Santa Fe County Sheriffs Department, and were told that three other witnesses had already reported it. Friends in Canonicito also confirmed their sighting of the saucer. It was as if the government had placed an obvious and large saucer in the area, just to see if my book or the article had produced any effect on the local population. The saucer sightings have been so prevalent and outrageously obvious in the past, over the Canonicito area, that I would have found them disturbing if I had lived over there, and they have at times been irritating in my own area around eight miles to the east, but I am further from the tip of the southern Sangre de Christos, where the government has chosen to place them so often at night. Presence of lower altitude saucers in this area have noticeably diminished since the book and this news article, even though the public has been brainwashed to 'not see them' anyway.

MY "FRIEND", THE M.I.B.

"M.I.B." is an acronym for "Men In Black", the Secret Government spooks who often show up to harass witnesses. My reference to a so-called "Friend", is to a man who is and was one of them. He also created some of the hoax scenarios for the CIA/OSI, involving pseudo-linguistics, pseudo-archaeology (ala Zechariah Sitchin), as well as the O.S.I.R.I.S. group used to 'smokescreen' the cattle mutilation/stealth weapons test program. This archaeology/linguistics brand of government lie has always angered me, because of the tendency to blur and confuse the work of those who are engaged in responsible linguistic inquiry and archaeology, yet which may be vulnerable because they are divergent and out of the mainstream. The flaky and irresponsible fabrication of 'extraterrestrial' interpretations, tends to put a blight on new breakthrough work being done, as if it were also false. For example, around 1977, I had begun to make headway with petroglyph research indicating connections between American Indians and specific, ancient Middle Eastern, Indo-European, Semitic, Asian, Norse, and Celtic writings, languages, cultures and peoples, about which I was contemplating a book.

I was astounded when the "Friend" (whom I had known for several years), paid me a visit in 1977, and announced his intent to institute a program attributing the petroglyphs to "ancient space aliens". He was the M.I.B. who had lived in Santa Fe with

and trained the couple of government-paid U.F.O. shamsters known as "The Two" in 1972 (Marshall Herff Applewhite and Bonnie Lu Nettles). He later exploited the mentally disturbed daughter of the inventor of The Formula. I realized at that time, that his fraudulent work was being sponsored by the intelligence community, for whom he had worked for years, and continued to do 'contract work' for.

I noticed that, in my presence, he wore a Shriner ring. This was to gain my trust—or better still, to shut me up—on the erroneous assumption that, since CIA files showed I came from a "Masonic family", I would feel compelled to "keep the secrets". This, in spite of the fact that he was a graduate of a Catholic school (U. of Denver). One of the primary tenets of the Masonic Oath is never to betray a trust. To me, it wasn't my trust he sought, but rather my complicity in a secret betrayal of the trust of the American people. Even if I had been a Mason, which I am not, gaining my trust through such a fraud would have nullified the oath. He erroneously thought that he was 'motivating me at my own level.'

It angers me that the intelligence spooks exploit entire fields of knowledge and professions, sacrificing them to government 'expediency', by generating knowingly false programs designed to conceal technology from the public and to brainwash them in BIG LIE mass-psychology programs ala Hitler. These programs are to subliminally control people by propagating fantastic, ignorant and twisted lies which elevate insane and irrational elements of society, at the expense of knowledge, reason, and truth. It astounded me that the "Friend" could hypocritically look me straight in the eye, while my life was all the while being cruelly torn apart by their covert harassment. It occurred to me that a committee had worked this all out on paper somewhere, and that individual rights and human life didn't matter to them, so long as they fabricated the 'right' interpretations of things which helped them to control society.

While in graduate school in art at U.T., I was appalled to learn that the fields of art and art history were cynically considered 'expendable' to the CIA people, who referred to artists as "...just a bunch of paranoids...". They had permeated both the faculty and the student body of the university art department. To them, the "cover" of artists and art historians were ideally suited for deceitful, intelligence-gathering foreign travel, photographing strategic defense areas, picking up and delivering data, acting as couriers, etc., and little else. It was my judgment that the people who do that are no better than the closet homosexuals who marry in order to present a false image of themselves to society as being heterosexuals. There were no less than six CIA professionals on the art faculty at U.T. in 1969, and several CIA and military intelligence operatives posing as art students. I wondered how many operatives they had in other departments of the university. Those who posed as students seemed to be spies on the students and the faculty. Since the Viet Nam war was in full swing, 'draft counselors' seemed to be among their prime targets, but I suppose that any excuse could have served as a pretext to continually meddle with and control what would otherwise have been a natural, and more just flow of the affairs in a supposedly "educational" institution.

In the fall of 1977, the Friend made the trip to my home for the specific purpose of dissuading me from publishing this book, and had the gall to lay out the phony hypothesis for HIS book, which he expected me to write. At that time, he had apparently become disturbed not only by my plans for a flying saucer book, but because I had also begun to branch off into petroglyph research, which threatened to interfere with his official Big Lie plan to interpret the petroglyphs as the "writings of extraterrestrials".

He had apparently dreamed up the alien petroglyph hoax, and enticed me with a lucrative CIA contract, to draw me away from my saucer book, thinking that, once I had collaborated in the false "alien archaeology" lies, I would be "hooked", to be compelled by my published change in position, to fit in with the "alien saucers" lies. This opportunity to prostitute my intellect for cash, included the guarantee that the publishing contacts were already set up and ready to go, in Sedona, Arizona.

I hit the ceiling, saying that I had personal knowledge that flying saucers are man-made, that the government's program of spreading the gospel of E.S.P., Edgar Cayce, and extraterrestrial origin of flying saucers, was a Big Lie originating with the Nazis, and that I would never cooperate in the spreading of such trash. I told him of my broad-daylight sighting, that my parents were present among more than seven witnesses, and that they had often seen whole squadrons of saucers in the Dakotas. This information on my parent's sightings turned out to be a serious mistake, as I underestimated the extremes to which the CIA would go to suppress witnesses. Besides, why argue with someone who already knew the truth, and only wanted me to join into the lies to conceal it for fun and profit?

He then attempted to intimidate me, and even threatened me, recounting some of the bad things which had happened to some of those who had refused to cooperate, or had "gone too far" (presumably by doing such things as revealing the secret manipulations I am telling you about in this book).

A couple of weeks later, I was visited by my father, who was on his way from the Scottsdale, Arizona, merchandise mart, to Thornton, Colorado, where he and my mother then lived. They ran a lucrative market-building business in womens' sportswear, providing representation for six Dallas manufacturers and a couple of west coast labels, in around seven or eight states. My father was a member of the Board of Directors of the Dallas manufacturers' association, my parents maintained showrooms in Dallas and Denver, and they had built the markets in Nevada, North and South Dakota, Wyoming, Colorado, Utah, Arizona, New Mexico, and parts of Texas. For ten years, they traveled over 100,000 miles per year, in the "flying saucer states". It was the only visit I can remember in which my father came alone, without my mother.

After visiting with my father for a half hour or so, he brought up flying saucers, and to my surprise, urged me to stop telling what I knew about them. Since this was only a few days after the Friend had threatened me, I assumed that my father's visit was somehow connected, another attempt by the CIA to "shut me up". To my dismay, my father then denied ever having seen flying saucers, despite the many times that he and my mother had told me about seeing whole squadrons of them over such areas as North and South Dakota, and the mountainous country near Cheyenne Mountain, Colorado, deep beneath which is the underground N.O.R.A.D. Command Center.

This behavior was very unusual, and I wondered how the Friend had manipulated my father's conduct, speculating that he may have exploited the "Masonic connection", since I had seen a Shriner's ring on his finger. My father is a 32nd degree Mason, and my mother is a highly-esteemed member of the Order of the Eastern Star (the female Masons). For what it's worth, I had been a charter member and officer of the Winkler County chapter of the Order of De Molay (junior Masons) when I was a boy, but never considered becoming a Mason because I am an Atheist, since I knew that initiates were required to swear a belief in "Almighty God". As I said earlier, the Shriner's ring was evidently one of his CIA cons, an attempt to represent what he thought would 'motivate

me (and my parents) at my own level.' The 'con' had apparently worked on my parents, who are Masons, but not me.

As for suggestions of a connection between Fascism and Masonry, it seemed improbable, at least among the American Masons and a few northern European Masons I have personally known, though there was some rather compelling evidence unearthed in Italy, in the "P-2 Lodge Controversy", about which I will have more to say later.

My uncle Roger Benton had been a 33rd degree Mason, in the original First Grand Lodge of Texas, at Nacogdoches, founded by Stephen F. Austin and Sam Houston, and was a Shriner (the military Masons), and I knew that he would have nothing to do with an evil plan to subvert the constitutional authority of America, or to subjugate any race. Roger had driven an L.S.T. in almost every major invasion in the South Pacific, and had been the world's first radar gunner on the Navy's "Black Widow", in its record-breaking mission over Tokyo, and had proven that he was prepared to make the supreme sacrifice to stop Fascism, fighting bravely for the freedom of the Phillipinos and others. If the Illuminati Fascists worked within the American Masonic Orders, he apparently knew nothing of it, since he was anti-Fascist, and simply not the kind of man to tolerate such an attitude within himself or among his associates.

I wondered how my father had been persuaded or scared into lying, since he is highly opinionated and stubborn, painfully truthful, and unlikely to change his mind because of what someone else wanted. It was indeed uncharacteristic behavior on his part, which was inexplicable except by the application of extraordinary pressure, subterfuge, or threats. In dismay, I accused him of cowardice in the face of government intimidation—the kind of feudal extortion that good Masons are supposed to resist—for whatever reason unknown to me at the time. Because of that incident, my father and I didn't speak for over five years. I finally forgave him, since he is an elder person. How could I expect him to stand up to these creeps? Who knew what kind of threats or powers were invoked by the "Friend", to coerce my father?

The next evening, in the late fall of 1977, in a local coffee shop, I was invited by a well-known Santa Fe art dealer I knew, to join he and his friends. I brought up the subject of flying saucers, having in mind the "Friend", whom we both knew. The dealer had just returned from the Scottsdale market. When I mentioned my father's recent visit there, he said that he had met him, and said that they had seen him talking privately to the "Friend" in Scottsdale, only two days earlier, thus confirming contact between the "Friend" and my father. The secrecy made the following facts apparent: My "Friend" never mentioned knowing my father, and vice-versa. My father (and mother as well) had been intimidated and coerced by the "Friend", to stop corroborating my sightings, and to cooperate with his attempts to shut me up. My father had been forbidden to tell me about the extortion, proven by their behavior and the secret contact.

Having independently discovered the fact that the "Friend"—named James ("Jim") Parsons, who really isn't my friend—had threatened my father, I discussed it with a girlfriend, who inadvertently relayed it to Jim, whom she also knew. I had failed to warn her not to discuss the matter with the Jim, which I didn't expect to happen anyway, but it did. Within two weeks, the Dallas manufacturers, without warning or authority, 'fired' my parents, who had built their markets for ten years. Since my girlfriend had inadvertently told Jim that I knew of his threats, he incorrectly assumed that my father had disobeyed him and told me about them, so he arranged for them to be fired, in attempt to 'get to me'.

With a ring of poetic justice, the manufacturers lost millions of dollars, due to the loyalty of some of my parents' purchasers in their territory. As I learned from one of their associates, an older man who also marketed ready-to-wear, Mafia Don, Joseph ("Papa Joe") Bonanno—who, believe it or not, ran a womens' sportswear shop in Tucson—smelled the federal rat, and organized a boycott. The other shops in my parents' territory, boycotted the manufacturers, as a protest against this injustice, and their market generally broke down. Poetic justice sometimes comes in strange ways, from unexpected quarters. I have always wondered if the government ever fully compensated Louis and his Dallas associates for their losses, or whether they ever knew why they occurred. If not, the M.I.B.s made suckers out of them too. I have often wondered how much it was worth to the government.

I published the following material in my 1993 and 1995 first and second editions, years before the Heaven's Gate cult's suicide at Rancho Santa Fe, California, in March, 1997. Years earlier, I had learned from another girl friend—whose name shall remain anonymous—that Jim had intensively trained "The Two" in late 1972 and early 1973, for three months, in a house the threesome shared in Santa Fe. The 1997 mass suicides highlighted Jim's mysterious CIA training of Marshall Herff Applewhite and Bonnie Lu Trusdale Nettles—"The Two"—who had immediately founded "HIM" ("Human Individual Metamorphosis"), and several other cult CIA front groups, following Jim's training. I had known since early 1973 that the cult was connected to the CIA, the primary purpose being the concealment of government saucer and cattle mutilations activities. Jim's subsequent cover-up of his associations with the cult leaders in articles published in area newspapers, showed his desire to conceal the CIA's involvement. "Never run 'til you know you're being chased," they say.....

Beginning in the '70s, investigative reporters wrote exposes on The Two, documenting their pattern of infiltrating communities—pretending to be previously unassociated transients—then becoming 'associated', after which the members would become 'followers', to be 'convinced' that they were descendants of an 'extraterrestrial race', and that it was "time for a flying saucer to come from outer space to pick them up" at a designated time and place, and take them back to their 'home planet'. After spreading word of this around the community—for maximum propaganda impact—the group would meet on the appointed evening, drive to a certain hill or other landmark, park their cars, then mysteriously 'disappear', leaving their cars behind.

The media coverage was orchestrated concerning the strange 'disappearances', along with the usual paranormal and UFO magazines. The abandoned cars, which were indispensable for the sham, were hauled away to local public pounds. The remaining members of the community, and the media's interviews of them, were relied upon to spread word of the mysterious 'departures'.

This worked pretty good, until some smart investigative reporters trailed the members, took down their license plate numbers and auto makes, etc., at several hoax sites, and did some comparisons. It turned out that the same "Two", and the same "followers", driving the same autos, were repeating the same scenario all over the western U.S. The incidents showed the compliance of local police and authorities, by first impounding, then releasing the cars, to the 'disappeared' owners, to be used again, with no reports by public officials correcting this in the public media or police reports.

Jim had studied law at the University of Denver School of Law, prior to entering the Air Force, serving in Air Force Intelligence (the O.S.I.), from which he had retired at

the rank of colonel, after which he had taken up "civilian" employment with the O.S.I., apparently continuing to do 'contract work', recruiting and training huxters, and designing hoax scenarios, to convince dupes that flying saucers are from "outer space". The following facsimile clipping completed the connection (emphasis mine):

Calf death, UFO group tied

LAKE VILLA, ILL. (UPI) - Two calves found mutilated at a farm in this rural area northwest of Chicago may have been killed and butchered by would-be voyagers to another planet, according to police.

At meetings in Waldport, Ore., and elsewhere in the Pacific Northwest, a woman known as "Her" and a "holloweyed" man known only as "Him" reportedly enlisted followers for a UFO trip.

Friends and relatives of missing persons reported to have joined the band have expressed concern about their whereabouts and well-being.

A band of 50 to 70 persons who may have been followers of the mysterious couple camped at Chain O'Lakes State Park about 10 miles from here early this month, using the park as a staging point for their planned UFO journey to another world. The campers' cars bore license plates from Oregon, Washington, Colorado, Texas, Arizona and one Canadian province.

License plate numbers on three of the cars were reported to have matched those of cars that disappeared with 23 persons from Oregon after a meeting with the couple at Waldport.

A woman appeared to be in charge of the group, some sources reported.

The calves were slaughtered about the same time the group was at the park.

The first slaughtered calf was discovered Oct. 1. Only the calf's head and internal organs remained and police said the head was so neatly severed that

no blood could be found anywhere around the remains.

"It seems like someone was looking for something to eat," Lake Villa Police Sgt. Raymond H. Engel said.

The carcass of the second calf, found Oct. 5 about 1,000 yards from where the first was slaughtered, was virtually intact. Only the calf's left ear was missing. It had been cut off, Engel said, and could not be found.

Some believers in UFO's have said aliens cut off animal organs in order to take them back to their own planet and study them.

Engel said there was no evidence as to who killed the calves or why.

The campers believed members of the UFO cult began arriving at Chain O'Lakes State Park Oct. 1 or 2, with others arriving Oct. 4, according to State Forest Ranger Mick Egan. All appeared to be financially pressed---even to borrowing a nickel from a gateman to help pay a camping fee. They repaid the nickel.

Egan said members of the group "were clean and neat and very well behaved."

He said the group held a quiet meeting on Oct. 6 and left Oct. 7 after newspapers in the area published reports about the mysterious UFO group.

Although the group apparently left the area and there has been no trace of them in the Midwest, authorities told the 1,000 residents of Lake Villa to report "any strange goings-on."

Another girl friend, who had known both Jim and The Two, had said in early 1973 that the couple had been "...recruited and paid by Jim for some kind of training", during the three months in which they had shared a house in Santa Fe in late 1972. All our friends thought that it was mysterious, since the training was so secretive. At first we thought it might be some sort of kinky sex cult, but everything was clarified later when the couple was identified in 1973 news articles as the leaders of HIM, and later, in 1987, as the leaders of the O.S.I.R.I.S. ("Outer Space International Research and Investigations Society") hoax.

Having known about Jim's training of the couple in 1972, prior to their hoaxes, the purpose of the hoax was clear to me, especially in view of the various inducements, coercions and subterfuges specifically regarded UFOs and "aliens", which were applied to me and my parents in 1977, by Jim, the O.S.I./ M.I.B. who had instigated it, to shut me up about flying saucers or to coerce me into writing propaganda for the CIA. After all, it would have been clear to even an idiot that Jim was doing all in his power in 1977 to force me and others to propagate lies about "aliens".

When I encountered Jim at the "50th Anniversary of the Roswell Incident", in July, 1997, he was extremely nervous about my presence, afraid I'd blow his cover.

When the news hit the papers in late March, 1997, about the "mass suicide" of the "Heaven's Gate Cult", I figured that the CIA had decided it was time to 'close out' the 24-year-old operation, which hadn't been very productive of significant, new propaganda for years. This was especially so where I had already identified it for the public as a CIA front in my 1993 book. With its members aging, their activities slowing down, they were beginning to look more like a geriatric care group, so what else was to be done with them, since they had been 'programmed' for years and were dependent on the group. The CIA, couldn't have these 'loose cannons' rolling around on the deck, so they were heartlessly 'put to sleep' like tired old dogs who were no longer of any use to their CIA mind-control masters.

With the mass deaths, Jim was nervous. Just as articles he had written for the Santa Fe Reporter in 1975 had lied about his earlier connection to the HIM cult and The Two, the articles he wrote in 1997—four years after my first edition—just after the horrible news of the cult's 'suicides', was intended to conceal the guilty knowledge of a nervous CIA propagandist, concerning the many deaths which he had contributed to as the creator or the cult. In an article by Jim in the Albuquerque Journal, of Sunday, April 6, 1997, entitled "Man Tells of Friend Joining Heaven's Gate" - "Santa Fean Saw Cult Lure Friend", Jim said "One day in 1975, I encountered a group called Human Individual Metamorphosis, and showed Gordon a flier for a public lecture the next Saturday." Thus Jim had "showed Gordon" a flier and begun to 'recruit' Gordon Welch, his roommate, in 1975, into the cult Jim had created, and which was eventually the end of Gordon. Of course he didn't tell Gordon or the newspapers that he had created the cult. It was clear from Gordon's letters to Jim that he was a complete dupe, unaware of the fact that Jim and the CIA were behind the cult, and that, to them, he was just a piece of animated meat they had chosen because of his innocent gullibility, who had been programmed to act out stupid fantasies to conceal flying saucer technology, as well as to provide more propaganda mileage for the CIA, to feed the demented minds of whatever suckers were out there.

In one of Gordon's letters to Jim, he stated, "I hope I am in the final stage of this thing. I still believe it is true but it is very hard and demanding as we learn to go to a world where you live a large part of your time on spaceships and communicate by projecting thoughts. Have to work on getting all thoughts pure and good and honest and direct. That's a tall order."

At one point in the article, Jim described how he had gone with Gordon to Albuquerque to attend a HIM meeting, and a 'reading'. Jim gives us his thoughts: "Driving back to Santa Fe, I pondered this reading and decided to reverse my skeptical attitude about flying saucers and HIM." At the head of the article, it was stated, "Authorities say one of the victims from last month's mass suicide in Rancho Santa Fe, Calif, was identified as a Gordon Welch."

I have to laugh about Jim deciding to ".reverse" his "skeptical attitude" about flying saucers and the cult activities HE created. Since I met him in 1972 he had always had this inflexible attitude, especially in the presence of impressionable new-age types.

The O.S.I.R.I.S. front group activities are shown through the eyes of another dupe, by the following Albuquerque Journal facsimile clipping (emphasis mine):

Believer in UFOs Says He Met Space Being

BERNALILLO - Ray Keller believes in extraterrestrials because he met one.

In the summer of 1987 Keller and members of the Utah chapter of **Outer Space International Research and Investigations Society** were on a pilgrimage to Mount Shasta.

He said they chose the site because of the many reported sightings of unidentified flying objects in the area. **One legend says the mountain is hollow, a super-garage for spaceships or a temple for space visitors.**

While he and the others were hiking beyond the tree line, a woman appeared as they rounded a boulder near the peak.

"She was a lady with red hair about 5 foot, 6 inches and she was wearing a white jumpsuit for want of a better word," Keller said.

"It's bare up there. There were no trees that she could have been hiding behind," he said.

He said the other pilgrims identified themselves as part of a UFO group and the woman said, "I know why you're here."

Although he didn't want to elaborate on what the woman said, she talked to them for about two hours and let them take her picture.

As the group was leaving and turned to wave good-bye, the woman disappeared, he said.

Keller, 34, who works for the Head Start program in Bernalillo, said he sighted his first UFO at 13 while he and other Boy Scouts were on a camping trip in Ohio.

Keller said he believes that his experience is not unique. **On Sunday at 2 p.m. at Bernalillo Town Hall he will talk about reported sightings in New Mexico.**

Ray Keller, quoted on the previous page, a member of O.S.I.R.I.S.—another CIA front created by Jim—worked in early childhood development, and was involved in the Boy Scouts, a perfect sucker. The CIA/OSI front group he belonged to was named for a deity of the ancient Egyptian religion, "Osiris...the Beautiful Hare"³. Though the name for the god "Osiris" was derived from a folk mythical hare (the Easter Bunny), as shown by references noted in 1886 by Budge in *Egyptian Book of the Dead*, they remained unnoticed until my 1993 first edition. I had already derived this fact from independent research in etymology, in which Osiris, as a hare ("Heru-"), was associated with Isis, a duck or goose ("Khuti"), who gave birth to Horus ("Heru-Khuti"), from the earliest times in western Siberia, in the mythology of the Uralo-Altai-speaking peoples.

The naming of the UFO 'research' group—run by a CIA/OSI counterintelligence team—after Osiris, shows the earmarks of the former SS RSHA Gestapo spooks who formed the core of the CIA's Office of Scientific Intelligence, Science Directorate, Covert Operations (flying saucer cover-up teams). Movies from '20s and '30s Germany show parades of 'pre-Nazi', Thule Society-sponsored 'new-agers', in ancient Sumerian and Egyptian costumes, holding ceremonious pagents, propagating the mythology of Ostara, the Nazi religion created by a Cistenian monk, Adolf Joseph Lanz, founder of the Order of the New Temple in 1900. That same year, at Lambach Abbey in Upper Austria, Lanz initiated the boy, Hitler, into this religion. He then left the order, and under the alias Georg Lanz von Liebenfels, began publishing the Hyperborean and anti-Semitic periodical, *Ostara*, in 1905.⁴ The Ostara religion, as the basis for the Thule gesellschaft, was one and the same as the new religion which I mentioned as being 'revised' for American dissemination, using von Liebenfel's manuscripts, by Charles Hundley⁵, as Astara, to be led by the Cheneys. This group is now known as The Ashtar Command, and is also the basis for the script for the TV series, *Stargate*. It is also the basis for the writings of Zechariah Sitchin, regarding the alleged extraterrestrial origin of the Sumerians, the same kind of stuff which Jim tried to hire me to write in 1977.

The Egyptian esoterica ("O.S.I.R.I.S.", etc.) was used by the CIA to imply involvement of an occult group, or a group of 'extraterrestrials' who practice or originated that religion. This fits in with other parts of the 'puzzle', by saying that the ancient Egyptians were extraterrestrials. The O.S.I. group known as O.S.I.R.I.S., specializes in appearing at the sites of cattle mutilations, to suggest that the mutilations are occult-related, and to falsely absolve the Secret Government, according to the "Puzzle Palace" tradecraft. We are expected to investigate and to 'discover' that occult groups, practicing the Egyptian religion, are holding "golden cup" ceremonies.

The Nazi influence in our society exists in many forms, often unrecognizable even by people who should know better, often due to the concealment of the actual nature of the Nazi phenomenon, perhaps through the influence of people like Reinhard Heydrich and Heinrich Mueller of the CIA. In the following news item, there was less room for doubt. New Mexico State Policeman Leonard Fietze, shows his admiration for the "Guru" (which in German, is "Fuehrer", referring to Hitler):

³E. W. Budge, *Egyptian Book of the Dead*, Introduction, p. cxxii (Un-nefer defined as "The Beautiful Hare"; p. 254,- Un-nefer interpreted as "Beautiful Hare" [citing Proc. Soc. Bib]. Arch. 1886).

⁴Jean-Michel Angebert, *The Occult and the Third Reich* [Chap. 11, Catharism and Hitlerism].

⁵Discussions between the author and Charles Hundley (the CIA/ONI co-designer of Project Bluebook), Columbus, Ohio, 1958-59.

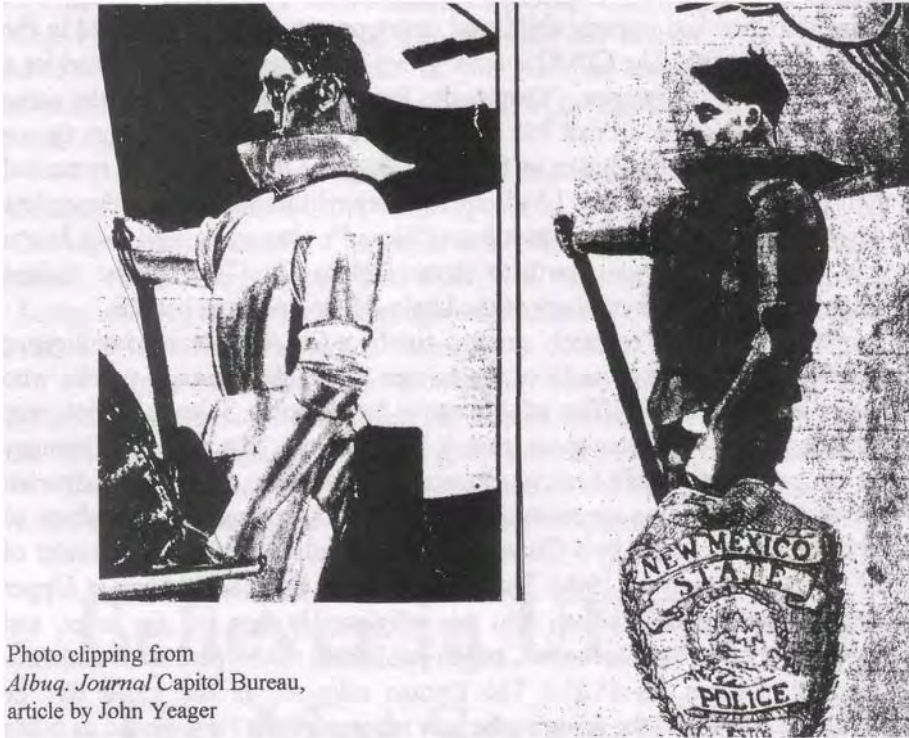

Photo clipping from
Albuq. Journal Capitol Bureau,
 article by John Yeager

The Order of the New Temple which Joseph Lanz set up in 1900 was inspired by the Templars, with Lanz as the Grand Master, as a successor to Jacques de Molay.⁶ The original painting of Hitler as a Knight, in Templar regalia, clearly referred to the Nazi neo-Templar tradition. The New Mexico State Police "Knight" on horseback—copied from the Hitler painting—searches for the "Holy Grail" (the "Golden Cup"), which is the Nazi double symbol of "pure blood" and "knowledge". This neo-Templar theme, a fundamental tenet of Nazi SS novices, in their training under Heinrich Himmler at Wewelsburg Castle, seems to have surfaced again in America.

A White Sands Missile Range Army Security document, placed in the mailboxes of teachers at the White Sands Missile Range School, where I taught in 1970-71—to 'warn' us about the awesome evils of "atheism" and the "peace sign"—was evidence of the kind of "knowledge" to which the Nazi/Christian/Templar "golden cup"/"Holy Grail" myth refers. Disturbing as it may seem, the connection between Fascism, God, the De Molays (junior Masons), and the national security establishment, was obviated by the 1971 document, which contained quite a number of errors and inaccuracies. The document demonized Atheists, even though Atheism is a religious preference protected by the US. constitution and Bill of Rights, which means the security people don't respect our American freedoms, and appear to have something else in mind. Note following words, "De Molay", "Christianity", and "Atheism", in the text of the White Sands Security Bulletin, Security Office, Intelligence Division, dated 19 Apr., 1971, which quotes directly from the New Mexico DeMolay News, as follows (emphasis mine):

⁶Jean-Michel Angebert (Supra) Chapter 11.

"With the permission of the DeMolay Association of New Mexico, the following article was excerpted from their January-February DeMolay News, Vol. 6—No. 1.



This illustration most of you will recognize as the 'Peace Symbol.' It is a popular emblem with protestors, draft card burners and flower children. Furthermore, it has become a popular fad with unsuspecting youth to embroider it on their clothes and paint it on their cars.

Peace symbol? Hardly. Nor is it a product of today's youth. The symbol is an ancient one, but it has never been associated with peace. It is actually one of the Satanic symbols known as the broken cross or the 'crucified cross.' In short, it is one of the marks of the Anti-Christ, the sign of Satan. During the Middle Ages, it was known as the 'Witch's Foot.'

Look closely and you will readily see why it was adopted as the subtle sign of those opposed to Christianity----- it is a broken cross turned up-side down.

One of the nation's most sophisticated magazines, the NEW YORKER, said in a recent article that the so-called "Peace Symbol" was adopted by various 'youth organizations' on direct orders from the Communist Party. It is part of their long range propaganda campaign to attract youth into subversive Communist-directed programs. They seek to encourage young people to express contempt for adults, for authority, and for the ideals of patriotic Americans.

Be sure of one thing, the Communists are gleeful when they see this mark of atheism worn by Americans, whether knowingly or unsuspectingly.

PEACE SYMBOL???

FOR THE COMMANDER

(signature)

VINCENT B. COTE

LTC, MPC

Chief, Security Office

DISTRIBUTION: (1/70)

D except D-50 (1,000); F;

AMSEL - bl (12)

AMSTE -SE- (2)"

The document had a quaint naivete to it, as well as some basic theological ignorance. If the peace sign was a mark of "Satan", how could it be "Atheistic"? Wasn't Satan supposed to be a 'fallen angel'? An Atheist doesn't believe in such mythology, so there could hardly be a connection between the peace sign and Atheism, even if it were a Satanic symbol. Satan is supposed to be an enemy of his father, God. How could he disbelieve his father existed? An Atheist can't be an "enemy" of God, because to an Atheist, God doesn't exist, and you can't be an enemy of something which doesn't exist. Immediately following this oxymoronic "Army Intelligence" blunder, an article appeared in Navy Times, which gave a more "knowledgeable" history of the iconography of the "peace sign" than the one written by Army intelligence Fascists at White Sands, who wanted to equate the peace sign with "Satan's little plan". Navy scholars related the peace symbol to the semaphore alphabet, as a combination of the two diagonals ("N"), and a vertical line ("D"). It was first used by a London group called Direct Action Committee Against Nuclear War during the 1958 Easter March at Aldermastoh. A facsimile of the NavyTimes clipping follows:

Peace symbol originated from semaphore alphabet

THE NAVY TIMES, in its April issue, Disarmament. They are superimposed on a circle to make up the peace symbol. claims the world famous peace symbol is an old Navy signal.

Despite the number of fables which have sprung up concerning the controversial symbol, the Navy says the symbol's origin is really the common semaphore alphabet used by the world's navies.

The signal for "N" and for "D", when used together, stand for Nuclear

It was first used by a London group called Direct Action Committee Against Nuclear War during the 1958 Easter march at Aldermastoh. The lore that has since grown around the symbol includes the claim that the circle can represent an unborn child, a human in despair, or a broken cross.

Judging from the Nazis' involvement with Masonic teachings regarding Solomon's temple, the Tower of Babel before that, and to their eclectic infatuation with related esoteric material—as indicated by the triangular Illuminati symbol for the "p2" project run by von Braun in 1937 New Mexico—it is only natural that there was a Nazi-Masonic connection, and a Masonic-White Sands Missile Range Security connection, along with Masonic connections to many other covert government operations as well. The von Stauffenberg conspiracy to assassinate Hitler, for example, was an attempted coup d'etat by aristocratic Prussian Masons, to install Field Marshall Erwin Rommel as the new Fuehrer. Hitler may have been the dictator of Germany at the time, but he was not Germany itself, and the Masonic plot was intended to get rid of Hitler, and create a new government which could join with America and England to stop the Soviets. Just as the White Sands Security Bulletin disclosed information relating to Masonic influence in the group which ran the Army security operation at White Sands,

the Masonic scandal in Italy involved an attempted neo-Fascist coup d'etat, by members of a clandestine "P-2" Lodge, a lodge with a coded name which meant "Propaganda-Due" ("Propaganda-Two"), which referred to the dualistic nature of a covert, Masonic government which uses "dual propaganda" to control the public, similar to the "Siamese Twin Big Lie System" I have detailed, and the Hermetic principle.

The following facsimile clipping relates to the Masonic scandal in Italy involving the attempted neo-fascist coup d'etat:

Italian official quits in scandal over Masonic Lodge

ROME (AP) - Justice Minister Adolfo Sarti resigned today after his name was linked to a Masonic lodge that prosecutors are investigating as a possible "criminal association."

The widening lodge scandal has led to the arrest of a former colonel in the Italian secret service and threatened Premier Arnaldo Forlani's 7-month-old coalition government.

Italian newspapers and magazines have alleged that the so-called "P2" lodge was involved in a variety of illegal activities ranging from bribery and tax evasion in the oil industry to a far-reaching plot to set up an authoritarian regime in Italy.

The names of top politicians, businessmen, publishers, diplomats and military officers were on a list of 953 lodge

members Forlani released to the press two days ago under pressure from Parliament. Two cabinet members were on the list: Minister of Foreign Commerce Enrico Manca, a Socialist, and Labor Minister Franco Foschi, a Christian Democrat.

Sarti, who has helped direct Italy's battle against terrorism, was not named, but documents found in the home of the lodge's grand master reportedly say he was a candidate for membership.

Sarti, in a letter to Forlani, denied he had attempted to join the lodge, but said he was forced to leave the government because his name had been tainted in a "slandorous campaign." His resignation was announced after a 15-minute meeting with Forlani, a fellow Christian Democrat.

The Italian constitution prohibits secret associations, and if the P2 lodge were in fact secret, membership in it would be outlawed.

On Friday, Milan prosecutor Pierluigi Dell'Osso issued an arrest warrant for Grand Master Liceo Gelli on charges of political espionage and the procuring of information on state security. Gelli is listed as a fugitive outside Italy.

Antonio Viezzer, a former section chief of the Italian secret service, was arrested Friday on political espionage charges.

A parliamentary committee investigating the case has said it suspects the lodge helped stage the phony kidnaping of Italian financier Michele Sindona in 1979.

(NOTE: A synopsis of the above clipping is that the Italian "P2" Masonic Lodge involved over 953 well known Masonic businessmen, publishers, both the Christian Democrat and Socialist parties, the Italian Secret Service, and the Labor Ministry, in an oil industry scheme to set up an official corporate-state fascist regime like that of Mussolini.)

Admission into Masonry requires a belief in "Almighty God", which comes as a surprise when considered in light of esoteric mythological information, related to the origins and meanings of the myths of "The Holy Grail", "Lucifer", and "Jesus". The word "grail" ("Graal") comes from the language of the ancient Albigensians (Al + bur + gen + si + ans = "El-Barrow-Born-Sun-People"), in which "Gorr-" + "-aal" means

"Holy Stone of El" ("El" being Saturn ["Sa-" + "-turn" = "Sun-Hare", meaning Osiris] or Lucifer ["Luci-" + "-fer" = "Light-Hare"], or Satan ["Sa-" + "-tan" = "Sun-Dawn"]).

As the myth goes, when Lucifer—also known as the "Morning Star"—fell from heaven, a sacred green emerald (the "sacred stone of El") fell from his crown. This was the "Holy Grail". From it was supposedly carved a cup known as "The Holy Grail", which was searched for by the Nazis⁷ in the vicinity of the ancient Pyrenees stronghold of the Albigensians, whom they regarded as their "ancient Aryan spiritual forebears". The Albigensians were burned at the stake (the "Pyre", hence "Pyrenees"), 700 years earlier, by the Catholic church. The Nazi Ahnenerbe defined its mission as being to avenge the ancient wrongs done to the Hyperborean ("O-pher-bore-an", or "East-Port-Barrow-People") Cathars ("Ca-" + "-thars" = "Quay-Hares").

The Christian religion was designed by Josephus⁸ (A.K.A., General Arius Calpurnius Piso), on behalf of the ruling Roman elite—who were Hermeticists—to replace the old Arrian (Aryan) religion, in which Osiris was the main god. Jesus was created literally as a replacement for Lucifer, to become the "Messiah" for the 'new' religion for the "Age of Pisces". Since the (five-pointed) morning star (Venus) which was the symbol for Osiris (Lucifer), was also to be the symbol for Jesus, Josephus made Jesus to be called, "the bright and morning star"⁹. That means the Christians worship Lucifer, disguised as Jesus. That Lucifer really is a deceiver!

It became apparent to me that only the government could have financed and run such an operation, and that only they had the motive to do so. Only the corporate-state O.S.I. conspirators had almost unlimited funds and financial motivation to invest in such an endeavor. It was indeed astounding that an O.S.I. agent whom I had known for years, had confirmed his connection to the Secret Government, and attempting to recruit and employ me in the fabrication of tacky CIA "alien" trash, to hoodwink the American people, by concealing the advanced technology on behalf of the IllumiNazis. Maybe the cult was financed by the dope smuggling, minus a fat salary for Jim.

Our government creates and promotes hoaxes, backs fake propaganda movies and T.V. specials, and harasses anyone who threatens to expose them, more to conceal energy secrets, rather than to protect aeronautical or weapons technology. This is especially directed at anyone engaged in research or inventing within the field of "free energy" or "perpetual motion". If anyone categorically doubts the feasibility of perpetual motion devices, I would like to introduce you to my real friend, the Universe, which, like an atom with its perpetually orbiting electrons (as a rule and not an exception), is a perpetual motion machine. Nobody created it, nobody can destroy it or make it disappear, nobody can stop it from working, and nobody can show any 'external' source of energy which runs it. It has no "gas tank", no beginning or end, and will never die. It is too big to have been "created", and if it were finite, what would it look like on the outside? The S.E.C. cannot prosecute the Universe "out of business". Scientists who are incapable of conceiving of the infiniteness of the Universe, and can only conceive it with a "beginning and an end"—like Rebecca of Sunnybrook Farm—are inferior and limited thinkers who shouldn't even be in the field of science.

⁷Jean -Michel Angebert, *The Occult and the Third Reich*, McGraw-Hill Book Company.

⁸Abelard Reuchlin, *The True Authorship of the New Testament*, Abelard Reuchlin Foundation, Kent, WA98064.

⁹New Testament, Revelations 22:16.

"UFO" groups—actually O.S.I, counterintelligence teams—falsely create the illusion that occult groups are responsible for cattle mutilations—by coordinating their activities with the inadvertent reports of saucer sightings and the discovery of mutilated cattle by the public. Meanwhile, the government also disseminates other false propaganda through "official sources" like the Santa Fe District Attorney's office, such as through the federally-funded \$50,000.00 grant for a phony "investigation" conducted by former F.B.I. agent, Ken Rommel, in which the government investigated itself. The purpose of this "investigation" was to feed propaganda to the pseudo-skeptical "Official Government", Philip Klass/CSICOP side of the phony debate, to protract the misinformation through continued confusion and false conflict.

We the People—supposedly the damned 'bosses'—are "not yet ready for the technology" (the ostensible excuse for the over 50 years continued secrecy, proffered at NSA/military/O.S.I./Air Force oversight intelligence committee levels). But what about the bankers and corporate IllumiNazis who in reality determine national—and international—security policy? Isn't it they who are "not yet ready for the technology"? Is this the ultimate Wag the Dog scenario, or what?

There is traditionally a quasi-Nazi orientation of state police in America, which is often interlocked with the CIA. In Texas, as a Neighborhood Commissioner for the Boy Scouts in 1962, I attended a scouting executive conference hosted by the Air Force at Big Spring. For some unexplained reason, everyone started speaking German. Most of the Buffalo Trail executives were of German or Nordic extraction.

The keynote address for the conference was to be delivered by the head of the Texas Department of Public Safety, Col. Homer Garrison. Also in attendance was (then Capt., later Col.) Wilson Speir. As I waited in the "air room", before Garrison's address, Col. Speir approached me and unexpectedly said, "Adolf Hitler was the finest Christian gentleman the western world has ever seen, except he made only one mistake, by failing to kill all the Jews." After the conference, I was placed on the mailing list of several anti-Semitic, Nazi-oriented publications, such as Conde McGinley's Common Sense, of Union, N.J. I never paid a dime, and the paper continued to reach me no matter where I moved, until 1966. Many policemen like Speir apparently admire Hitler because they consider him to have been "a good cop", who "cleaned up the streets of Germany". Police work sometimes naturally attracts authoritarian types who think that an authoritarian state will diminish crime and improve life. And imagine: A state in which the cops would be "top dogs"! These are not good cops. They are "bad cops".

Another thing this experience confirmed, was the Nazi orientation of the Boy Scouts, similar to the transformation in Germany of the Pfadfindern ("Pathfinders", the German equivalent of the Boy Scouts), into the Jugendbunds ("Youth Bunds"), from which the S.S. Hitlerjugends had grown. In Austin Texas, in 1968, a Boy Scouts of America T.V. ad was narrated by one of Wernher von Braun's N.A.S.A. astronauts, John Glenn, now a U.S. Senator from Ohio (and the oldest astronaut to go into space). The ad showed Scouts on patrol, carrying patrol flags, running up a hill and tumbling down the other side, as a vaguely familiar German military march played in the background. I recollected having heard the march only a short time before, in a televised documentary of William Shirer's Rise and Fall of the Third Reich. In the documentary, a Hungarian composer and favorite of Hitler—affectionately referred to as "Putzy"—related how he had composed a march entitled Youth Marches Forward, on request of the Fuehrer, for a propaganda film for his Hitlerjugends. John Glenn gave his

recruitment spiel to American youth, and the ad with the march was a verbatim copy of the Nazi ad. After I pointed this out to a few people at the university, the ad was promptly jerked from the media without public comment.

The same Col. Wilson Speir (previous page) who was a Scouting official, and eventually became head of the D.P.S. in Texas, after the death of Col. Homer Garrison (ca. 1966), was given a special "heroism" award by President L.B.J., in 1967. Despite the numerous inquiries of Senator 'Babe' Schwartz of Galveston, no one could figure out what Speir had supposedly done to earn it. Schwartz probably knew of Speir's Nazi proclivities, and was just 'turning up the heat'. One of the first things Speir did when he took over the D.P.S., was to create the state police's very own "mini-CIA". The first thing to come to my mind, was Himmler's S.S.. How deeply in law enforcement has this influence penetrated?

In 1986, a young Atheist scout was kicked out because of his refusal to believe in a "god", or to pledge loyalty to "God", as stated in the "God and Country" phrase in the Boy Scout Oath. Asserting his right to religious belief or non-belief, he brought suit to enjoin the scouts to reinstate his membership, alleging not only the un-American, illegal and unconstitutional discrimination against him because of his beliefs, but also the abridgement of his 2nd Amendment rights to protection against state recognition of an establishment of religion. He lost the suit and the U.S. Supreme Court upheld what they referred to as the "right" of the Boy Scouts of America to discriminate against Atheists. A taxpayer-provided federal highway marker on 1-25 to the south of Santa Fe, directs the public to a local Boy Scout meeting hall, as official sponsorship of the Scouts, who discriminate against Atheists, just as they might do against Jews. Ergo, the state officially discriminates against Atheists.

It is disturbing to think that these Christian fascists equate only their religious beliefs with "good", while the beliefs of "Atheists" are automatically associated with "evil". Perhaps someone should have told them that "Satan", to an Atheist, is purely a mythological creation which belongs to the Christians and Jews. The Communists only pretended to be Atheists, but in reality, substituted a different pantheon of gods (their leadership), under a different set of mystical beliefs, replacing the myth of "god" with the myth of "collective consciousness", the same as the Tibetan Bonpas.

Atheism is inconsistent to totalitarianism, since Atheists are by definition individualists who reject both Christian, Communist, or any other mystical collectivism. Without blind acceptance of what a totalitarian government or religion tells you, based on faith rather than reason—such as the idea of a "collective consciousness"—as the basis for a "more just", "more scientific", or "superior" form of government or society, a collectivist system breaks down. There is nothing in the world's major religions to prevent them from practicing communism or fascism, which are based on the same kind of altruism. In fact, wherever these religions have become the "state" religions, the results have been communistic or fascistic. Many people like Stalin, merely exchanged their priestly garbs for communist or fascist uniforms, without even breaking stride. Fidel Castro was converted to Marxist-Leninism by two Jesuit priests, while in the Sierra Maestas of Cuba, preparing for his final march on Havana.

I have found nothing in the lives or works of such famous Atheist as Giuseppe Verde, Mark Twain, Thomas Edison, Nikola Tesla, Nathan Hale, George Washington, Abraham Lincoln, and many others whom you might never suspect, to urge anything other than a free system, including the right to believe as one chooses, upon others.

Many of our most famous Atheists have been forced by circumstances to pay "lip service" to Christianity, Judaism, or other religions, including Communism, in public statements, coerced by corporate fascists who consider the mind-control mechanisms of "collective belief indispensable to the security of their coercive "systems".

It is easy to be confused when the government spreads false propaganda among a public willing to believe it. A 1953 panel was set up to "investigate" flying saucers, headed by Dr. H.P. Robertson—an O.S.I. consultant, chosen to head the Robertson Panel—which eventually issued what was called The Robertson Report (on "UFOs"), intended to embellish the cover-up which has been protracted until today.

The N.S.A. (parent agency to the O.S.I.) is known in the "trade" as "The Puzzle Palace"¹⁰. A 'puzzle' is something that comes in bits and pieces, but "puzzle palace" implies a place where puzzles are created, like a "pizza palace" creates pizzas. Through "false puzzles"—the pieces of which fit together to form false pictures—the public is misinformed in such a way that they believe they have pieced a puzzle together, and "...figured something out", when in reality they were suckered in by the O.S.I. These "puzzles" might lead a rational person to conclude that the scenarios are too corny to believe, but the religious history of the world shows that 'mass' society is hooked on corny scenarios, especially "religious" or "spiritual" ones. O.S.I. think tanks—guided by the S.S. mystics of Reinhard Gehlen's RSHA—have designed these phony 'alien' scenarios, using the principles of secret, mystical movements, societies and religions of the world. This technique was influenced by the fact that, in the creation of librettos for grand opera, composers and librettists know that successful librettos must be "schmaltzy" (Yiddish for "chicken-fatty", but meaning "corny" and overdone). This conclusion influenced the modern Big Lie Technique, as stated by Adolf Hitler:

"In the size of the lie there is always contained a certain factor of credibility, since the great masses of people...will more easily fall victim to a great lie than to a small one, since they themselves...lie sometimes in little things... Thus such an idea of an untruth will not at all enter their heads...therefore, just for this reason, some part of the most impudent lie will remain and stick ".

Sometimes determining the truth is just a matter of common sense, being a good judge of character, and at other times, objectivity in listening to the ridiculousness of what is being said. You sometimes know the truth because it is reasonable, is being told by a calm, sane, reasonable and honest person, unconnected to the government, who is not given to flights of fantasy, corroborated by other reliable sources. People who say they "met space beings" (p. 133), are either government liars, attention seekers, insane, or pathetic victims of slick government cons.

Why do these liars have such illegal power over us? We shall know the truth—which is a pack of CIA lies. The 1979-80 "investigation" by ex-FBI agent Ken Rommel, reported in the New Mexican, is immediately refuted by a letter from Thomas Martin of Santa Fe, as shown in the following facsimile news clippings from the New Mexican (ca. 1980):

¹⁰James Bamford, The Puzzle Palace [1982],

Investigation says mutilations caused by scavengers

Details of a year-long investigation into New Mexico's mysterious cattle mutilations, summarized in April, were released Monday and point to animal scavengers as the cause of the mutilations.

Former FBI agent Ken Rommel, who conducted the probe, concluded that most of the 117 cattle deaths he investigated were caused by natural causes and damage to the carcasses was caused by natural predators.

The report supports conclusions outlined by Rommel in April and adds details.

The 297-page report, prepared for District Attorney Eloy Martinez with a \$50,000 federal grant, includes reports from veterinarians and others and photographs of damaged cattle.

"...I found nothing in the official reports to indicate that the animal was mutilated by any agents other than predators and scavengers," Rommel wrote. "Available evidence strongly suggests that those animals died from natural causes or common injuries and were subsequently ravished by scavengers."

Rommel claims that in 117 mutilations he investigated since 1975 there is not one case which could be described as a "classic mutilation."

Rommel's report claims that data obtained from qualified investigators and experienced veterinarians in other states confirms what he discovered in New Mexico.

"In fact, I have found no credible source who differs from this finding, nor has one piece of hard evidence been presented or uncovered that would

cause me to alter this conclusion," Rommel's report states.

Though Rommel's first recommendation is not to spend more taxpayer's money to fund law enforcement investigations of this phenomenon, he said further studies by anthropologists, psychologists, sociologists, and other behavioral scientists could be "useful and revealing."

Rommel urged law enforcement officers to investigate future mutilations sufficiently to determine if the facts point to unlawful killing, butchering or stealing, and to collect evidence and testimony to support a successful prosecution.

Rommel stated in his report that he hopes his conclusions would end "rumors, theories and fears that some highly organized criminal activity or extraterrestrial conspiracy is responsible for these mutilations."

The belief that mutilations are being done as experiments by highly skilled individuals using precision instruments is unsupported by facts, Rommel said.

He termed the facts cited to support this belief as "at best questionable" and "involving incredible flights of fancy" in some cases.

Reports of organs being removed "with surgical precision," lack of evidence at the scene and the carcasses being devoid of blood were among reported findings Rommel said were erroneous or misleading. Rommel said he found many "errors of commission and omission" in official reports.

Disputes 'mutilations' report

I can't speak for the other 116 cases, but I happened upon one of Rommel's investigations. This case involved a 1,000 pound bull, "caught napping in a tree by predators." The "predators" in this case rode in a helicopter and obviously had scientific training in toxicology. They took the same tissues I dissected while doing graduate study in toxicology, but then I was limited by finances to use rodents, not the cattle of northern New Mexico ranchers. Tissues taken included brain, gastrointestinal, gonadal and six inch core of the liver region. Clamp marks were present on the lips, to facilitate

the removal of the tongue. I admired the surgical techniques, neat and without blood. The focus on

Rommel's investigation of this case was to investigate the possibility of purchasing the negatives of the pictures taken by local residents of the slain animal.

You should refrain from calling these cases "mutilations" and describe them as they are, lab animal sacrifices.

My questions are: Who is responsible? What environmental pollutant is being investigated? Is it of danger to us?

The real scavengers, the coyotes, didn't touch the carcass, but then they know not to mess with the CIA, LASL, USAF, etc.

Thomas Martin
Santa Fe

Some policemen are responsible to the people, rather than to totalitarian-like bureaucracies which direct them. One gutsy New Mexico State Police member, Gabe Valdez, of Dulce, New Mexico, who is both intelligent and truly courageous, took on the phony FBI/CIA "mutilations investigation" of ex-FBI agent, Ken Rommel, head-on. The following is my facsimile clipping, with photo of Valdez:

Trooper blames mutilations on massive conspiracy

By JANE SEAGRAVE
The Associated Press

DULCE - Five years ago, Gabe Valdez didn't believe in aliens from outer space. That was before the steely eyed state policeman witnessed his first cattle mutilation.

Now, Valdez says he just can't rule out the existence of extraterrestrial beings.

More likely, he says, a top-secret medical research project is responsible for the mysterious deaths of more than 90 head of livestock in New Mexico since 1975.

And despite skepticism from his peers, gentle chiding from his friends and an official report discounting his theories, Valdez refuses to be dissuaded.

"It doesn't bother me. I think they're ignorant," he says of his detractors. "It just makes me work harder to prove these people wrong."

More than a year after a former FBI agent concluded in a 297-page report that the "mutilated" cows were victims of natural predators, Valdez has vowed to get to the bottom of what he believes may be a massive conspiracy engineered by the federal government.

"There are some things I can't talk about now because they're under investigation," Valdez said in a recent interview at his home in this small community on the Jicarilla Apache reservation. "But one of these days it will break."

The 38-year-old career officer is not the kind of man one would easily scoff at.

Small but squarely built, he was named "officer of the year" by the state police in 1977, largely for his part in the armed capture of a first-degree murder suspect.

The only state police officer on the reservation, Valdez is often called on to break up fights in bars or intervene in domestic quarrels.

Valdez, raised the son of a Los Alamos janitor in the tiny northern New Mexico village of Cebolla, realized his lifelong dream when he joined the New Mexico State Police in 1969. The father of three young boys,

he speaks with the earnest conviction of a man who is used to being listened to.

He rarely drinks, lifts weights in his spare time and --until recently-- "never even though about" the supernatural.

"He's realistic, I can vouch for that," said his wife, Margie.

Valdez became involved in the cattle mutilation issue in June 1976 when a neighboring rancher reported a dead cow with what appeared to be strange incisions in its soft tissues.

On investigation, Valdez said he found a tripod-like imprint near the animal's carcass, resembling tracks that might be left by a helicopter landing.

Later, the officer received reports that an unusual orange light had been spotted by area residents around the time the cow died.

Although Valdez said he did not see the light on his first investigation, he subsequently has seen it "a lot of times."

"It goes slowly and then it goes quickly. It looks like an evening star, but it's orange," he said. "I bet at least 85 percent of the people in Dulce have seen it."

Ken Rommel, a former FBI agent, was commissioned in 1979 to investigate the alleged mutilations. He concluded in a June 1980 report that the livestock deaths were due to natural causes and that the "mutilations" were the result of scavengers.

To believe that the cows were deliberately mutilated, eh said, "would require a wild imagination coupled with an agility to totally disregard the facts."

Rommel also questioned Valdez' credibility, quoting an unnamed associate of the police officer as saying Valdez sometimes "sees things that are not there."

For his part, Valdez said Rommel failed to investigate true mutilations.

The report "looks very convincing because it came from an FBI agent," Valdez said. "But everything he put in the report was speculation."

"I really don't know of an animal that can handle a knife or break a leg

or put a clamp on a leg. You actually have to be a big fool to say that it's predators."

Since 1976, Valdez' name has been linked to the issue of cattle mutilations and he frequently is the first person called to the scene to investigate dead livestock.

Anticipating that his findings will be viewed with skepticism, he now "always try to take along credible people to the scent of these mutilations."

The mutilations follow a general pattern, he said. In most cases, the animal's rectum, sexual organs and tongue have been carefully cut out.

The incidents usually follow reports of the strange orange light and of helicopter noises. Valdez is convinced that aircraft are involved.

But concrete evidence has been elusive. Valdez said ranchers have tried repeatedly to no avail to catch a mutilator in the act.

"You can sit there for months and nothing will happen and you might leave for the night and they will hit you," he said.

Valdez is becoming increasingly convinced that the incidents are carefully staged to appear supernatural, but he won't say for sure.

"I'm not going to commit myself and say it's not a human force, but there is at least some human involvement," he said.

The explanation he favors is that the federal government is using cows in a top-secret, defense-related medical research project. Orange lights and other devices are used to confuse observers into doubting what they see.

If Valdez has facts to back up his theory, he isn't making them public.

But to the state police officer, the explanation isn't the product of a wild imagination.

"Who else is going to spend the money to hire an aircraft to kill a cow?" he asks. "Who has the damn money just to kill a cow and take its tongue. It's got to be the government. It's got to be something big."



***SKEPTICAL PATROLMAN** - New Mexico State Police-
man Gabe Valdez believes cattle mutilations are part of a
top secret government medical research project.*

Gabe Valdez said Ken Rommel didn't investigate "true mutilations", and engaged in "speculation". Rommel questioned Valdez' credibility, yet failed to name a source for a comment allegedly made about Valdez by a fellow state policeman, an apparent lie by Rommel to patch up his own damaged credibility. Valdez' statement---"You actually have to be a big fool to say that it's predators"---pretty much says it all. Valdez gets my gold star for rationally saying the 'mutilations' are actually a "top secret, defense-related medical research project." Flying saucer-borne particle beam weapons irradiate the cattle, and mobile teams rustle the cattle and remove tissue and blood to examine for reproductive and immune system damage, as the CIA's "O.S.I.R.I.S." front creates a sham Nazi "golden cup" effect.

The issues are whether the cattle are (1) being intentionally "mutilated" by weirdos (highly unlikely); or, (2) being killed and eaten by predators with scalpels for teeth (Valdez' "big fools" believe this); or, (3) being subjected to particle beam experimentation, exsanguination, and surgical extraction of tissue to analyze for ionizing radiation damage (the "MRA" under the circumstances). As I have already said, an Albuquerque scientist named Calvin Horn, among others, years ago found that a standard blood coagulant and a microwave chamber were used to thoroughly exsanguinate the carcasses (even removing traces of copper from the livers). A cauterizing scalpel (invented in 1938, for those idiots who are easily mystified by technology as old as I am) removes tissue in non-bleeding cuts, cauterizing as it goes. The blood and tissue are then processed and run through a counter to determine the number of cells affected and how. Since it's secret, you know it's illegal and bad for us.

There is also the compelling evidence of strange aircraft which are silent (not helicopters), glow orange, and, as described by Gave Valdez, "...look like an evening star." Some of these ships, incidentally, have been photographed up close, "in the act." After the cattle have been removed to a laboratory—at a secret government facility, or in the saucers themselves—and are fully processed, the carcasses are dropped from the air, so as to avoid tracks around them for investigators to find, though tracks may appear at pick-up locations. Some have been found lodged high in the branches of trees. As Tom Martin implied a couple of pages back, it's stupid to call these partial dissections, tissue samplings and experiments "mutilations", any more than one would refer to an apendectomy as a "mutilation", unless the surgeon is extremely incompetent, or insists on proving he's no "button-holer".

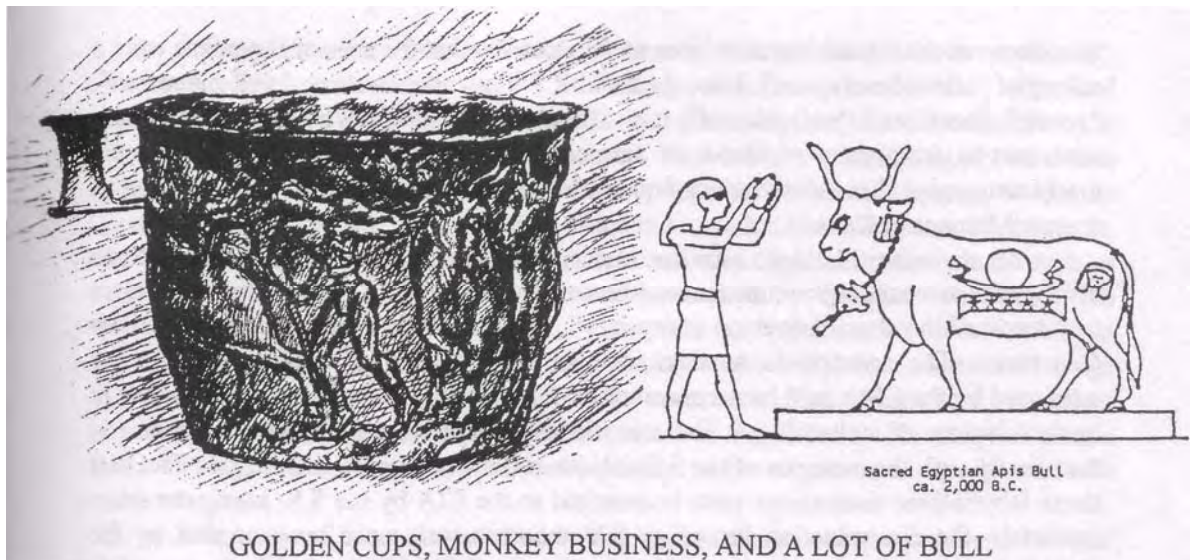

The golden Vapio Cups depict ancient Minoan "cowboys" of 3,500 years ago, rounding up bulls for the "pagan" ceremonies commencing important gatherings, in which such cups were used to drink the blood of young bulls. This "Golden Cup Ceremony" spread from Asia (Western Siberia), into the Mediterranean, and throughout the Celto-Nordic tribes, as traditions of the westward-migrating bands of mixed Norse, Mongols, and Moors. It appeared in the ancient Nibelungenlied ("Song of the Nibelungs", the pan-Germanic epic), became known as the "Holy Grail" myth, and was eventually taken up by both the Christians—who erroneously associated it with their religion—and by the Nazis, via their Ahnenerbe/Thule Societies, within the "Old Prussian" Masonic Illuminati, which revived the ceremony in neo-pagan Luciferian/Osirian Nazi S.S. ceremonial toasts to "knowledge" and "pure Aryan blood". This and the Egyptian Apis Bull myth are more fully connected in Chapter VII.

Then came the O.S.I, with its cattle mutilations cover-up, and covertly operated "O.S.I.R.I.S." pseudo-occult front group, to which they psychopolitically imputed responsibility—not to exclude the possibility that the ceremonies are actually those of Nazis perpetuating a secret S.S. infrastructure within the CIA—and daring us to catch them. Was not von Braun an Obersturmbannführer in the S.S.? Were any Blacks or Jews reported in these groups? "O.S.I.R.I.S." gatherings are coordinated with saucer sightings and related secret medical experiments ("mutilations"), to throw outside investigators off. The F.B.I.'s position is 'natural causes' for the experiments, and 'blackouts' on the saucers, while the Air Force's suspicious behavior lends false credibility to the cover-up conspiracy theory.

Seeking to rectify a blundering lack of visual arts finesse which was apparent in the original 1947 Roswell Hoax, the CIA now employs more skillful technicians, artists, and panels of Ph.D.s. In 1985, they warmed up the old Roswell leftovers as the "MJ-12" hoax, to retroactively fabricate a coverup in 1947. (There was a 1947 cover-up, but that was to conceal the fatal flaws in the hastily bungled initial hoax.) A lingering phoniness is obviated by the contorted, over-scholarly extremes to which they have gone, to create the effect that occult groups—with names like "O.S.I.R.I.S."—are responsible for the cattle mutilations. Oh, what tangled webs they weave, when first they practice to deceive!

Some of the related literature goes so far as to say that the ancient Egyptians were a colony of "aliens from space". Since the O.S.I.R.I.S. members were so "well-mannered", "young", "neat", and "well-dressed", it is difficult to imagine them hoisting up huge bull carcasses to drain them of blood, or surgically removing genitalia, anal tissue, etc., muchless gorging themselves on huge quantities of warm bull blood, like a lusty band of ancient Minoans or Celts.

As obvious titillations to ancient history detectives, arcane clues disseminated to mystify the surrounding circumstances (the work of the "Puzzle Palace") invite scholars to "uncover" the sham "cover-up conspiracy", not to mention the obscure Golden Cup Ceremony. The scenario is so devious, that only a team of diploma-mill Ph.D.s employed by the CIA could have conceived it! What better use for 'surplus' graduates in ancient history or archaeology? The scenario incidentally reveals an all too explicable familiarity with the esoterica of the S.S. Ahnenerbe dilettantes, considering the fact that these labyrinthine contortions were bequeathed to the CIA by the S.S. Using the same material—the dissemination for which S.S. theorists were once hung or shot by the Tribunal at Nuremberg—our own CIA, revealing its S.S. affinities, subtly brainwashes us with this garbage with impunity, in subliminal psychopolitical messages. We should be outraged that our government engages in this BIG BROTHER mystical, religious shamanism and huxterism, treating us like psychopolitical zombies; "Uncle Sham" at his worst!

In the ancient Egyptian religion, Hapi—one of the four sons of Horus the hawk or falcon—and one of the four kings of the cardinal points of the earth—is shown as a baboon-god which is the dual namesake for the 'Apis' Bull. The bull and ape are both forms of Osiris, the father and son of Horus, as part of early 'holy trinity' myth copied by Josephus. The military intelligence/Illuminati committees proffered up monkeys as aliens at Roswell in 1947, using the shaved and dyed rhesus monkeys (which are very close to the original "cynocephalus" ("Chinese-headed") baboons used by the Ancient Egyptians), to produce alienoid/humanoid-looking beings.

An examination of all this stuff makes it ever more maddeningly apparent that BIG BROTHER has been playing games with our minds, planting ancient Egyptian esoterica, either out of inherent bureaucratic plagiarism and uncreative laziness, or to dare some scholarly investigator to eventually discover it. Or did they think this was so slick that we mere 'civilians' would never unravel it? Was this an insider joke for Illuminati-employed Egyptologists, or just a short-cut for lazy Ph.D.s, who plagiarized their scenario from sources so obscure they mistakenly believed we would never discover how incompetent they were? Or, are the Illuminati who control the intelligence community so egotistical about their esoteric beliefs, that they insist on scattering the earmarks of them all about, as they gloat in secret pleasure?

"Apis" is Greek for "Hapi", the namesake for the "Apis Bull" ("Ape-Bull"), involved in the Golden Cup Ceremony ("Apis" contains the apparent root for "ape"). The sacred bull was chosen for a white triangle on his forehead, as another maddening Trilateral symbolic parallel! The bull was referred to as "Osiris Apas" (in Greek, "Osorapis"). Literally, this means "East-Hare-Ape-(Bull)", a sort of animal/god conglomerate typical of the Egyptian religion. So there is "O.S.I.R.I.S.", there are the apes, and the mutilations are the Golden Cup Ceremonies! Gee, I solved the Puzzle Palace's "puzzle of the month"!

Rhesus monkeys possess exotic, 'alienoid' characteristics—"cynocephalous", humanoid faces with large, soulful, slanted eyes—with subhuman body size, and similarities to the sacred baboon form of Osiris, convenient for transformation into the "space beings" of the Roswell/MJ-12 hoaxes. Furthermore, a handy supply of rhesus monkeys from the Regional Primate Research Laboratory, at Alamogordo (or its predecessor agency) were already being killed in the rocket sled accelerator experiments, as substitutes for human pilots, preparatory to manned flights in rocket planes such as the X-15, leading up to the moon missions envisioned by Wernher von Braun. The monkeys were already outfitted with the helmets and G-suits, to simulate human conditions as closely as possible. The original photos showed pressure lines and lacings visible on the G-suits, which would have been unnecessary had the monkeys been pilots of flying saucers, which canceled most if not all of the G-force. The original photos which I saw, now appear to be unavailable, except in the memories of myself and those who saw them.

When one of these shaved dead babies is dyed green, and you put his G-suit and helmet on, with those like DEAD eyes looking out from under those droopy eyelids, the effect is EERIE enough to convince some gullible people that they are "aliens". The dead lab animals were shaved, in order for the G-suits to be effective (the pressure with the animal hair would be ineffective). The total effect was in fact TOO WEIRD, and even the government bunglers eventually backed off from that one. The key words here are LAZY and BAD TASTE. The original photos showed the fatal flaws—identifiability of the critters as monkeys, and apparently man-made constuming and equipment—since aliens capable of traveling millions of light years through interstellar space, would probably not use conventional sewing machines and lacings to make their garments. Exposure of the 1947 fakery, exposes the ensuing protracted hoaxes. Ergo, the newly created (c. 1985) MJ-12 documents scenario, ex post facto, was also a hoax. The original hoax at Roswell was already out of the bag and had to be altered, since it was obviously bungled. A hoax to conceal a bungled hoax.

The major error in the original 1947 Roswell hoax, after the dead monkeys were all dressed up for the rocket sled, was in deciding to go ahead and give them "somewhere (else) to go", without more professional consultation. At that point, some G.I. with bad taste and judgment, probably said something like "...Yeah...that's it..that's what an alien would look like! Let's do it!"

Roswell was the largest town in the general area, the citizens of which had almost all seen saucers, or had close friends who had seen one of more. Because of the fantastic electrical flight characteristics and inadequate control and navigational systems of the earlier saucers, the government was unable to conceal them while developing them in the area. The hoax was an ill-conceived attempt to explain away the many sightings near the secret military bases, where excited post-war saucer experimentation accompanied the influx of German saucers and personnel, immediately after the war, soon followed by more. The hoax was intended to convince the many people who had seen saucers, that they weren't "ours".

The government had its hands full trying to keep the German saucers secret, what with the fifteen thousand German scientific, technical, support and security personnel. All those people had to have recreation, which created even more security problems. The German personnel often went down to nearby Juarez and Ojinaga, Mexico, to blow off steam and whoop it up. Naturally, some of them were arrested and held in Mexican jails

after all-night drinking bouts, whoring, and brawls. Getting foreigners out of Mexican jails has always been difficult, and the Juarez jail was a sort of old dungeon which was notorious for its large rats and bugs.

While at the University of Texas, I had a neighbor named Helen Nash. Helen was married to retired A.F. sergeant George Nash, whose father had gambled away the fortune earned with his grandfather's Nash Automobile Company. Helen was from Germany. She had an old ancestral castle over in East Germany, near the Czech border, which the West German government bought from her, since they figured sooner or later, the divided Germany would be brought back together again, and they would have 'title'. The old castle would make a fine tourist attraction. Now that's what I call thinking ahead. Helen's father owned all the pleasure boats on the Rhein. His main boat was called the "Barbarossa". That made me wonder just how far ahead the Germans were thinking. Anyone out there get that? Barbarossa ("Red Beard") is the Germanic myth about an old man who awakens from his slumber every so often, and comes out of his cave to stalk the earth. The myth is an esoteric Nazi code symbolic of the return of a new Hitler, in a Fourth Reich.

At 15 years of age, Helen, who spoke five or six languages, was brought to Alamogordo/White Sands from Bavaria, as a security agent for the German Operation Paperclip contingency of the secret flying saucer/rocket project. One of her main jobs was to negotiate with Mexican authorities, to get German scientists, soldiers, and other personnel out of the Mexican jails, and to act as an interpreter whenever necessary. She was like an extension of the German Embassy, very highly connected because of her aristocratic family. It sometimes cost a lot of money to get the Germans out of the Mexican jails. Helen never denied my accusations that the German contingency she worked with included the flying saucer group, but since she still held the rank of major in German Intelligence, she was still bound from saying more by security regulations. Helen was brought to White Sands as part of Operation Paperclip, while von Braun was at Ft. Bliss, and the entire German flying saucer project was brought to America, because the Russians were threatening to overrun West Germany, and superficially it was feared that they might acquire the technology, though it was more likely that the Illuminati was completely eradicating the "German memory" of the "KT-p2" Projekt.

The decision to execute the Roswell hoax was probably not previewed or fully authorized by the Pentagon, failing to anticipate that their Illuminati bosses would still be relying upon it 38 years later (in 1985, at the time of "MJ-12"). So the old, flawed hoax was buried, and the new revised MJ-12 hoax was created to replace it. No one has come up with the photos which were published not only in newspapers, but magazines as well. That means that, in the 47 years since, the spooks have continually combed the shelves and files of libraries, newspapers, magazines and publishers, and "retrieved" every last stitch of this evidence, except whatever might still be buried somewhere in someone's old pile of c. 1947-1968 magazines, newspapers or other effects.

Down in Roswell, on Mar. 25, 1994, the government liars and their agents and dupes, were ballyhooing up a "conference" over the "Roswell Incident", coinciding with the filming of the T.V. production, "Roswell". They have two main tourist attractions in Roswell. One of them is the "Roswell Incident" hoax, and the other is the "Billy the Kid" hoax. Recently, information has come to light that William Bonny (the "Kid"), was not killed by Pat Garrett, but died Dec. 27, 1950 at almost 91 years of age, in Hico, Texas, going by the name O.L. ("Brushy Bill") Roberts.

This was documented by Dr. C.L. Sonnichsen (Alias Billy the Kid, 1955, written for William V. Morrison). Dr. Sonnichsen was a well established historian, who was often published through the University of Oklahoma Press, other Universities, and some private presses. I met him twice, once in the printshop of Karl Hertzog, the typographer for the press of the University of Texas at El Paso, and a second time in Santa Fe, where he attended a Southwest writers' conference, and we had a very enjoyable supper together at the La Fonda Hotel. He was well-acquainted with my old friend, J. Evetts Haley, the western ("cowboy") historian, and with Tom Lea, the painter, muralist, and writer, who wrote and illustrated the book, *The Mustang*¹¹. You can imagine the reaction of the "Kid" aficionados at Roswell, as well as those at Ft. Sumner, where the Kid was supposedly buried, after being 'gunned down' by Pat Garrett. They weren't about to let 'revisionists' put an end to a good thing, since a lot of their tourist income and local color is tied up in keeping things the way they are. They too had conferences, featuring forensic experts from Los Alamos, doing computer analyses of photos of the Kid and Brushy Bill, etc., etc. But if you have an artist's eye, and casually look at the photos of the Kid and Brushy Bill, you can see they are the same person, separated by about 40 years. Roberts had over 22 documents proving his identity as "Billy the Kid". Ft. Sumner advertises the grave site and Kid museum on billboards all around the area. Oh yeah! That "Brushy Bill" thing sure was a hoax! The Illuminati and CIA also oppose such revisionism, because it threatens to destroys confidence in "their" false history.

Jesse James' cousin, Ola Everhard, of Lovington, New Mexico, let the cat out of the bag a few years ago, concerning the truth about the death of Jesse James. Among my childhood friends, were the great-grandsons of Frank James, ("Jimmy" and "Al" Schlosser), and the grandson of a Mr. Shea ("Seay", or "See"?), Tommy Mulcahy ("Mulkey"?). Shea had been in the Army of Northern Virginia. When Lee surrendered, Shea couldn't accept it, and joined Quantill's Raiders in New Mexico. That is where Shea became friends with the James brothers. Later, Shea rode with Billy the Kid in the Lincoln County Wars, and maintained his old friendship with the James brothers, as well as the Kid, for whom he had a good deal of respect. Shea's respect was not easily won, and I don't think it was completely due to the fact that the Kid (temporarily) used an Irish name, William Bonny. That was all explained by Dr. Sonnichsen. I always knew that 'Bonny' and the James brothers (Frank and Jesse) had died of natural causes, after living considerably longer lives than most. Frank James, a published historian, ran a profitable antique business at Valley Mills, Texas, near Waco, where he died of old age. His grandson, Jesse James Howard, raised in the Cimarron, attended the University of Texas in 1938, wearing buckskins, moccasins, beads, and long pigtails. In the '60s, he jokingly boasted that he had been the "first hippy" at U.T., in 1938. He was Jim and Al's uncle.

Mr. Shea and the James boys (who used the names Bounds and Howard) would get together on their favorite patriotic holiday, the Fourth of July. I remember them getting together 1947, at the Schlosser house across Tornillo street, in Kermit. Shea looked resplendent in his Confederate Uniform, which he wore on such occasions. The get-together was attended by Shea, Frank and Jesse James, "Brushy Bill Roberts" ("Billy the Kid"), and their descendants. I can remember playing with a boy named "Franklin D. Bounds" (named after F.D.R.), who was Jesse James' great grandson.

¹¹Tom Lea, *The Mustang*, University of Texas at El Paso Press [ca. 1961].

Many times, Jim and Al had proudly shown me Jesse's favorite rifle, an oddball caliber Winchester saddle gun, which hung on their wall. That gun had been used in the famous Northfield Minnesota Amnesty Raid. And of course, when we played "guns", Jim and Al would play Jesse and Frank, often arguing about which one played Jesse.

I remember on that 1947 Fourth of July, that, as Mr. Shea came striding down Tornillo street toward the Schlosser house, and I played in the front yard with Al, the three old men with canes—Frank, Jesse, and Billy—came in the gate. Al said, "Hey Bill, how'd you like to meet Jesse James, Frank James and Billy the Kid?" I said, "Yeah!", and, as the old men came by, I shook their hands, as they said "How-do, young feller", but Al's sister told his mother, and I was taken into the house and asked to promise to never tell anyone about the 'ghosts' I'd seen.

Jimmy and Al got severely reprimanded for telling me "too much", since Jesse and Frank may still have had prices on their heads at the time. Though I knew the truth, and was sworn to it, and despite the fact that I tried to cover for them by telling their mother that they had told me nothing, the boys were still whipped, even though their parents weren't "mean". The events of that day told me two things: It was true that Jesse James was still alive, and Jim, Al and I weren't good liars.

Frank James, whose family used the name Howard (not Jesse's family, as some thought), and Jesse James (whose family used the Bounds name) had been given secret pardons by the 'carpetbag' governor, Edmund Davis, of Texas. They had previously acquired incriminating evidence on a fellow carpetbag governor, Crittenden of Missouri, and blackmailed him into prevailing upon Davis to give them the pardons. The man shot by Bob Ford, in Missouri, was actually a notorious murderer, wanted "dead or alive", named Charlie Bigelow, who looked a lot like Jesse. It was he who was laid in the grave, at the "funeral of Jesse James", in 1882. James even helped carry Bigelow's coffin, and Bigelow's wife, posing as Jesse's wife, even identified the body for the coroner, as "Jesse's"! Unfortunately, Bob Ford was subsequently killed in a Colorado saloon by a James fan. Mr. Shea, over 103 in 1947, died at 104, in 1948. He had taught his grandson, Tommy Mulcahy, at the age of two, to recite every state in the Union and its capitol, as well as the Gettysburg Address and the Declaration of Independence. The old man had a great patriotic love of America, and was one of the few who knew the Civil War was not about slavery. Out of respect for my friends, I didn't reveal the truth about the James brothers until after their deaths. No one would have believed me anyway, and most won't believe me now.

Jesse James died of natural causes on August 15, 1951, in Granbury, Texas (on the Brazos River, about 30 miles southwest of Ft. Worth) at age 103¹². Billy the Kid (A.K.A. William Roberts) had died the year before, on December 27, 1950, in Hico, 195 miles west¹³. The two had known each other for over 89 years, and they were almost relatives. The James brothers had come together on July 4, 1947, to Kermit, to talk over the "old days", and to visit family members and their old friend Mr. Shea., and to celebrate Independence Day.

Why do I tell you all these old stories? What do they have to do with the "Roswell Hoax"? These stories have to do with all historical hoaxes, because they show that, as

¹²Dr. Charles L. Sonnichsen, *Alias Billy the Kid* [commissioned by William V. Morrison, 1955].

¹³C.L. Sonnichsen, *Supra*.

usual, there is often a true story behind the 'official' version. That is because societies have almost always been controlled by an elite, through such hoaxes and false history, such as, that Reinhard Heydrich was assassinated in Bohemia in 1942, Hitler shot himself in the mouth in 1945, Jesse James was shot in the back in Missouri, Billy the Kid was shot by Pat Garrett, John F. Kennedy was shot by a "lone gunman" named Lee Harvey Oswald in 1963, and an "alien saucer" crashed in Roswell in 1947.

In order to understand the "Roswell Hoax", one has to know a little about the local history, psychology, and vested interests involved. A whole culture has grown up in New Mexico around the Billy the Kid/Lincoln County Wars stories, as well as the "alien saucer" hoax. On the "old west" folklore, there are museums, 'experts', graves, historical plaques, conferences, historical reenactments and pageants, gunslinger contests, and annual celebrations, and would virtually have the same things on the "alien saucer hoax", if only they had laid the little dudes to rest in proper graves. (Instead, the researchers incinerated the corpses along with other dead lab animals, especially since the corpses were beginning to stink very badly while they were at the hospital). Rhesus monkeys, like humans, release their bowel contents when they die, so the G-suits were getting pretty nasty after a few days in the July hot desert sun.

It is the carnival/tourist-trap psychology of the dusty little town of Roswell, which the government has tried to key into, rather than the local military yahoos, in perpetrating the initial Roswell hoax, but the atmosphere of the 1997 "50 Year Anniversary of the Roswell Incident" gravitated—or perhaps ascended—to the level of & folk festival, with people coming from the countryside with all kinds of alien kitsch, folk art, food and beverage stands, bands, and RVs, in hopes of making a few dollars and to have a good time. Most of them didn't even break even.

In respect to the 'alien saucer' hoax, just enough false clues were leaked through covert means, to keep the Big Lie alive, while attempting to conceal the original hoax by retrieving evidence, like stealing my two photos, and buying Bart Wilson's photo. Hindsight is sometimes 20/20. If the government revealed its part in the hoax, or if someone comes along with physical evidence exposing it, the government hoax will be done for, but as for the "folk festival", I'm sure some Roswell entrepreneurs will come up with the idea of a "Great Roswell Alien Hoax Museum". After all, why should the Piltown Man hoax get all the glory?

The family of my brother-in-law, Paul E. Jette III, a coach at Mount Pleasant, Texas, were early Anglo settlers in the Roswell area. Paul's great-grandfather was John Blazer, whose mill was the site of a well-known skirmish in the Lincoln County War. Some of Paul's family lived at Mescalero, the location of Dr. Robert Goddard's rocket workshop. Paul III and my older sister, Ramona, took their honeymoon at Blazer's Mill, near Mescalero. Goddard, Willy Ley, and Wernher von Braun fired experimental rockets in 1935-37, from nearby Eden Valley. Paul and Mona rode to the old Blazer place in a wagon used on the honeymoons of two previous generations of Jettes, as well as by many others in the family.

Paul Jette, I ("Pop" Jette), married John Blazer's half-Souix daughter, shortly after 1900. He had been the quarterback for the University of Georgia when Knute Rockne of Notre Dame had thrown the first forward pass. He set up the first modern athletic programs in New Mexico, at the University of New Mexico in Albuquerque, and at New Mexico State University (then "N. M. A. & M. Univ.", set up with statehood, under Teddy Roosevelt's plan). Then he was the head of the I. N. S. Paul III's aunt was the

Army nurse present in Roswell when the so-called 'alien' was dissected. She had previously been a captured Army nurse at Corrigidor in the '40s, survived the Bataan Death March, and continued her work as a nurse at Roswell until becoming a Sister of Charity nun. Roswell researchers have been unable to locate her. I know where she is, but don't want her to be bothered by 'UFOlogists'. Her sister, Leona, told me about the rhesus monkeys in 1958. The sisters also remembered von Braun and Dr. Robt. Goddard, when they test-fired their rockets at Eden Valley, near Goddard's workshop in Mescalero, in the 1930s. A young unmarried German baron in his early twenties didn't escape the attention of the girls in the small town of Mescalero, of course!

Roswell hoax dupes said the 'aliens' had no teeth, only four fingers on each hand, had "suction cups" on their fingertips, and were "...not human". Their teeth had been removed because military personnel were being bitten while shaving them, and putting the tight-fitting G-suits on them. Their fingertips were nipped off, healing to suction cup-type configurations. Their ears were surgically removed so the space helmets would fit, and they were deafened because the roar of the rocket sled drove them crazy. Their thumbs were surgically removed to keep them from escaping from the rocket sled harnesses, or from ripping or grabbing at personnel. The little guys were usually crushed to death by G-forces in repeated rocket sled runs, or in one of von Braun's reworked V-2s, during tests determining the "GS" a human pilot might withstand.

The strength of these monkeys are several times that of humans for their size. (I know about that, since I have a scar on my right hand, slashed at lightening speed by a rhesus monkey at a circus. The nasty cut was difficult to heal, because of infection caused by the filthy nails of the monkey). The reports that the monkeys "weren't human", was absolutely correct, since rhesus monkeys are East Indian short-tailed monkeys, not humans. There was a switch from the more problematic rhesus monkeys, to easier to manage and more docile chimpanzees, around 1952, about the time of the first publicized rocket rides of the chimps.

Following my July, 1993 first edition, the general excitement created by UFOlogy groups and their begged question that the government "concealed evidence of the crash of an alien space ship at Roswell in 1947", Kevin Randle and Don Schmitt published yet another book, *The Truth About the UFO Crash at Roswell*, in 1994. At page 149, they state: "Even Schaffner admits that earliest launches of rhesus monkeys occurred in the early '50s. He found no evidence that monkeys had been used in 1947." According to their own documentation, the records of the Space Center in Alamogordo say the first use of monkeys in rocket launches was on June 11, 1948. Was this "...the early '50s"? And, these were records of "rocket" launches, not the rocket sled, which naturally preceded the flights of the monkeys in rockets, in 1948.

G-suits, helmets, face masks and oxygen supplies were required on the rocket sled for the monkeys, to replicate contemplated human conditions as closely as possible. In addition, acceleration on the rocket sled would take away their breath, and if the monkeys had died of anything except G-forces, the tests would have been useless. (Incidentally, my Albuquerque friend, Merrill Holste, invented the G-suit in the '40s, but the government stole it from him and pretended that a man connected to a large corporation had invented it.) Of course, if records could prove that the "aliens" at Roswell were rhesus monkeys, they would naturally be classified, since they could document the hoax, like my photos. I also remember seeing a film on the 1947 rocket sled tests using them, simple as that.

The most telling thing about Randle and Schmitt's 1994 book, is that they attempted to address a question without saying who raised it, in their statement that "another researcher" had examined the "possibility" of rhesus monkeys in a crashed V-2 or A-9 German rocket, as the basis for the "crash". I was the one who had raised the issue of rhesus monkeys, which was then distorted with the reference to a possible rocket crash. True to CIA form, they didn't advertise my book by mentioning it, because the CIA UFOlogists will only cite 'documentation' they created and control, but Randle and Schmitt looked kind of silly attempting to answer my assertion without citing its source. They got their facts wrong on the rockets too, because V-2s and other German rockets were tested from May, 1946 until 1952, at White Sands Missile Range, by von Braun and company.

Highly publicized books by OSI contractors shows the systematic evasion of my questions, and a persistent asking of the wrong questions. They fall into two irrational groups: (1) The group asserting an alien spacecraft crash; and (2) the group denying an alien spacecraft crash, but asserting an experimental weather balloon crash, and adding that UFOlogists are crazy because they believe in "alien UFOs". The UFOlogists have intentionally made it easy for the OSI pseudo-skeptics, by providing them with assertions and questions which make a denial look correct, except for the weather balloon lie, used to cover the initially bungled rhesus monkey hoax.

The Roswell hoax illustrates how our government went into a relatively remote area—such as the southwest was in 1947—and intimidated and slandered the credibilities of literally thousands of people, with lies that those who had seen saucers were liars, were crazy, were publicity-seekers, or were all those things. Rather than to endure ridicule, most people learned to pretend that they saw nothing, and that the sky was 'off limits' to one's credibility. To hell with Aristotle! Plato's 'Cave Analogy' was now "official U.S. government epistemology".

Not to diminish the importance of understanding the hoaxes concealing the saucers, there appears to have been other monkey business afoot at nearby White Sands Proving Grounds, under the "space program" being hyped by von Braun, as a propaganda tool to get funding for the rocket and the secret saucer projects. It is a little embarrassing to think that the rocket program is a part of the BIG LIE scheme, since the saucer technology is so much cheaper, durable, faster, and much more fantastic. In retrospect, the rocket program appears to have always been a mask for the flying saucer stuff, and a much more monstrous and expensive hoax than the Roswell hoax, having as its purpose the enrichment of the chemical and 'aerospace' corporations, to get their impetus behind the program, as well as to enlist their backing in the concealment of the saucer technology, thereby also fraudulently enriching the oil and automobile companies, and adding their impetus to the program. To paraphrase Hitler, "The State and industry are to be partners; one hand washes the other."¹⁴

In 1970, I met a newspaper writer at the Odessa American, in Odessa, Texas, where my sister Liz had once been the amusements editor. The writer's name was something like John Behmer. He had worked for several newspapers in New Mexico over the years. Since my reporter girlfriend had told him that I was interested in flying saucers, he told me that if I would come in, he would give me some old photos he had found knocking around in a dusty old file drawer of a southwestern newspaper, possibly

¹⁴Adolf Hitler, *Mein Kampf*.

in Lovington, New Mexico. The photos were the ones I mentioned which had been sent out to newspapers in the southwestern region by Walter Haut, the "P.I.O." involved in the Roswell Hoax. One of the photos showed three of the dead rhesus monkeys in their little G-suits and helmets, and the other photo showed the junky little fake saucer. The saucer was so small, the monkeys would barely have fitted into it, with barely room for one of them under the little plastic bubble canopy on its top. It was smaller even than the "Vril" types purportedly built by the Germans.

Behmer said I should be careful who I showed the photos to, since the security people had very thoroughly attempted to retrieve all of them immediately after the initial hoax, in most cases before they were published. Somehow, the two old 8" x 10" black and white 'glossies' had survived the purge, forgotten about until Behmer had stumbled across them among old papers in the bottom of the dusty old file drawer he was cleaning out, in a back room of one of the small weekly papers owned by the "Freedom Chain", which also owned the Odessa American. Although I had seen the photos published, along with a third one, in the distant past, and even had a magazine in my collection which had them in it, my examination of those actual, clear and full-sized photos, allowed me to corroborate the rumor that the "aliens" were in fact shaved rhesus monkeys, just as I had heard. Unfortunately, I haven't seen the photos or the magazine since 1974, taken by the CIA thief woman who was associated with Jim Parsons (the "M.I.B."), and who had also lived with the French CIA "UFOlogist", Jacques Vallee, for two years. In 1980, I found books in her personal library in her apartment in Santa Fe, which were stolen in 1974, along with the photos and the magazine, before I even knew her personally. It was obvious that she took the unrelated books for her private collection, while collecting the important saucer conspiracy evidence, such as the photos and my magazine, for the government. When I caught her with the books, she said "...ohh, don't you remember giving those to me?" I answered, "I couldn't have given them to you before I knew you, now could I?"

As an artist, I have been known for my ability to draw accurately from memory. I used to do many of my paintings that way, when I was in Austin. I did a series of large "genre" paintings (with 'ordinary' people in them), usually based on the Austin environs. I would often 'borrow' the face of someone I knew, if it seemed to fit well into the character in a painting. In fact, some of the faces I borrowed were those of some of my professors, usually in jest, in satire, or sometimes worse. One of my large paintings was about 5' x 7', entitled "Winos at 6th and Red River Streets". As one man exclaimed when he saw it, "Hey! I knows dat dude! He's da' one whut sells dem fishin' baits down by da' river, ain't he!" One of my professors was a little startled to find his face on one of the winos who was just rounding a corner to join his friends, with a bottle in a sack under his arm. Using my old skills, I will attempt to reconstruct the two photos.

Rulers of a corporate-state society perpetrate as many confusing controversies as possible, so that individual members of the public will become so frustrated to attempting to do their own thinking, that they will finally give up and accept the state's Big Lies, spoon-fed to them through a controlled media.

THE ROSWELL HOAX 'SAUCER'

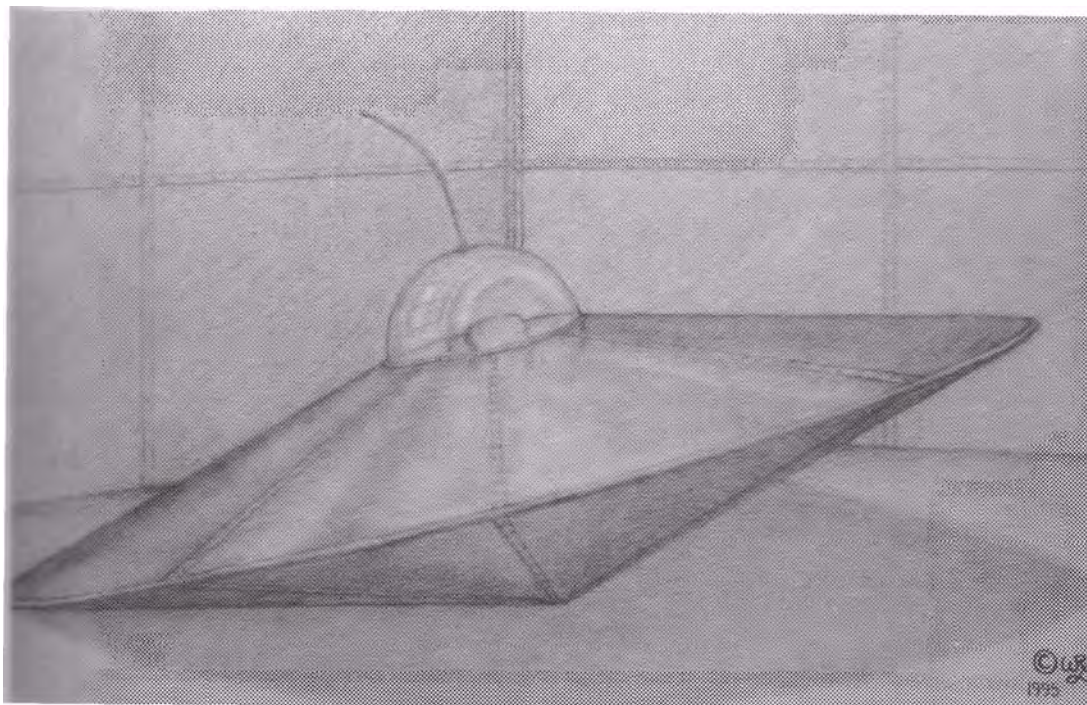

(NOTE: The fake 'saucer' was about 12' in diameter, and had a plexiglass bubble on it, with a slightly bent automotive radio antenna projecting above it. The rivets, screws, and stock aluminum parts were obvious. It was clear from the environments in which the 'saucer' and the 'aliens' were photographed, that the photos had been made before the 'crash scene' had been 'discovered'.)

The Intelligence personnel who created the hoax, were prohibited from disclosing classified information. Since the secret saucers they used on the bases at Ft. Bliss, White Sands and Holloman, were classified, they could not use one of them as an "alien" saucer. The fake saucer created for the hoax, was apparently the product of amateur metal workers, because the base where it was fabricated did not have a competent design or fabrication facility at the time. It was a pathetic failure, because, had it been an "alien saucer", created by an advanced civilization, capable of producing advanced technology capable of coming from light years away, it would have been even more advanced than the German saucers or early American prototypes possessed at the area's secret bases.

This early incursion into the special effects, prop-building and hoax-creation, by the "national security" spooks, was apparently a bitter lesson, which eventually led to them getting "professional help" from the movie industry labor pool. They not only produce much better hoaxes today, but have highly advanced cloaking and 'stealth' devices to conceal the saucers, such as special, color-changing surfaces, combined with color and image sensors, which make the saucers look like the background they happen to be hovering or flying in, similar to a chameleon. Anything for a buck, the sky's the limit.

THE ROSWELL HOAX 'ALIENS'

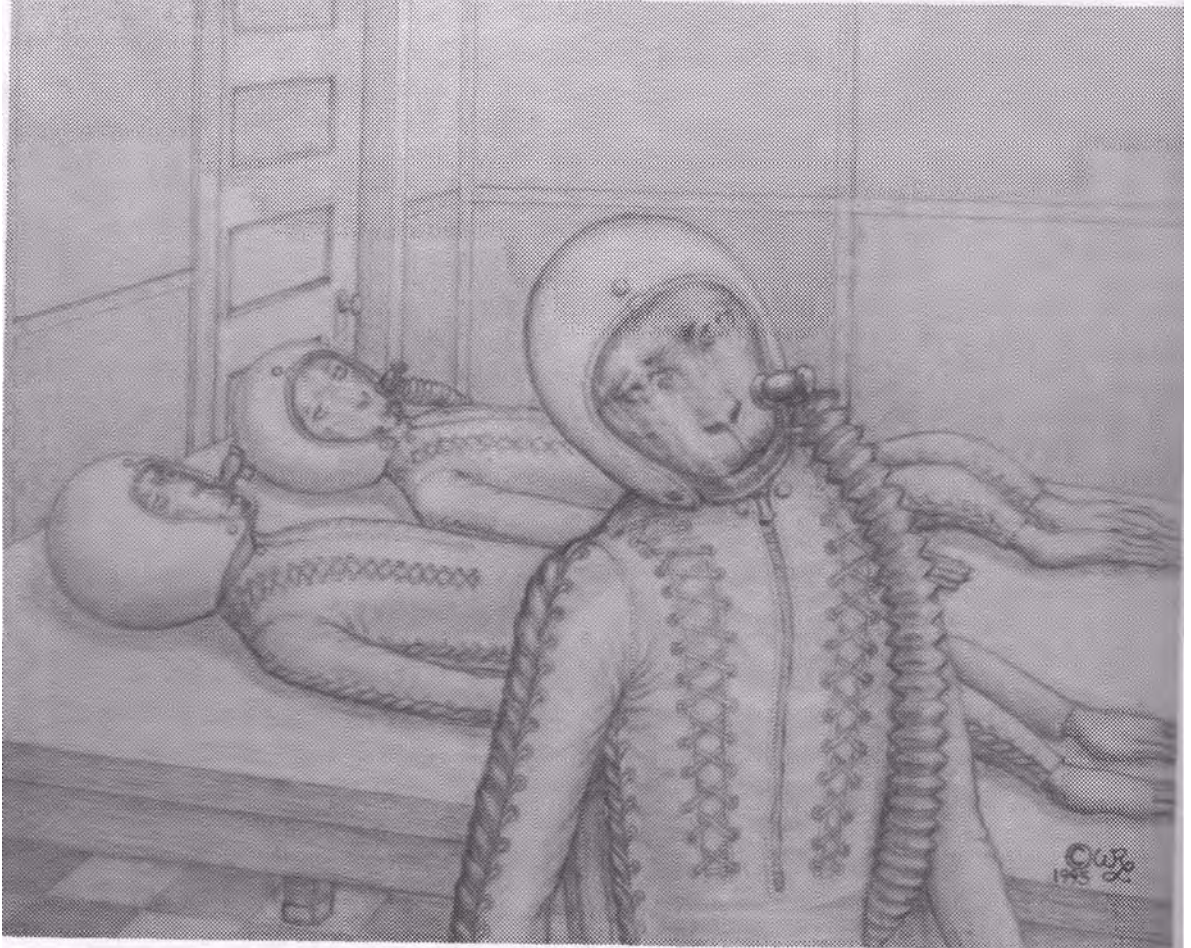

When a Big Lie is afoot, all who know the truth must be given a piece of the action, be discredited, or be eliminated. By maintaining a rocket program, the huge corporations and their employees are committed to supporting it, to acquiescing in the hoax which makes them rich, and sells very expensive rockets and chemicals at our expense. NASA propaganda is everywhere, especially in toy stores. An almost sacrosanct, religious aura surrounds this Nazi Big Lie. Playgrounds have 'space shuttle' toys to ride, 'science' TV programs instruct children on the Big Bang Lie, as if ultimate and immutable truth. This is no different than old Soviet 'space' propaganda, with posters everywhere, showing rosy-cheeked children building rockets in science classes, and colorful and heroicized portraits of "Soviet Cosmonauts".

I'm not an old crank complaining about "some of them new-fangled rockets". I'm complaining about archaic rocket technology, when we have the flying saucer, which belongs to us because we paid for it. It is tantamount to purchasing wagons and horses when we have trucks and cars, or cap-and-ball muskets, when we have AR-15s. Give us what we paid for, not some old piece of mediaeval junk which runs on crap dumped on us at exorbitant prices by the chemical cartels!

CHAPTER IV: SIGHTINGS

My purpose has not been to document an overwhelming number of sightings, in order to sell you on basic truths you should already be familiar with. A vast quantity of misrepresented or fabricated "documented sightings" is the province of the Big Liars and their dupes, while the real sightings are concealed or ignored. Project Blue Book has already buried more good information than I could ever uncover, or need for that matter, and chasing after such material would keep me busier than a one-legged Indian trying to stamp out a grass fire, just as they intend. The sighting I made in 1953 was the only one I needed, to absolutely confirm the existence of saucers in reality. In order for you to separate truth from lie, it is necessary to discern a predominant pattern exhibited by government "truth saboteurs", consisting of the following repetitive strategies:

1. Witness statements which are exaggerated, misstated, falsified, or obliterated; depicting witnesses as ridiculous, seeing things like "...little green men", or a saucer "two miles long", generally portraying them as "nuts", drunks, drugged, or hallucinating; this trick is contrite and easy to spot;

2. overstatement, misstatement, or entire fabrication of important physical data, such as a saucer which "...had fire shooting out all over it, with a strong smell of sulfur", or which was "transparent", "appeared and disappeared"; this creates confusion about how the saucer works, and fits in with "extraterrestrial origin" baloney, or alleged "hallucinations", "fantasies", "lies", or "mirages";

3. use of false, government-paid or procured witnesses, made to appear as private citizens, often thrown in when an important sighting is made, to confuse the public about what was seen, especially where an articulate witness manages to register a clear statement regarding what he or she actually saw. This pits one witness against the other, in a "war of credibility" which nobody wins, and "neutralizes" the truth. The press often has little alternative but to repeat false, conflicting reports along with whatever true ones there may be, or to print none at all;

4. use of government "experts", high-ranking military know-it-alls, or so-called "scientific" witnesses, often interjected to pose as the 'last word' on a sighting. This attacks the truth, by attempting to impress the reader with the 'high credentials' of witnesses who in fact saw nothing, for the benefit of dupes who are still too ignorant to realize that the government lost its credibility long ago, and that high-ranking ex-military 'experts' rarely buck the system and are liars, even when, as 'part of the plan', they may pretend to be doing so;

5. tampering in commercial film processing labs, which are easy prey for CIA thieves and saboteurs, as I learned long ago; you only get what they want you to have. The citizen who sends film exposures of saucers to such labs, will probably end up with blank, foggy, damaged, too-dark, tampered, substituted, or entirely missing images, the film may be stolen from one's camera, even before an attempt is made to remove it for processing (as in the case of the first roll of film I used to photograph Vicki Landrum

and her radiation burns, along with photos of my Peiltochterkompass and other flying saucer equipment).

My first photos of Vicki clearly showed the burns on her arms and legs. These were stolen from my camera by an expert, in Santa Fe, from my camera as it lay in my car, just after my return from Texas. I had to use surreptitious means to obtain replacement photos, and it was necessary to circumvent adverse influences of some of the members of my own family, who were being manipulated by the CIA, via the Masonic Order and U.S. Army Intelligence operatives. Such people may be caught in a conflict between obeying request from (what they think is) the Masonic Order, and concern for the life or well-being of a family member or close friend.

Witnesses are often astounded at what the media reports as their statements, but have no chance to correct these intentional distortions or errors, and usually fail to understand the subtle nuances or scientific reasons for such misrepresented details. Most witnesses are "little fellahs", whose 'day in history' may be transfixed by that one sensational, electric event. If it is made to seem fantastic at the outset, who is going to believe their attempts to correct the distortions?

VICKI LANDRUM, ET. AL.

An example of the 'little fellah' premise I laid out in Chapter I, Vicki Landrum is a persistent, consistent, sticker to the truth. I first heard of her story around 1989 or 1990, near the time of a hearing on her incident, in Washington, D.C. The news report I heard was made around nine years after the incident occurred. The incident stuck in my mind, not only because I have so many relatives in the area where it occurred, but because I had good reason to believe there was a better, truer, story underneath the usual distortions. Some trustworthy relatives had confirmed that it was 'real'. In fact, the government would be hard pressed to cover all the relatives and other reliable contacts I could martial in that area. At the time I contacted her, Vicki Landrum resided only a few hundred yards from my sister's house, and the saucer entourage passed through areas peopled by some of my other relatives. So, despite the phony version of the incident which I had recently seen on the "Unsolved Mysteries" T.V. program, I retraced prior investigators, and determined the purpose of their lies.

I sought out Vicki Landrum in late 1992, and had some trouble finding her, even with the assistance of some of her family members, including her granddaughter. Army Intelligence had already sent a man to check me out at my sister's house, even before I decided to contact Vicki. Once located, the situation I found was not a pleasing one. If Vicki Landrum was a "sensation-seeker" who persisted in her story for profit, as rumors had it, she certainly hadn't done a very good job of it. It was easy to spread local rumors, intended to taint Vicki's credibility or motives, or damage her economic standing in the community, and I found her to be a good woman, not so different from many of the people in my own family. Her health—and wealth—had been damaged by her own government, which had subsequently misrepresented and flaunted its irresponsibility, and trashed Vicki's dignity.

There was very little if any accurate information published on Vicki Landrum before this book in 1993, after which OSI writers and film makers quickly glommed onto her, to obliterate what I said, with more falsified or distorted descriptions of the

event. Since that time, Vicki has stuck to the truth and refused to lie like they want her toto say she saw 'little green men', "was abducted", or "suffered time loss". Because of this book—the first to expose the Big Lie Mind Control scheme to conceal saucer secrets—the Secret Government has had to rethink its strategy. They can't get around the Landrum/Cash sighting, because it was corroborated by so many other witnesses, and because the victims suffered real physical damage, and most of all, because Vicki hasn't played their game.

The place where Vicki lived was not a fashionable neighborhood, even for the area. It was a somewhat run-down apartment complex, the main office of which was gutted by fire. Some of the people there appeared to be of the borderline (if not actual) criminal type, and it was not a place for the faint of heart or weak of stomach. Neglected, dirty, ill-clothed children wandered about, as some of their parents sat in dingy and darkened apartments. After finding the burned-out shell of the office, I managed to locate the substitute office. I found Vicki only because I have conditioned myself to question everything. Everyone, including the manager, said she didn't live there, so I found her next door to a man who said she didn't live there and he'd never heard of her. Vicki's family was nice, clean, and quiet, out of place in the complex. The apartment was well lit and friendly, with family members cozily gathered about a table, engrossed in a board game. Vicki was a little guarded at first, but soon warmed up to me, because we had some common friends, including one of my old stump-jumping buddies, Richard. She was originally from nearby Louisiana, and was typical of many of her generation, having only a high school education, and a necessity to earn a living as a wage earner. Her fine looking husband was in his retirement years, having worked in harvesting and fishing for many years, and was still working.

In 1980, Vicki Landrum and her grandson, Colby Lee Landrum (then five years old), and Vicki's friend and employer, Betty Cash, were driving at night down a state highway in Betty's car, near Huffman, Texas, after leaving the store where Betty employed Vicki. They had the distinct misfortune of encountering a malfunctioning flying saucer, limping along just above ground, and accompanied by 24 U.S. Army Chinook helicopters, two by two, each sweeping the surrounding pathways with blinding searchlights, looking for potential witnesses and obstructions. The route through which the crippled saucer and entourage was moving, was a swampy, heavily forested, non-residential one, apparently chosen as the most clandestine route under the circumstances, en route to Louisiana, probably back to a base for repairs.

The Chinook helicopters—the large ones with twin rotors—were probably present in case the saucer should have to be "freight-'coptered" back to the base in a harness, in the event it became completely disabled, or may have carried troops necessary to cordon off and secure the area, in case it crashed. The idea also seemed to have been that, with so much commotion created by the 24 helicopters, with blinding search lights and blasting air, in the dark of night, who would notice the saucer?

Electrical energy leakage from the saucer's lower section enflamed the air as it arced to the ground. The helicopter engine roar, prop blasts, and blowing leaves were confusing, deafening and tumultuous, and the lights, flames and radiation created an eerie, frightening, dangerous, and disorienting effect, as the saucer landed on the narrow black-topped roadway, just in front of the car. Vicki grabbed her grandson and bolted from the car, only to be forced back by conditions outside which were even worse. In the few seconds that Vicki and five-year-old Colby Lee were outside, the metal of the car

had heated to a sizzling temperature. As Vicki reached for the door handle, her hand was burned. She then use a part of her plastic jacket to open the door, and it was melted. She still had the damaged jacket when I interviewed her. Vicki's hand print was still burned into the dashboard of the car, where she touched it inside. Only microwaves or electrical induction could have heated the car so rapidly and only penetrating radiation, such as ultraviolet, gamma or X-ray, could have caused the radiation sickness and resultant hair loss suffered by all parties, including Betty Cash, who didn't even leave the car. The following photo was taken to replace those stolen from me, showing Vicki Landrum and her burns:



The type of burns perceptible on Vicki's head, in this small photo, are all over her body. They were caused by Tesla's invention, as stated by him, in the article *THE PROBLEM OF INCREASING HUMAN ENERGY*, (*The Century Magazine*, June 1900):

"THE FIRST PROBLEM: HOW TO INCREASE THE HUMAN MASS - THE BURNING OF ATMOSPHERIC NITROGEN": "...The flame grew larger and larger, and its oxidizing action more and more intense. From an insignificant brush discharge a few inches long it developed into a marvelous electrical phenomenon, a roaring blaze, devouring the nitrogen of the atmosphere and measuring sixty or seventy feet across."

Vicki, Colby Lee and Betty all experienced microwave (infra-red) radiation burns over their entire bodies. The electrical discharges, which ignited the oxygen and nitrogen in the air, were probably responsible for secondary radiation in the form of ultraviolet or X-rays, which caused them all the total loss of body hair. Little Colby Lee—probably due to his tender age—suffered more severe radiation sickness, and had to endure a great deal of embarrassment and inconvenience, having to wear diapers throughout his elementary and most of his junior high school years, due to the acute and continuous diarrhea he suffered as a symptom of radiation sickness. The radiation burns on Vicki's body are still plainly visible. Colby Lee's diarrhea eventually subsided. At 19 he graduated from Dayton High School. They will suffer for the rest of their lives.

The 24 helicopters were corroborated by a Dayton policeman, a Mr. Walker, who, at the time of the incident, was near Crosby, Texas, where he witnessed the same passing convoy. Vicki has always maintained that she saw a government flying saucer and other aircraft, involved in an "...experiment which had gone wrong", damaging the three of them. Vicki was directly threatened by F.B.I. agents, and a Pentagon official, a Colonel George C. Sarran, who threatened Vicki, first in Washington, D.C., and later by phone, telling her to "...shut up or else...", with the further threat that unless she did shut up, she would be unable to earn a decent living again. (This same threat has often been used and enforced by our secret government against others, including myself.) The only 'official' person to 'appear' to lend any aid, was John Schussler, of N.A.S.A, in nearby Pasadena. He was purportedly fired for continuing to support Vicki's story, but the 'firing' was only to create cover for his new job with the O.S.I. shamsters, as a

disinformationist/pseudo-'turncoat' from N.A.S.A. Schussler was only conning Vicki and spying on her. His new job attempting to convince gullible people that the "aliens are here", uses his former N.A.S.A. credentials to create pseudo-credibility. Vicki was under the false impression that Schussler was her friend in 1992, but should know by now that he wasn't.

Texas senators Lloyd Bentsen and the late John Tower, managed to refer Vicki and Colby Lee for treatment at the Scott-White veterans' hospital in Temple, Texas, but they were so rudely mistreated there, that they were forced to leave. In 1985, Betty, Vicki and Colby Lee filed suit for damages. My facsimile clipping follows:

U. S. Contesting Lawsuit Over UFO Radiation

Houston

Three people suing the federal government for \$20 million say they do not know to this day what it was that hovered far over their heads and zapped them with radiation almost five years ago.

They claim it was an unidentified flying object that was escorted away by military helicopters. They say they suspect it was a secret U.S. Military experiment. In any event, they say, the government should have warned residents that a UFO was in their area.

The military says it had nothing to do with the alleged occurrence Dec. 29, 1980, on a rural road north-east of Houston. Even if there were UFOs, a U.S. attorney says, the government has no duty to warn people about them because the government does not know whether they are dangerous.

With such straightforward arguments, the government is urging U. S. District Judge Ross

Sterling to throw out a lawsuit filed here last year by former Dayton, Texas, cafe owner Betty Cash, 56, former waitress Vickie Landrum, 61, and Landrum's grandson, Colby Landrum, 11.

The suit claims that about 9 p.m. on Dec. 29, 1980, while headed for their homes in Dayton along a two-lane road about 30 miles northeast of Houston, the three encountered a brightly glowing craft the size of a city water tower. It hovered at treetop level, had red and orange flames flowing from its bottom, and bathed them in intense heat for several minutes before it was escorted away by at least 23 helicopters, they assert.

Their lawsuit, filed under the Federal Tort Claims Act, claims that the government failed to warn them of the UFO and "negligently, carelessly and recklessly" allowed it "to fly over a publicly used road and come in contact with the plaintiffs."

As a result, all suffered stomach pains, vomiting, diarrhea, radiation burns, deteriorating eyesight, and the women's hair fell out and grew back with a different texture, the suit claims. It also says they became highly sensitive to sunlight, suffered blisters and headaches, and that Cash developed breast cancer.

Despite the plaintiffs' report that there were no markings on the "large, unconventional aerial object" or on the helicopters, the lawsuit has recently moved from simply suggesting that the government merely knew about the UFO to saying that the government owned the UFO.

The government has offered affidavits from high-ranking officials that it had nothing to do with the UFO.

Dallas Times Herald

U.S. District Judge Ross Sterling (coincidentally, my distant cousin) dismissed the suit with the right to refile, and I believe it was refiled, and on last report, was still pending. Vicki's attorney, Clyde Ford, Jr., is married to my third cousin, though this fact does not necessarily mean I endorse him, though it seems that his work here has been commendable. He is a former professional with Convair, Atlas Missiles, and General Dynamics, an excellent background for a plaintiffs' attorney in this suit.

At the time of my second edition, Vicki Landrum, Colby Lee Landrum, and Betty Cash, had never been compensated, treated, or indemnified for their losses or injuries, which certainly related to the dire and mysterious circumstances as I found them. Who knows what future medical problems await them? The government, as the proximate

cause of the troubles, callously ignored and mistreated its victims, and breached its responsibilities.

In 1989, hearings on the incident were scheduled in Washington, D.C. Vicki, on their request, went to Washington for the hearings, at her own expense. There was only one brief hearing session, at which the government admitted that the operation was one of their 'experiments which had gone wrong'. All the remaining hearings were postponed and finally cancelled, as Vicki waited in Washington until completely broke, after which she returned home.

Based on my talk with Vicki, and Vicki's description and drawing, the saucer had a dulled, darkened, metallic surface (indicative of stealth technology), and was shaped rather like what Vicki described as an "ice cream cup shape" or "diamond" shape. Vicki's drawing, made on my request, placed alongside the same type saucer shown in some reliable photos, follows:

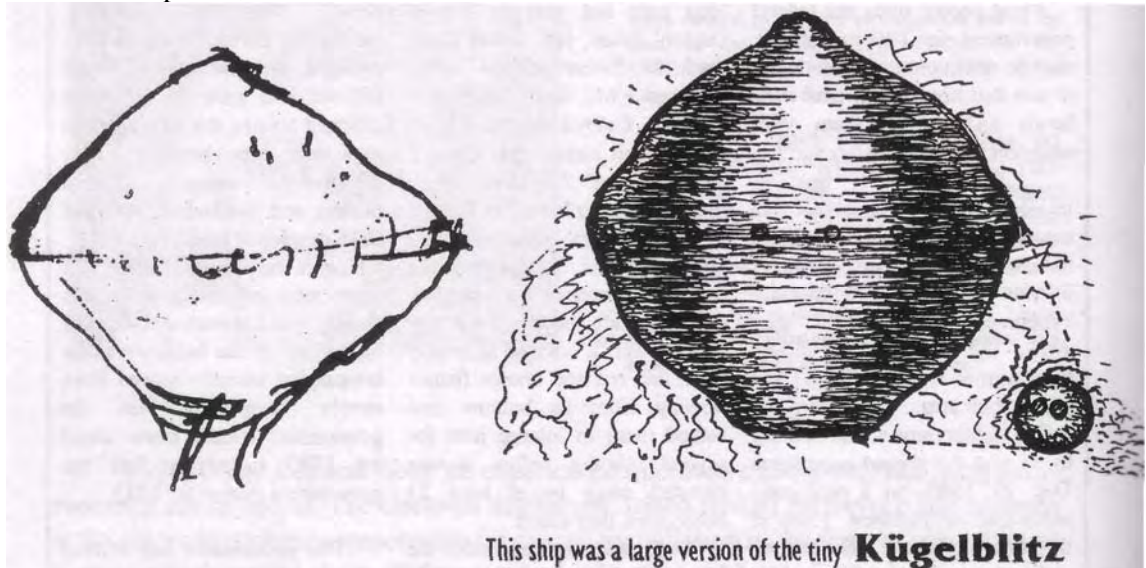

The use of Army Chinooks, when Air Force, Marine, and Naval aircraft were available in the area, suggests the "city water-tower-sized" ship was an Army or Special Forces troop-carrier, battle 'saucer', or ground weapons control ship. The air was inflamed by electrical discharges which, because the saucer was apparently malfunctioning, were being emitted from the bottom of the limping saucer, each time the pilot attempted power up to become airborne. The discharge 'leakage' about the bottom, which arced to the ground via Vicki and company—probably attracted by the metallic car—drained the energy required to maintain 'buoyancy', grounding and draining the electrical activity necessary to compress the ether carriers and block the gravitational effect on the bottom, to maintain proper flight of the already crippled saucer. The ship was probably experiencing internal dielectric breakdown of essential electrical components. The presence of the car in close proximity to its path, at the time it was crossing above the road, only made matters worse, by forcing the saucer to make a landing on the road, until the car was moved away from it so it could take off again. Under the circumstances, the pilot could not fly more than a few feet above ground, since further internal damage or a sudden loss of power at a higher altitude might have caused the saucer to smash into the ground with sufficient impact to destroy it and its

crew. They couldn't just leave it parked. The convoy should have been preceded by a scout copter, to clear the way and make sure civilians were not harmed.

The show which the T.V. production, "Unsolved Mysteries" aired on this incident, was false and exaggerated. Vicki never reported seeing "rotating lights" or a "spinning saucer" at all. The media also falsely stated that Vicki had reported seeing "little green men", or "space beings" through the "saucer's windows". This was an outright government lie. Vicki saw no windows. Red lights seen by Vicki were a horizontal row of stationary discharge electrodes, mounted in an annular line about the middle of the ship. These "lights" (actually emission electrodes) were activated in sequence, one after the other, in one direction around the ship, creating the illusion of rotation. These reddish pulses of current neutralize the "precession problem" I mentioned in the Introduction, by creating a rotation of counteractive force in diametric opposition to the precessive force, thus stabilizing a ship so the pilot has a steady view of the outside.

The government's covert Ufology lunatic fringe contingency tried to discredit the sighting for the benefit of their pseudo-skeptic counterpart, with the silly lie that the ship was an "alien flying saucer" being escorted to a "meeting between aliens and our leaders". (BIG LIE RULE NO. 1: MAKE THE LIE BIG ENOUGH). Such scenarios are often accompanied by fabricated environmentalistic bullshit, such as a desire by "aliens" to "bring us Earthlings to our senses", etc., because our "misuse of technology threatens the whole universe". Give us a break! If the entire earth or solar system were to suddenly vaporize itself in a thorough and complete nuclear explosion, the total effect would be less than that of a flea farting in a tornado.

It is also interesting to note that Whitley Strieber, in his books, or Budd Hopkins, in books such as "Intruders", never mentioned Vicki Landrum, et. al., even though Landrum said they had interviewed her. She said she adamantly refused to say "...what they wanted me to"—that she'd seen "aliens", been "abducted", or "suffered time-loss"—and instead continued to insist that what she saw were "government aircraft", (including the saucer) and nothing more. This was apparently the reason she was threatened, slandered, and never compensated for her health damage and losses, by our wonderful government. It is obvious as to how most witnesses are induced to say what their interviewers want them to, but not Vicki, a tough little lady who deserves respect.

RADIATION DANGERS

Regarding Vicki Landrum's radiation burns, the "flames" described by Vicki are 100% consistent with what Tesla described, as he developed this technology,¹⁵ as follows:

"THE FIRST PROBLEM: HOW TO INCREASE THE HUMAN MASS - THE BURNING OF ATMOSPHERIC NITROGEN: "...The flame grew larger and larger, and its oxidizing action more and more intense. From an insignificant brush discharge a few inches long it developed into a marvelous electrical phenomenon, a roaring blaze, devouring the nitrogen of the atmosphere and measuring sixty or seventy feet across."

¹⁵Nikola Tesla, The Problem of Increasing Human Energy, The Century Magazine [June 1900].

I should also point out that the public is grossly malinformed and misinformed regarding potentially "dangerous radiation". I suffered serious radiation damage after my 13th year, so I speak with some experience. In spite of the fact that I am 6' 3" tall, my growth was stunted in my lower legs by perhaps 4", by radiation. Sound crazy? Read on.

In 1951, in my 13th year, my father wanted me to take an "uptown job", outside our own business (which I sometimes ran when my family was absent). He wanted me to meet the rest of the "business community" in our town at large, beyond the confines of our own business sphere. That was the year my 'growth spurt' occurred. I got a job at a Dunlaps Department Store a few blocks away, sweeping up the store. During rest breaks, I would often go to the shoe department, where I would stick my feet into an X-ray machine used to check out shoe fits in vitro, studying the bones of my feet and toes. The machine was called a "fluoroscope", which used 'soft' radiation, tuned to cause the bones to fluoresce, and to produce an image on the screen, as one viewed his or her feet. During the time I did this, I apparently absorbed dangerous levels of radiation, which, as should be emphasized, were of the so-called 'harmless, softer' variety (i.e., below the frequency of "hard" X-rays, but above the general frequency of ultraviolet rays). Unbeknownst to me, the radiation was killing and mutating the red blood cell production tissue in the marrow of the bones of my feet and lower legs (remember what I said about the transmutation of elements below Atomic No. 19—such as calcium—in U.V. light?).

I soon began to experience so much pain in my feet and legs, that I had to quit the job. I lost weeks of school, laying in bed with strange fevers and leg and foot pain. I became anemic, had nosebleeds, and experienced several other related symptoms. The only explanatory diagnosis by local doctors for my mysterious symptoms, was "growing pains". I had to drop athletics for a year. My time in the 100 yard dash increased from 11 to 15 seconds. My lower legs became "bird-like", the objects of ridicule, as I struggled through my upper body, to make my sluggish legs move faster. My upper body continued to develop, making the disproportionate lower legs look even stranger. There was no medical connection made at the time by my doctor, as we were unaware that the machine at Dunlaps had caused my life-threatening symptoms. I still have problems from it, and have had discoloration around my feet and lower legs since my 13th year.

Though available to any kid or other person who happened to wander into the department store, the radiation was a dangerous, public hazard. Powerful cosmic radiation of very high frequency (the ZPR) penetrates our bodies all the time, passing even through the thickest lead. It passes clear through the earth without incident. Its frequencies are so high and wavelengths so small as to pass between the tightest of spaces within and between the atoms of even the densest of matter. It is when the wavelengths correspond to the resonant frequencies of our bodily atoms, that dangerous reactions occur. Relatively low frequency positive radiation of lowest energy, penetrates the clothing and flesh, and reacts with the calcium in our bones. The bone marrow in the lower body, in children, produces much of the red blood cells needed to maintain healthy life. As a child matures, these lower bones eventually stop producing blood cells, after which the bone marrow in the upper body continues to produce blood cells. At the time I was exposed to the Dunlaps fluoroscope, my body was already in transition to

produced in my lower legs. I came very near to dying shortly after the incident. As best I could determine, I crossed the danger line of 'radioactive relaxation', in 1977, 26 years following my exposure. This period varies according to the radiation involved, in respect to the particular matter excited by it, so this was just an educated guess.

Ordinary matter which has been 'excited' by powerful ionizing radiation, may show no detectable outward signs that it can 'relax' at some future date, to produce 'synthetic radioactivity' which is harmful to anyone near it. This is one of the reasons the F.B.I. conceals a book I mention below, and Los Alamos refuses to sell lead which has been used for radioactive shielding, along with the fact that lead shielding may contain some radium atoms (as well as gold) into which some atoms may have been transmuted, by absorption of high energy radiation, during experiments. Since radium emits gamma rays and produces alpha particles of around 4.5 Mev ("million electron volts"), the lead could be very dangerous.

Before 1892, a Frenchman named Gustave Le Bon wrote a book on "synthetic radioactivity"¹⁶. This book related to the use of ordinary, non-radioactive elements, to create nuclear reactions, thus opening the way for safe nuclear power generators. The book was among those on the F.B.I.'s 'retrieval list', in its 1942 sweep through all U.S. public libraries, book stores, universities, and even private collections and libraries. A copy of the book formerly used by and available to Dr. T. Henry Moray, in his local Utah public library, was confiscated by the F.B.I. in 1942.

In 1943, when Moray was attempting to reconstruct his radiant energy generator of the 1920's (the 50 kw one), he sought the book at the library, and was subjected to F.B.I. threats. Nonetheless, Moray was able to surreptitiously procure three copies of the book from a friend who was a book dealer, for his private library.

Le Bon's book related to techniques 'rediscovered' by me in the 1970s, as well as to the kind of radiation which almost ended my boyhood life for no apparent reason. Similarly, particle beam devices employing ultraviolet laser concepts, in the hands of Secret Government CIA maniacs, are in my estimation the basis for "stealth murder weapons" being tested on cattle, for which the 'mutilations' are their removal of tissue from the cattle to test for organic damage effects. Such weapons, tuned to U.V. frequencies, will disable a victim's T4 immune cells, can cause death by "terminal pneumonia", other related organic failures, cancer (by destroying p16 and p53 oncogenes), or tuberculosis¹⁷. This can also be called "A.I.D.S." or "hantavirus", since all these victims—including cancer victims treated with chemotherapy—once their T4 immune cell count drops below 250, will die of terminal pneumonia, brought on by "M.A.I." (Microbacterium Arium Intercellulare), the ordinary 'soil bacteria' we all carry in our systems. In healthy persons, these M.A.I. seek out and destroy cancer cells five times as fast as any known anti-cancer drug.¹⁸

Despite government misuse, "synthetic radiation" reactors—electric power generators using elements of low atomic number—are safer than any known means of

¹⁶Gustave Le Bon, *The Evolution of Matter*, publisher unknown [ca. 1890].

¹⁷Announcement by scientists, M. D. Anderson Cancer Center, Houston, Tex. [Jan. 20, 1994], concerning immuno-suppression by U.V. radiation.

¹⁸William R. Lyne, *Stealth I: De-Population by U. V. Immuno-Suppression*, *The Leading Edge*, Yelm, Wa., Issue No. 76 [Nov. 1994].

energy production, even coal or oil. My conclusions, based partly on my study of Blokhin's book (see bibliography), were further confirmed by my contact with an unnamed Mormon who experimented with and manufactured power generators based on Moray's generators. Unfortunately, Moray's theory and description of his radiant energy invention can't be trusted, as he apparently didn't know how it worked. In addition, he often used fake diagrams to conceal his work from prying government snoops, and the diagrams and drawings available do not provide so good an idea as my drawings do. Some of my designs combined ideas of Tesla and Moray, with some of my own. I conceived most of them independently, before I ever heard of Moray, whose plans bear no similarity to mine. I will give all these plans to the public in other books.

Though I created an "on-sale bar" for my universal rotary power transmission (Appendix A), by offering it for sale to the Japanese public in a 1991 newspaper ad, the appendix clearly bars anyone from patenting it.

My introduction to the 'unnamed Mormon' was mysteriously arranged by a man who sought revenge against the Illuminati, after they had arranged for him to be falsely accused, tried, convicted, and sent to federal prison for several years, for alleged S.E.C. violations, following the discovery by he and his friends of an ancient, revolutionary and simple piece of mining equipment, called the "Clute Machine", which had once threatened the Illuminati monopoly on precious and 'strategic' metals production and banking, many years before. After finding the old machine sealed away inside an abandoned Colorado mine tunnel, the group restored it to working condition. After news of their discovery leaked out to the Illuminati, the group was then Judas-goated into a criminally conceived and orchestrated federal entrapment scheme, involving the use of a federal con-man who wormed his way into their confidence. I will reveal the details of this simple machine in another book. It is already "public domain".

The typical coercive suppression of monopoly-threatening technology by the Illuminati, is carried out mostly under federal S.E.C. regulations, through judicial abuse which is seemingly unrelated to the technology it is used to suppress. When you think about it, this is practically the only convenient way for them to do so, other than outright brutal murder, which lacks the 'cover' provided by "color of law", though murder is at least more criminally honest and complete.

THE U.F.O. CLEANERS

In the early '50s, soon after WWII, my uncle, Angus Thomas Benton, Jr. ("Uncle A.T.") and his wife Ida, often watched flying saucers at night, as they patrolled the skies above the Intercoastal Canal, on the gulf of Mexico, within 20 miles of the Vicki Landrum incident, in Pasadena, Texas.

During the war, A.T. had been a crack anti-aircraft gunner on the U.S.S. South Dakota (rear left deck, beneath which a Japanese kamikaze plane crashed and exploded just beneath his platform, killing many of those below deck, as A.T. blazed away, during the "Great South Pacific Turkey Shoot"). Later, the U.S. fleet took possession of the Nagato Maru, Flagship of the Imperial Japanese First Fleet, in Tokyo Bay, in 1945. A.T. was sent aboard in charge of a five-man crew instructed to collect and arrange worthy souvenirs, from which the officers were to take "first pick". Always one to practice fair play, A.T. took his own first pick, including Admiral Isoroku Yamamoto's 'sea glasses', a giant pair of binoculars originally made and presented to the admiral,

practice fair play, A.T. took his own first pick, including Admiral Isoroku Yamamoto's 'sea glasses', a giant pair of binoculars originally made and presented to the admiral, who had a keen appreciation for photography and optical science. The glasses were one of twelve pairs made for the Japanese fleet, of which only seven pairs then remained, since the other five pairs had gone to Davy Jones' locker. A.T. dismantled the binoculars, threw away his clothes, wrapped the Nagato's battle flag around half the binoculars, and stuffed them into his sea bag. He paid his best friend to carry the other half, wrapped in his clothes. The Nagato was eventually sunk in the Bikini Island hydrogen bomb test, in the '50s,

Yamamoto (who purportedly died earlier in the war), with the assistance of an American-trained deaf mute, had used the glasses to read U.S. Admiral William F. ("Bull") Halsey's lips, as he gave commands from the bridge of his flagship, in an earlier engagement from which Yamamoto had wisely decided to withdraw. The binoculars could so magnify a person's face, eight miles away, that it appeared to be only a few feet away. One could also see the rings of Saturn, etc. A.T. and Ida used the giant woolen Battle Flag of the Imperial Japanese First Fleet, as a bedspread for several years (somehow in all this, there is the flavor of Bill Mauldin's Willy and Joe!). The souvenirs are now in the possession of my cousin.

After the war, A.T. and Ida started a cleaning shop in Pasadena, which they called the "U.F.O. Cleaners" (for "Undoubtedly Finest Offered"). A.T. placed Yamamoto's sea glasses atop the roof of his shop, where he and Ida watched the flying saucers at night, as they glided over the intercoastal sea lanes. A.T. said some of them appeared to have "quilted aluminum" on their bottoms. This apparently was the criss-cross ridge patterns of the early stealth technology, developed by the Germans during the wartime years for their U-boats, and adapted to the saucers.

Contrary to 'history', Admiral Yamamoto, Commander-in-Chief of the Japanese First Fleet, may not have been shot down over the western Solomons on Apr. 18, 1943, but may have secretly surrendered to U.S. Naval personnel near Guadalcanal, and been taken to a military jail in the Phillipines, where my neighbor, Antonio Sanchez, probably stood guard over him. When the admiral (Yamamoto?) told Tony in perfect English, that he was educated at Stanford, Tony asked him, "Then why you fight us?" Yamamoto (?) solemnly answered, "That was the most regrettable mistake of my entire career."

"STARS"

The most obvious sightings today, are right under your noses, if you live in certain areas of the country. For over 40 years, saucers have been 'placed' in the skies, locked into stationary positions by the inertial navigation system using the Peiltochterkompass, for use on the Nazi saucers as well as the rockets carrying neutron bomb warheads in the 1945 stalemate. The systems allow saucers to pose as 'stars' as they follow constellations across the night skies, testing new equipment and procedures, and performing experiments and surveillance on us. During the daylight hours, saucers are less visible, and are often concealed by heavy dark clouds which Dr. Wilhelm Reich called "DOR" ("Deadly ORgone Energy"). Such hoverings were documented in the early '50s by Reich, over his Maine observatory, using time-lapse photography with such skill that the government labeled them as "subversion" and "espionage". Reich's photos, which I have seen, revealed erratic movements of the saucers, in contrast to the

background constellations which produced consistently parallel, curved streaks of normal stars and planets across the film, as the earth rotated. Since at the time, use of the guidance systems on saucers was still under development, and since the saucers were so electrically unstable, their presence in the time-lapse photos was starkly revealed because they emitted a different light spectrum, and made brighter, 'smeared', meandering blurbs, cutting across the background of fainter stars.

Though Reich—an Austrian Jew—held some rather leftist views, he would have been immediately snuffed by the Russian Communists, and certainly didn't work for them. As a psychiatrist, he viewed sexual repression as the primary cause of fascism. His experiments on what he called Orgone Energy, were the basis for the government's abuse of process under which he was not only incarcerated under allegations of insanity, but also held under a conflicting criminal charge of contempt, for violating a federal injunction against his work, which it was alleged constituted "illegal medical practices", pursuant to F.D.A. regulations.

Reich claimed there is an "Orgone Energy" ("ORGanic Energy"), which is a naturally-occurring, life-sustaining, environment-permeating ethereal energy related to beneficial negative ions, and that Orgone has its antithesis, "DOR" ("Deadly ORGon energy") , a toxic, life-endangering, positively-ionizing substance , related to the 'free radicals' often associated with cancer and other diseases, and manifested in certain types of heavy, dark clouds. He invented a device called a "cloud buster", a trombone-like sliding, variable antenna, which inductively grounded the DOR clouds and "erased" them, conducting their death-dealing energy into a container of water connected to the antenna. Purportedly, the water was converted into heavy water (deuterium). Reich also discovered that his cloud buster could disable UFOs (a discovery which evidently led to his demise).

Reich claimed that, in the presence of great amounts of Orgone energy, his instruments detected dangerous levels of DOR around his laboratory, despite 'radioactive shielding', when 1 gram of radium was placed there in a thick lead container. He at first blamed the dangerous effects on the radium, until his discovery of the flying saucers hovering continually over his lab. This discovery inflamed the government, and marked Reich for death, perhaps because he had stumbled across government "death ray" experiments on the public (including Reich).

Reich claimed the DOR from the saucers was used to create desertification. On October 10, 1954, Reich disabled two UFOs. On October 15, his associate, William Moise, proudly presented Reich's findings to Colonel Wertenbaker, Deputy Commander, A.T.I.C, Wright-Patterson A.F.B., Ohio. Though Reich believed he had "made contact with aliens", he had "made contact with the Pentagon" instead. He had stuck his head right into a Secret Government meat grinder.

On November 2, 1954, Reich embarked on an experimental expedition to Arizona, where he purportedly proved that, by use of his "cloud-buster" to remove DOR being placed in the desert environment by UFOs, grass grew a foot high in previously desertified soil. On return from Arizona, he was arrested by the F.D.A. and jailed in Lewisburg Penitentiary, for violation of an injunction, and was found dead in his cell on Nov. 3, 1957, a week before he was to be released. His books, publications and scientific literature were banned and burned.

In the '50s I saw a film made of Reich outside his Maine laboratory, as he erased a DOR cloud over a nearby body of water and some trees, using his cloud-buster. To his

amazement, with the erasure of the cloud, a flying saucer was discovered hovering inside it. Reich's antenna apparently grounded the electrical system on the saucer, and it fell toward the ground, as he and his small film crew ran toward the downed saucer, knocking the camera over in the process and ending the film. The government has since stolen the film. The kind of saucer shown in it was of the same general type seen by me in 1953. It is my belief that either a "stealth ray-gun" or the corona discharges of the saucers creates the "DOR" effects observed by Reich.]

There have been many things written about Reich, much of which is disinformational. Though he made some important discoveries, Reich seemed to be unclear about what was happening, believing that what he was observing were "alien" saucers. It appears to me that Reich had either discovered a dangerous side-effect of flying saucers, or had discovered secret experimentation on the populace and the environment. I tend to think the latter is true, and I would not like to find out that saucers are inherently dangerous. I tend to think that the DOR was the product of intentional "population control" methods and "stealth weaponry" being tested or carried out on the general population and the environment by the Secret Government, since Reich was murdered to silence his investigation.

Saucers from Sandia and Manzano Bases usually proceeded to their initial night-time positions along my southeastern horizon, at about the same time each evening, in military fashion, despite the fact that sunset comes earlier in winter. The best visibility occurs seasonally, whenever the evening trips coincide with dusk...that time between day and night. In the brightness of full daylight in midsummer, a glowing saucer is invisible, while in the half-light of dusk, it is not only obvious, but usually shares the sky with no visible stars or planets to confuse it with. Many take up their positions right in front of cloud banks which are clearly visible along the horizon behind them at that time of the evening, before the darkness has caused the clouds to become somewhat transparent to the stars. It has always amazed me that people unquestioningly view these 'stars'—with clouds behind them—without realizing that clouds are never behind stars!

Saucers from Los Alamos (which is primarily engaged in scientific research), have usually taken up their positions further to my northeast, along the western slopes of the southern Sangre de Cristos, often over the outskirts of Santa Fe. Laser communications beams between the saucers and Los Alamos laboratories, can sometimes be seen, especially when there is mist or dust in the air. Those over the Pecos area to my east usually follow the constellations westward across the night sky where, after around 10 hours of flight, from positions just above the western horizon, they suddenly zip back to their bases just before dawn. The tell-tale things which obviate these saucers are: (1) The off-color (positive, ultraviolet) light spectrum on their bottoms; (2) the overall excessive brightness; (3) the 'hairy' (negative, infra-red) coronal brush fanning out from their tops; (4) the precession, causing excessive and 'overly regular' blinking; (5) the explosive, strobe-like flashes of electrical emissions from an 'anti-precession' stabilizing system (usually used when the saucers are moving slowly); and, (6) the bright red, green, blue, white and yellow emissions of laser communications devices.

These phony stars can be segregated from the real ones, by use of special photographic equipment, using spectrographic means to differentiate the radiation projected by them, or can be detected by amateur photographers by use of special films, filters and lenses, which are available commercially. Detection is also possible by digital

analysis of video footage shot with telephoto lenses. At night, it is usually difficult to make out the surface details of these saucers, because of the obliterating contrast between the bright surface corona and the black sky, which defeats the eyes. That is the reason the best photos have been made in bright sunlight, which penetrates the corona clouds and reflects back off the metallic surfaces underneath. Dulled, darkened surfaces have been used, but the saucers still show as obvious silhouettes.

The alarming degree to which many people have become brainwashed is demonstrated by the fact that these saucers are in plain view at night, yet most people ignore them, accepting them as 'normal'. Many younger people (below forty) have never seen the sky any other way. Yet, in many cases, the behavior of the saucers is so outrageous, that only a fool would accept them as "stars", "planes", or "helicopters". They hover for hours, blinking, wobbling, flashing, meandering, beaming out multi-colored lights, and often jumping or shooting around, while numbed-out, intimidated, brainwashed people refuse to allow themselves to believe there is anything extraordinary or unnatural about them. I once pointed a large one out to a neighbor, as it hovered over a nearby government bombing range between Galisteo and Santa Fe. We then drove from Lamy, to Galisteo, across a dirt road to State Rd. 14, up to Santa Fe, then back to Lamy. We drove completely around it, while continually viewing it, yet afterward, my neighbor refused to allow himself to believe he had seen anything other than a 'star', even after I explained how and why one cannot 'drive around' a star!

Another characteristic I noted while viewing saucers many times, as they flew right over Santa Fe at night, is that they appear to imitate small planes, but they seem to have a problem with moving at the speed of a normal plane. If they move too fast, they make brightly glowing, tell-tale streaks, so must move 'too' slow to disguise this (about 20-30 m.p.h.), below the stall speed of a light plane. Some of the strobe-like flashes are not stabilization systems, but are used to hide the faint glows of the saucers' hulls. Also, the fact that it takes a 'slow-moving' saucer too long to pass over Santa Fe, while making no noise, is another dead give-away, especially when a saucer just 'parks' for a half hour or so over the southwest outskirts of Santa Fe.

I once pointed a saucer out to a tenant, as it soundlessly approached Lamy low to the ground from the east, flashing its laser communicators, as it went down not over 250 yards away. The tenant, named Kroy Rubin, was totally unable to relate to the experience as being real. In a couple of days, I heard rumors that a nearby rancher—Joe Miller—had complained that 'dogs from Lamy', or 'coyotes', had killed some of his livestock, within a hundred yards of where I saw the saucer land.

Since publication of my first edition in 1993, the saucers normally visible near my home began to diminish, as the government began to exercise more discretion. More recently, the number of saucers is only a tiny percentage of what it once was.

Shortly after my first printing, I discussed this book with Joe Miller, while attending a small annual community flea market in nearby Galisteo. Joe said he had four young bulls mutilated at that time, which were 'bloodless', with the usual precise, cauterized cuts, etc. The bulls appeared to be air-dropped back into the pasture. The rumor I had heard—that Joe believed "dogs" had mutilated his cattle—was a completely false rumor spread by the O.S.I. Joe said that he had never suspected "dogs" or "predators", since the 'mutilations' were clearly of human, government origin, consistent with the findings of State Police investigator Gabe Valdez, who had performed the investigation. Not only had I and Kroy Rubin watched a saucer go down on Miller's

ranch, but had done so while it was either in the process of picking up Joe Miller's bulls, or dropping them back into the pasture. Since Miller is definitely among those like myself, who think Gabe Valdez has done a good job, he has been intensely harassed for over five years by the County of Santa Fe and the Sheriff's department, using any excuse. In 1995 they abused Joe and his wife, and eventually had to pay him considerable damages. The manner of continued abuse indicated that there was a concealed motive behind the abuse, which was not apparent from the circumstances, similar to how I was treated for so long.

I theorized a link between the legal abuse and Miller's corroboration of Gabe Valdez' investigation and theory, since I had been severely abused by the judicial and legal system under trumped up charges based on lies and tampered evidence, at the same time that ex-FBI agent Ken Rommel was conducting a mutilations 'investigation' through the Santa Fe D.A.'s office.

The multicolored laser communications system I observed on the saucer which landed on Miller's land was identical to what I'd observed in the mid south Atlantic in late 1974. This system on the saucers allows for multiple transmissions, as well as complex coding. Unless an observer is in alignment with the laser trajectory, he cannot possibly listen to it, or receive it, and then only if he has the special receiver. The combined or separate beams carry the coded or voiced communications, through modulations in beam intensity and intermittence. A receiver consists of a special scope with lenses, which receives and translates the beams, similar to an infra-red system. The communications system is very secure, outside of personal compromises, and traverses the problem of radio wave blockage or interference from electrical corona discharges from the saucer. The only draw back is the necessity for line-of-sight communications. Those having access are controlled by national security contracts, making them criminally liable and subject to severe penalties (even death) without hearing or trial, for a breach, under "national security laws". These procedures are unconstitutional, but the Trilateral Commission/Illuminati has never been hindered by that, and neither have the Masonic Order, the Jesuits, the Mafia, the K.G.B., the Mossad, or any other secret organization.

I observed this system in October, 1974, in the mid south Atlantic, en route between Savannah, Georgia, and Casablanca, Morocco, while aboard the Kraljevicka, one of the freighters of the Jugolinea, the socialist Yugoslavian national shipping line. Ironically, it was only a few days after I had met and shook hands with Trilateral Commission member Jimmy Carter, a former nuclear engineer and sub commander, as he campaigned for the governorship of Georgia, in the historic part of Savannah near the old Customs House, during a holiday, shortly before the November elections of 1974.

The weather was stormy on that passage, and since I have always enjoyed storms, I had walked out onto the left rear deck just after supper, to observe the sunlight, as it disappeared beneath a hole in the clouds toward the western horizon, on that October evening. I had been on deck for only a couple of minutes when I observed a flying saucer coming out of the clouds around a mile behind the ship. It took up and maintained a steady position, as it began to make laser transmissions, presumably to the ship's communications officer on the bridge. I observed these transmissions for around thirty minutes, before the saucer retreated back up into the clouds above it, as the golden light faded from the window in the clouds over the gusty sea. I sighed in amazement, then walked back inside. As I stepped into the hallway, three of the Yugoslavian officers

came downstairs from the bridge at my upper right. The first man—the communications chief—was pushing a little telescopic antenna-like projection in on what appeared to be a small electro-optical scope he had in his hands, upon which I saw what appeared to be calibrations, code letters, lenses, and sensors. As the three officers saw from whence I came, they immediately slowed, and looked at each other and back to the scope, as the officer sheepishly placed it in his upper shirt pocket, and they walked on by, shaking their heads and mumbling pursed-lipped good-evenings, with some embarrassment.

At that time, N.A.T.O. 'war games' were occurring. Though Yugoslavia was not a member, they conducted 'sympathy maneuvers', rolling their tanks and divisions into place along the Soviet borders facing Russia. I knew that a helicopter coming from a ship nowhere to be seen, would not have stayed so long, or come from so far away, or have been taking such risks in stormy weather, way out in the central South Atlantic. 1,100 miles to land in either direction. It should also be remembered that Tesla was a native of Yugoslavia.

Though the Kraljeviccka carried the red star of communism on its stacks, its crew and officers were at least 95% pro-capitalist. However, among all of the Mediterranean or Adriatic nations, socialist Yugoslavia was pitifully poor. Those lucky enough and enterprising enough to sail on the Judgolinea in 1974, had opportunities to engage in some profitable smuggling. For those not so inclined, it was like a sentence to prison, away from their families, with pay below that of their international capitalist contemporaries. One young officer, recently married, wanted to take his wife and defect, because he had spent only a couple of weeks with her out of his first two years of marriage. The socialist government required him to work for menial wages on the ship until he had 'repaid the state' for his engineering education. He was too naive and inexperienced to smuggle, but some young members of the crew were already making plenty of money without the benefits of a formal education, because of their 'supplemental' smuggling income. One enterprising young sailor, at the bottom of the totem pole, made fake soles for his shoes out of 'blonde Lebanese' and 'black Pakistani' hashish, wore them ashore and sold them, then brazenly waltzed back up the gang-plank in classy, new and dapper attire, and a pocket full of money.

The captain's pay was round \$4,000 per year, yet he was obviously a closet capitalist who supplemented his income similarly, on a higher scale, judging by his smooth demeanor, and the car from Santa Fe in which he arrive at the ship, just before departing Houston. I would tend to think "Russian icons", since I knew the car belonged to a Santa Fe art dealer I knew, of Yugoslavian descent. I recently—over 24 years later—met his cousin in Santa Fe, so I guess my assumptions were correct.

One young crew member, whose ambition it was to become a successful, American-style rock musician, had to wear long-sleeved shirts to conceal the "Young Communist Pioneers" tatoo which he had foolishly allowed to be put on his arm during his earlier years, later concealed in shame, so that other crew members would not point at it and jeer. Only a small number of passengers or crew were K.G.B. informants or agents, as was obvious from their sour and bitter dispositions, and the way everyone avoided them, or behaved hypocritically in the presence of. The young Yugoslavians were generally hostile toward domination by the Russians, and proud of Yugoslavia's long tradition of fierce and heroic warriors. The ancient pride and traditions of seafaring Anatolians could not be so easily erased.

It is unfortunate that in the past few years since the breakup of the Soviet Union, Yugoslavia has degenerated into a war-torn region in which ethnic and religious groups have slaughtered each other, and destroyed many of the beautiful and historic old cities and towns. The root of this squabbling appears to be instigated by the Illuminati, primarily through religious leaders, while seeing to it that plenty of arms are supplied from outside. This is not a tradition of which Serbo-Croatian 'warriors' can be proud, for only warriors who fight for freedom against oppression can be heroes. Shooting your neighbors and their babies, then raping and mutilating their wives and daughters, is not heroic, but yet another black page in history which one would expect to find associated with Ghengis Khan, Stalin, or Hitler, not with the Serbo-Croatians of today's world.

Since this book has stirred up a renewed interest in "government flying saucers" in this growing area, with several new subdivisions nearby, the Secret Government is now being forced by the publicity into finding other areas further away from encroaching population, since people seem to be rediscovering the validity of their own eyesight.

THE MIND CLEANERS

As you may have noticed, the "space alien" propaganda blitzes come in periodic waves, on a regular basis, to continually revive in your mind the corporate lie they have already planted there, that space aliens are "here". As long as we, the tax payers, through our government, continue to supply the money for the personnel, scripts, and productions, Hollywood will continue to use our funds to brainwash and deceive us, under the guise of "entertainment". Lately, the Official Big Liars have settled down to a single 'type' of space alien, which looks suspiciously like an old comic book type, which conveniently also looks like a small human being actor, outfitted with a more easily fabricated costume, mask, and makeup; this also looks like the rhesus monkeys of the "Roswell" and "MJ-12" hoaxes. The eyes are sunglass-type dark lenses, which conceal the actors' human eyes. This format was necessitated by the fact that some of the Old Big Lies had not only become difficult to fabricate in a convincing way (four arms, serpent skin, etc.), even for an increasingly more sophisticated audience, but also because a more "humanoid" type "space alien" format has proven to be more believable, and can be more easily faked by actors, makeup artists, costumers, and special effects technicians. The huxters can also point back to the corny Roswell hoax, minus the embarrassingly stupid photos, and, using the MJ-12 documents created in 1985 based on the 'standard' format, which harks back to the 'cynocephalus' rhesus monkeys of the originally bungled Roswell hoax. They have returned to the Roswell hoax, like dogs returning to lick up their own vomit.

The scenario has progressed much further out in Nevada's so-called "Dreamland", at Groom Lake, where the government has set up almost an entire base for this fakery. There are some highly classified projects under way at the base, but due to its weird terrain and obscure location, the government also uses the base for one of its special misinformation centers, perhaps to emphasize its need to conceal the projects. Security agents specially trained in the hoax—like Bob Lazar—convince their curious victims on the outside, that they are "ex-employees" of an "Area 51" top secret government project, and go through incredibly complex and expensive manipulations, to convince "specially chosen" (i.e., gullible) suckers, that they are attempting to "alarm the public" about how

"aliens from space are taking over". They drug the rubes, take them to a special part of their "secret base", and expose them to "things"—such as a fake little flying saucer with a tiny seat in it—designed to convince them that a small, non-human 'alien' had come to earth in it, so that the dupes will go out and "spread the word". Bob Lazar did this to a somewhat easy-mark gullible friend of mine, who is still unable to accept the fact that our government would go to such extremes to hide flying saucers being operated by it. The government even uses "designer drugs" in this brainwashing project, skillfully making suggestions under their influence, breaking down psychological resistance, and inducing very convincing hallucinations, while the victims remain unaware that they are under the influence of drugs. (Yes, I know what you guys are up to!) The fact remains that many people really want to believe such lies, right along with a lot of the other mystical baloney some people want to cling to, like an old Viking who can't stop swearing to Odin. The old Army "Mind Control" experiments support these hoaxes. That means that the U.S. Army and the intelligence community were probably conducting their original experiments for use on us for the CFR all along, rather than for use on any "foreign enemy". (See Walter Bowart's Operation Mind Control, and John Mark's The Search for the "Manchurian Candidate", for some more related background information.)

The basic thing drastically contradicting this scenario, is that anyone working in such a project—including Bob Lazar—would have a top-secret or higher clearance, and would now be in jail or dead, for violating the national security agreement they signed when their clearance was issued. He would be behind bars or worse, for merely confirming anything seen, known, or even suspected as a consequence of working there. This would happen especially if it were true that space aliens were visiting us, or were taking over. I signed a national security agreement in 1957, when I was only eighteen years old, and in those days, it was understood by most that the penalty could include an "executive termination order" (an order to assassinate a disobedient person).

Though I don't want to scare you, some unfortunates in the more distant past have been lobotomized, incarcerated in asylums and perpetually drugged or sedated, jailed in special prisons, illegally entrapped, falsely convicted and imprisoned, driven insane, crippled, given "dumb drugs", impoverished, had their marriages or families torn apart, turned into homeless persons or vagrants, totally intimidated, socially isolated, or had their credibilities ruined so that no one would believe them. Wilhelm Reich was arrested, incarcerated in an asylum, and murdered there. His arrest came only two days after a discussion he had with Einstein at Princeton, about his investigation at his Maine lab involving discoveries concerning flying saucers.

There seems to be more probability for legal protection today from the kinds of abuse which only a few years ago the government could get away with, while taking their impunity for granted, but the public is much less tolerant to such abuse today.

Consistent with Jefferson's adage that "the price of liberty is eternal vigilance", we must forever question everything concerning flying saucers, gravity, and "extraterrestrials", and realize that the Secret Government is responsible for endless misinformation, overstatement and understatement (the "untruth, the half-truth and the truth-and-a-half). We should question outrageous claims of personal experiences which are obviously fabricated by liars, drug-induced dupes, nuts, or secret agents, and remember not to confuse them with legitimate witnesses. Something like "...I met space beings..", does several destructive things. It discredits legitimate witnesses by

association, and thereby helps to conceal technology. If you have seen something which does not comport with accepted theories, and talk about it, be forewarned that "truth is stranger than fiction", and can damage one's credibility. Sometimes, too much truth, too soon, is more than most people can handle.

Insidiously, agents of the Secret Government pound away from every conceivable perspective. While some government fronts (mostly "UFOlogists") promote the paranormal, others, such as one led by Philip Klass, pose as debunkers, which I call "pseudo-debunkers", in support of the government, which 'officially' denies everything. Paranormalists, pseudo-debunkers, and government deniers form a triangle of withering crossfire, and triangles, as you should know, are strong, rigid shapes, unless they are composed of weak or brittle materials. Rationalists ought to occupy the side held by the paranormalists, who actually belong with the pseudo-debunkers, since their undisclosed ulterior agenda is the perpetuation of 'party-line' relativism (which Klass wouldn't dare have the guts to oppose), based on a Platonist epistemology. In truth, all three sides of the triangle are created and controlled by the O.S.I. The pseudo-debunkers are led by Philip Klass, ostensibly sponsored by the Smithsonian Institution, and Klass, the government spokesmen, and the paranormalists/UFOlogists are all restricted and controlled by the N.S.A./CIA/O.S.I.,

C.S.I.C.O.P. and the "pseudo-skeptic" movement, represented primarily by the Skeptical Inquirer magazine, and The Skeptic magazine, were created by the O.S.I./CIA to make inroads into the humanist/skeptic philosophical movement, and to covertly control it (as they had done with the Libertarian movement) because they correctly perceived a potential future threat from this quarter, represented by reasonable and analytical people like me. The following facsimile clipping, of March 9, 1991, (original in The Santa Fe New Mexican) announced a "debunking" lecture by Philip Klass, entitled "Bringing UFOs Down to Earth" (for which we already know what the conclusion was) as follows (emphasis mine):

UFO Expert To Speak Monday

A recognized **expert** on sightings of unidentified flying objects will give a public talk Monday at Los Alamos National Laboratory titled, "Bringing UFOs Down to Earth."

Philip Klass, author of four books on unidentified flying objects, or UFOs, said his talk will give the definitive answer to the questions: "Is the world being visited by **strange craft from distant worlds?** Or, has a large segment of the public, including **even experienced military and airline pilots, become unwitting victims of myth and their imaginations?**"

Klass is a **founding member** of a group called **Committee for the Scientific Investigation of Claims of the Paranormal.**

The talk is scheduled to begin at 3:45 p.m. Monday, March 11, at the Physics Building Auditorium. The auditorium is on the first floor of building 215 in the lab's main technical area, about half a block west of Pajarito Road, south of West Jemez Road. A large wooden sign on Parajito Road shows where to turn.

The "questions" asked by Klass were really statements, in which he purported to arrogate to himself what "...even experienced military and airline pilots" saw, presuming that they were "...unwitting victims of myth and their imaginations." These pilots fly—almost every day, for thousands of hours, for thousands of days. What would they know about what they see? When you board an airliner, you place your life in their hands, but if you believed Klass, you would never ride an airplane again! Experienced pilots have years of training and experience interpreting what they see—weather patterns, cloud formations, other aircraft, velocities, directions, etc., etc.—and military pilots are trained to identify other aircraft and their flight characteristics very specifically. What do the hell do they know? Why, Philip Klass, who flies his CIA desk all over the world...in his dreams...knows more than the pilots do, right? The following facsimile clipping, from the Associated Press, concerns some reports of the 'unwitting victims' (emphasis mine):

Air force tracking UFOs

BRUSSELS, Belgium - This country's air force has joined scores of Belgians befuddled by **hundreds of UFO sightings across night skies in recent months.**

In the latest report, **two air force F-16 jet fighters used their radar screens to track an object that, according to a military official, "exceeded the limits of conventional aviation."**

Speaking at a news conference Wednesday, Belgian Air Force Col. Wilfried de Brouwer said the UFO dived from about 10,000 to 4,000 feet in two seconds. At the same time, it increased its speed from 600 to 1,100 miles an hour.

The Associated Press

What do these Belgian military officials, fighter pilots, and hundreds of reporting witnesses know about what they saw? Phil Klass knows better than THEY do, by golly.

Flying saucers are seen by pilots with good eyesight, flying in their vicinity—up in the sky—often from above. Klass has made a "paranormal claim" here again, that hundreds—even thousands—of separate people (including professional aeronautical experts) have "mystically" seen the same things, at the same times. And some of these people were airline pilots, military pilots, radar operators, etc.—recognized "experts" in what they do, which is flying, controlling, and identifying aircraft (really a bunch of bumbling amateurs, in comparison to Klass, wouldn't you say?).

These were not members of some fanatical religion, witnessing an "apparition of the Virgin", etc., but certified, professional, experienced, aeronautical experts, required to pass high level visual and spatial perception tests, who are constantly tested for signs of psychiatric problems, whose experience is relied upon by thousands of people. Klass, on the other hand, has YEARS of experience, in his CIA office, of imaginary flights in his DESK, which, I'm telling you, really does some aerobatics, by golly (only in Klass's imagination).

Klass completely evaded the point, addressing only the allegations of paranormalists, as if they are somehow the ones mystically "chosen" to see flying saucers. Klass's allegations were completely unsupported by "physical evidence" that the people who reported the sightings were making any paranormal claims, or that they believe in anything paranormal whatsoever. By Klass's own standard, his claim was a knowingly false, fraudulent claim, more appropriately called a LIE.

Who is the "unwitting victims of myth and their imaginations"? Klass definitely fits the mold of his own statement. C.G. Jung would call this a "projection" (of Klass's mental fixation, neurosis, psychosis, or aberration, which he "projected" onto hundreds, thousands, or even millions of other people, as if it were THEY who in fact had his problem). Klass (and his O.S.I. mentors) sociopathically chose the paranormalist element—which had absolutely nothing to do with this situation (except they were created by the CIA, the Nazi SS RSHA, and Hans Horbiger) because it represented a weak and irrational position—a 'straw man', set up to be knocked down—intentionally "designed" to give 'mystical' and irrational significance to particular events. Thus the CIA covertly created the opening into which their pseudo-skeptics inserted the 'wedge' of pseudo-reason.

The paranormalists were created by and are clandestinely controlled by the same "forked-tongued" O.S.I. intelligence agency which handles Klass, and harks back to Reinhard Gehlen's Amt VI SS RSHA, which formed the core of the new CIA/O.S.I. in 1946, and as such, was the Nazi 'standard bearer' of Hans Horbiger's parapsychology 'straw man' in this hoax. The Nazis were the designers and trainers of Klass' pseudo-skeptic C.S.I.C.O.P. program, which is more parapsychological than any of those who made the claimed sightings, because those of C.S.I.C.O.P. SAW NOTHING, because THEY WEREN'T THERE, and presented no evidence of paranormal claims.

As the following clipping shows, Klass drew a 'packed audience' in the 'captive audience' government town, Los Alamos. Most of the audience were instructed by their supervisors to 'be seen' at the lecture, 'or else', in military fashion. Too bad Klass couldn't wave his magic wand and make the burns and radiation poisoning suffered by Vicki Landrum, Colby Lee Landrum, and Betty Cash go away. That is "physical evidence" of the most severe kind.

Klass, pretending to rely upon an Aristotelian epistemology, contradicted himself, and dishonestly deceived his audience with false arguments which begged the questions that "UFO sighters" believe UFOs are extraterrestrial, that they believe in "ghosts" and

"the paranormal", and that they are 'chosen' because they believe in ghosts and aliens. These claims by Klass are "paranormal". Also, since Klass believes in a "supreme being" according to recent news articles, he is a "closet paranormalist", by his own standard. I certainly don't believe in ghosts or any other paranormal crap, but I have seen many saucers. These errors, which clearly show Klass's dishonesty, are the false assumptions upon which Klass's entire argument rests, and a false assumption used to win an argument by fraud, is an unforgivable crime to any true skeptic like myself.

In the second column, in which Klass refers to "physical evidence"—which he says is ALL man-made—he inadvertently admits that ALL flying saucers are man-made. Klass must deny that he has ever seen a flying saucer, because, were he to admit seeing one, logic would require him to agree with this book, based on the MOST RATIONAL ASSUMPTION. The following is a facsimile copy of the news clipping from the

Albuquerque Journal, which covered Klass's lecture in Los Alamos, as follows (emphasis mine):

UFO Sleuth Tells Audience Explanations Down-to-Earth

By Rex Graham

JOURNAL STAFF WRITER

LOS ALAMOS - Believers in UFOs hate Philip Klass.

During a colloquium Monday at Los Alamos National Laboratory, it was easy to see why. The Sherlock Holmes of the UFO world said craft from outer space simply don't exist.

In a one-hour talk at Los Alamos, Klass used sarcasm and careful explanations to deflate the authenticity of UFO sightings around the country.

In one case, several people hundreds of miles apart reported seeing a cigar-shaped spacecraft on March 3, 1968. Klass explains that a Soviet rocket that had been abandoned in space burned and glowed as it streaked across the Midwestern sky that night.

One woman who sighted the phenomenon claimed it made her dog shrink to the ground in terror. Klass said it was cold that night and the dog was

whimpering from the temperature, and explanation greeted with laughter from the audience of mostly Los Alamos scientists.

"There is not a single piece of physical evidence, a single piece of metal that could not have been made in this world...not a single photograph that will hold up under rigorous scrutiny," Klass said to about 300 people attending the special director's colloquium.

The auditorium has 182 seats, which were all filled. About 120 people sat in the aisles or stood.

Klass, who for 35 years was senior avionics editor with *Aviation Week & Space Technology* magazine, recounted what appeared to onlookers, pilots and UFO proponents as spacecraft. But he gave simple explanations of events that he said eyewitnesses filtered through their imaginations.

All UFO sightings can be explained, he said, as meteor fireballs, abandoned spacecraft burning up as they fall back to Earth, ball lightning, or even retail UFO kits such as hot air balloons with flares attached.

Klass spends 20 to 40 hours a week investigating reported

UFO sightings and is recognized as the nation's leading expert in critical scientific investigations of UFOs. He's written four books on UFOs, including, "UFOs: The Public Deceived."

"(Klass) is hated and detested by UFO believers," said Kendrick Frazier, editor of *Skeptical Enquirer* magazine, in a telephone interview from Albuquerque. "He comes up with powerful evidence to puncture holes in their claims."

In a June 1990 Gallup Poll of 1,236 adults, one in four said they believed ghosts, and one in seven said they had seen a UFO.

Klass said 98 percent of UFO sighters honestly think they have seen one.

He reserves caustic criticism for authors who fan the flames of UFO mythology.

In a review of a book titled, "Out There: The Government's Secret Quest for Extraterrestrials" by former New York Times reporter Howard Blum, Klass unleashed his trademark blasts. "Blum has written a book that is essentially fiction and labeled it non-fiction," Klass said before his talk at Los Alamos.

It is evil how Klass systematically mixes indisputable facts—such as, that we know of no thing which is not man-made (second column, paragraph two)—with the begged questions of paranormal claims not made by the "sighters", and which Klass could have no knowledge of, because he had no evidence to support such a lie, and would have produced it if he had it. As for the "cigar-shaped spacecraft" sighted on March 3, 1968 (column one, paragraph four), the shape of such an object, seen high enough in the sky to represent the point at which it entered the atmosphere, would not be visible as "cigar-shaped." Besides, I myself have seen similar craft.

On the evening of January 26, 1996, at the Ten Thousand Waves Japanese Health Spa, on the western slopes of the Sangre de Cristos Mountains, above the city of Santa Fe, at approximately 7:00 o'clock p.m., as I sat in a hot tub with several others, I met a young woman who had read my book, just as I spotted a "blinking" aircraft moving slowly above the mountains, about 10,000 feet above our position. I said to her,

"Speaking of flying saucers, there's one right there," as I pointed to it. A heckler across the tub said, "Aww, that's a plane." I answered, "If it's a plane, then why did it just park?and there's another one right there."

As everyone looked at the two "blinkers", which had just "parked", I said, "The reason for the flashes is to conceal their underlying glow, which you can't see because your eyes don't have time to recover between flashes. When they move faster, they glow brighter, which is why they are going so slow."

At that very moment, the ship on the left lit up a dark green, soft glowing color, as it took off in a large circle which took it right back to its previous position, where it stopped on a dime, and returned to its small, "flashing aircraft" mode. As it was flying in the circle, I asked, "Does everyone see that thing?", to which they all said "Yes!", as I followed it with my arm and pointing finger. It took about ten seconds, and the circle was about thirty degrees across, so at 10,000 feet, it was doing about 2,000 m.p.h. At arm's length, it was about 1" long, and about 3/4" wide, so that means it was about 400' long and 250' wide. Its thickness, based on a proportional estimate, was around 50'. The ship was virtually a five-story building, having the size and shape of the space at a football field with the track around it. It was lenticular in shape, like a lozenge, with rounded edges. The following is a copy of a painting I did of the ship:

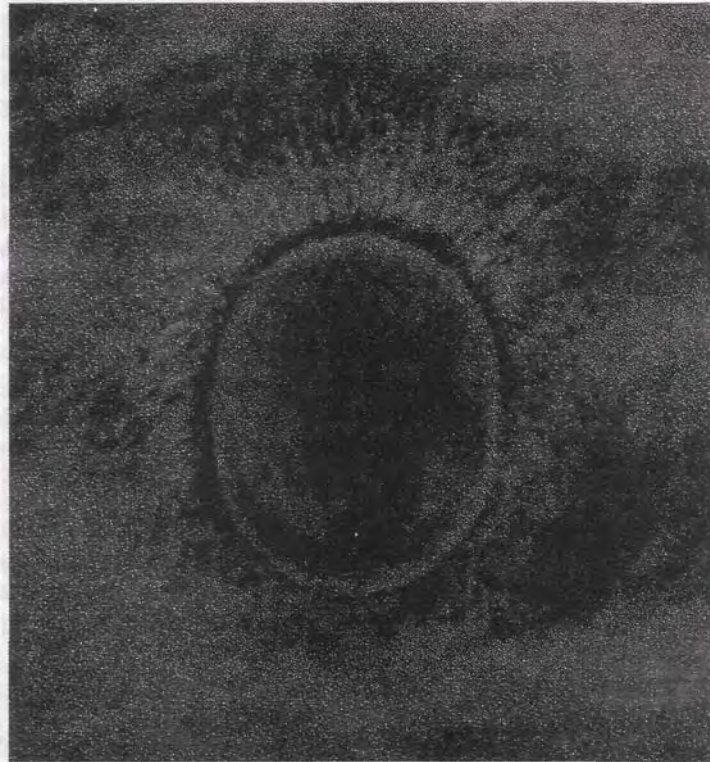

There was a "dark space" around its immediate periphery, beyond which there was a purplish "Tesla corona", which extended out for some distance in advance of the ship, and fanned out along the sides as it moved through space. A ship of that size would be large enough to carry a whole battalion.

When the word reached Richard Sauter¹⁹, another writer, that I'd seen the ship, he called me up from Flagstaff, Arizona, and asked, "Bill, what's this I hear about the 'alien grays' and their underground base under Santa Fe Baldy?" My answer was, "Richard, don't give me this shit. I see you've sold out to the alien liars."

In 1961, some friends of mine, oil operator George P. Parker and his wife Margery, of Midland, Texas, and her brother Gordon (an F.A.A. official) and his wife, told me about the time they decided to 'innocently' walk into a box canyon ("Manzano-Coyote Canyon"), called "Manzano Base", near Kirtland A.F.B., in Albuquerque, back in the early '50s. Their plan was to pose as casual hikers, so they could check out rumors of a government flying saucer base there. Like another friend, the late Bob Guthrie of Santa Fe later experienced, they were surrounded by troops carrying star wars weapons, as a row of flying saucers hovered over them. In dire fear of their lives, they were ordered out, and instructed never to say anything about what they saw. The following facsimile clipping relates to 1980 sightings at Manzano Base (emphasis mine):

U.S. reports UFO sightings

<p>ALBUQUERQUE (AP) - Recently released government reports tell of five sightings of unidentified flying objects near Kirtland Air Force Base in 1980.</p> <p>But Air Force scientific adviser Jerry Miller says in the report that "no conclusions could be made whether these objects pose a threat to Manzano-Coyote Canyon areas."</p> <p>Nearly all of the reports are of UFOs spotted in the vicinity of Kirtland Air Force Base and the nearby Manzano Weapons Storage Area. Coyote Canyon is a test area for the military.</p> <p>Miller was an investigator for Project Blue Book, the Air Force's massive investigation of UFOs that ended in 1969.</p> <p>Col. John Aday, chief of public affairs at Kirtland, said Project</p>	<p>Bluebook concluded that UFOs are no threat to the national defense.</p> <p>Aday said he had "no idea" what the 1980 sightings could have been.</p> <p>"I could conjecture all day about what might have been going on out there, but I won't," he said.</p> <p>The reports were kept secret until they were released in December through the Freedom of Information Act to the Mutual UFO Network, a Texas-based UFO study group. The reports describe the following sightings:</p> <ul style="list-style-type: none">● On Aug. 8, "three security policemen...on duty inside the Manzano Weapons Storage Area sighted an unidentified light in the air that traveled north to south over the Coyote Canyon area of the Department of	<p>Defense Restricted Test." The guards saw it "take off and leave proceeding straight up at a high speed and disappear."</p> <ul style="list-style-type: none">● The next day, Aug. 9, a security guard at Sandia Laboratories observed a bright light near the ground in Coyote Canyon, the report said. He tried to radio for help, but his radio would not work.● On Aug. 10, a state policeman saw a flying object land in the Manzano Mountains between Belen and Albuquerque. The report said that when he reported the sighting to Kirtland, he was told the Air Force did not investigate sightings unless they occurred on an air base.
---	---	---

The above clipping shows that Jerry Miller, a former Project Blue Book investigator until that program ended in 1969, was later re-employed in the 1980s as an Air Force "scientific adviser" (Air Force O.S.I.) at Kirtland, in attempt to dispel clear and convincing reports of government flying saucer work being done 'near' there. Of course Miller the O.S.I. man, copped out, saying he never investigated sightings unless

¹⁹Richard Sauter, "Ph.D.", *Underground Bases and Tunnels* [1995].

they occurred on an air base! Manzano Base—which they also call "Manzano-Coyote Test (Base)"—had been a "star wars" super weapons base since the '50s, so was not specifically an 'air base' per se, and therefore 'out of his investigative jurisdiction.' "Catcha-22"!

It becomes clearer as to how these double-talk specialists are moved around by the government from one place to another, to sell the public the same kind of evasiveness, and how the evasiveness of Air Force "scientific advisers" (O.S.I. agents) are periodically enmeshed with the likes of Philip Klass and his C.S.I.C.O.P. and pseudo-skeptic ilk. It is Klass's CIA O.S.I. (Office of Scientific Intelligence) job, to pick up where Jerry Miller, of Air Force O.S.I., left off, to 'interpret' (i.e., "debunk") the legitimate sightings of the public, as well as those of guards, air force personnel, state policemen, airline pilots, and certified civilian aeronautical experts, as the result of "over-active imaginations" and "paranormal beliefs". If there is an active imagination at work here, I think it is the imagination of Klass and his ilk, in inventing new false arguments and BIG LIES to counteract the evidence of the personal experiences and 20-20 sightings of seasoned airline pilots and radar operators.

Most of the Platonist mysticism attacked by Klass and his pseudo-Aristotelians, is induced or spread by corresponding Platonist government-funded counterparts, the paranormal front groups, which descend from the Cayce group originally set up at Wright-Patterson A.F.B., Ohio, in the early '40s, including Project Bluebook, to conceal saucer secrets and promote the BIG LIES, based on the original "parapsychology" of Hitler's guru and 'spiritual adviser', Hans Horbiger, the "father of parapsychology".

Georgi Ivanovich Gurdjieff—often confused with Grigori Gurdjieff, even by his own followers—was a deranged, mystical Turkish/Russian occultist²⁰, who was initiated by Sufi masters, before branching off to form his own twisted philosophy. Gurdjieff produced much suffering in the end, via his 'students', Dietrich Eckhardt and General Karl Haushoffer (Hitler's groomers), who were Gurdjieff's students, along with a host of other monsters. We know a woodsman by his chips, and Gurdjieff's 'chips' were all too often some of the world's most heinous monsters.

The modern Russian anti-Semitic movement seemed to germinate in this mysticism, along with totalitarianism. Decayed mystical philosophies are fertile soil for the growth of other unhealthy mystical philosophies. Almost all the top fascist and communist leaders of the 20th century were students of Gurdjieff, including Mao Tsedong, Stalin, and Ernst Roehm, the homosexual head of Hitler's S.A., who carried out the 'Knight of the Long Knives', the long march of "Kristallnacht".

The Baltic-born Platonist, Alfred Rosenberg, adapted Plato's hierarchy to Nazi society, emulating those in Plato's Republic, the Iron, Bronze, Silver and Gold, with the SS being the Golden "philosopher-rulers" at the top. This hieratic order was in turn derived from Chaldean-based Hermetic and Egyptian esoteric teachings, extracted by Plato from Egyptian and Assyrian sources a few years before Alexander's conquests. The duality so typical of the Nazis and the Trilateral Commission, is based on the myth in which Hermes and Aphrodite loved each other so much that they became one person, an Hermaphrodite. This relates to the Nazi troop management manual written by Ernst Roehm, the homosexual "father of the brownshirts" , who advocated a military "group identity" principal, erroneously alleged to be derived from Spartacism, including the idea

²⁰Michael Howard, *The Occult Conspiracy*, Destiny Books, Rochester Vermont [1989].

that Spartan soldiers laid down on the battlefield and made love before battle, so they 'would fight harder for their lovers'. Roehm was executed by Hitler for turning the S.A. into a homosexual Nazi/Sparticist drag circus. Roehm's manual, based on Gurdjieff's "Synergy", was adopted by the U.S. Congress soon after WW II, as the official troop management manual for all U.S. military forces, which I believe has subsequently eroded individuality, causing progressively poorer performance of American armed forces. There is always confusion and misperception as to what "excellent" military performance is. Those who are impressed with the parades of spit-and-polish, goose-stepping jack-booted thugs in beautiful uniforms, marching in perfect precision, such as those in Leni Riefenstahl's *Triumph of the Will*—a propaganda film commissioned by Hitler—are bound to make the mistakes of history. Who won the war on the field of battle? Was it those who marched so prissy? No! It was American guerilla fighters who continued to fight when 'order' had broken down, at the Battle of the Bulge. The "Redcoats" at Lexington were mostly Hessians who marched and looked rather smart in their beautiful rank and file, but the Minutemen shot them like fish in a barrel. How could they miss?

Before WW II, Hermann Goering was an "ecologist"—the Waldmeister—keeper of the Bavarian forests. In ecology, one specie is sometimes sacrificed for the benefit of another, in order to achieve a (teleological) "balance of nature". A forest is often "thinned out", because its population may be "too great". By construction, one can move the concept of ecology around to the human race, so they can be "thinned out" like "weeds". My point is that the kind of people who want to control the population—often attempt to convince us they are only interested in 'ecology', also making (insincere) overtures to entice our curiosities about decadent old secret mystery societies, maybe even appealing to ethnic, religious, racial or tribal sympathies—and are the kind of people who will tell you whatever it takes to motivate you at your own level, to support their plans, which may include the extermination of you as an "undesirable" or "expendable person", like a "human weed". I am appealing to your rational self-interest, since it is irrational to sponsor the extermination or enslavement of others, just because you are led to believe you will benefit from it, because sooner or later, in a criminal society, the business end of the gun moves around to you. The individual human life is the ultimate value because you are human.

The kind of people who want to talk you out of the validity of your senses, as tools of cognition, and to convince you that your life is just an illusion, while saying "all things are possible", are trying to trade you a bill of goods for your Bill of Rights. These same people do not want to improve the clarity of your thinking, or to root out and expose the high and mighty power rats who control our government. You will never hear them trying to take power away from the Trilateral Commission-C.F.R. bunch. They only want to throw a monkey wrench into the cogs of your mind, so you will never figure them out, and will do as you are told.

Refusing to believe what one sees is Platonistic and mystical, not Aristotelian and rational. Believing what you see, what you have good reason to believe is true, and what you have good reason to believe others have seen or know, is the rational, scientific approach. It is also reasonable to be suspicious of government truth-saboteurs who mix phony, pseudo-Aristotelian epistemology with Platonist bullshit. It is also rational to disbelieve the sleazy people who will lie for T.V. programs, claiming they were

"abducted by aliens". A future plot's "germination" was revealed by a clipping of March 11, 1993, by Cox News Service.

A synopsis of the clipping is as follows: In rural Alabama, a 'documentary' film maker became a "police officer", while another "UFO professional" (Linda Moulton Howe) interjected her "expert" (O.S.I.) twisted opinion that "aliens" are responsible for "bloodless cattle mutilations" in Alabama, near Sand Mountain. Howe's officious covert CIA intermeddling was necessary to fabricate groundwork for her next government-backed film. In the Alabama back-woods locale, there was little of the type of official denials which relied on the "documentation" of ex-F.B.I. agent/federal grant huxter Ken Rommel (which attributed mutilations to 'predators'), with more credence being given to New Mexico State Police mutilations investigator Gabe Valdez' "secret government medical experiments" theory ("..Another theory: Government agents, flying in low-level helicopters at night, are killing animals and removing their organs to study the effects [testing for cancer and other diseases] on livestock living near high-power lines.").

Meanwhile, local skeptic and good ol' boy John Strawn of Albertville saw through the corn, but threw out the baby with the bath water, intimidated by the C.S.I.C.O.P. false accusation that seeing "flying saucers" equated with seeing "little green men". He mentioned a "swamp ape" rumor (Hapi?), probably spread by Nazi/CIA Egyptologists out of the N.A.S.A./O.S.I. center in nearby Huntsville—the "Peenemunde of America"—created by the Illuminist, Wernher von Braun. Again, through a fraudulent mixture of Platonist and Aristotelian epistemology under the "government agent theory" of cattle mutilations, "saucers" were disassociated from "mutilations", and "copters" were switched for saucers, in these sightings by a gullible, back-woodsy 'audience' in rural Alabama. My applause goes to the Cox News Service for a comparatively fair and objective article.

A 1993 example of false propaganda—an AP article in the Albuquerque Journal, of March 12, 1993—regarding Manzano Base (A.K.A. "Coyote Canyon", referred to earlier), stated that the government now calls the "...hollowed out mountain bunker complex" (the '50s 'star wars' flying saucer base in the Manzano mountain box canyon "an old weapons storage site" and "archive of top-secret parts from old nuclear weapons". The article further stated that only "last year", "nuclear weapons" were moved from there to a "new underground storage bunker" at Kirtland A.F.B.

Just before the purported "move" to Kirtland, it came to the attention of federal officers that New Mexico Land Grant heirs own the property in Coyote Canyon, and that the government never acquired title (an 'omission' previously ignored by defense department property procurement agents). Since even N.S.A. rules cannot authorize the U.S. government to claim title, except by proper purchase and deed from the grant heirs, the government's use violates the (international) 1848 Treaty of Guadalupe Hidalgo, and is in contempt of Congress, for a fraudulent breach of their trusteeship duties.

So—if the article is even partly credible—the Defense Department high-tailed it to Kirtland with its saucer/star wars paraphernalia, leaving the D.O.E. holding the bag, since the grant heirs now had a legal right to immediate possession of the base, as well as to recover damages for the wrongful ouster, illegal detainer, uncompensated use, and radioactive contamination.

ABDUCTIONS: TRAVIS WALTON VS. VICKI LANDRUM

On Nov. 5, 1975, Travis Walton, a young federal employee of the U.S. Forest Service in Arizona, and his fellow crew members, were leaving work just after dark, driving a pickup slowly toward Heber, over a rocky road through the isolated timberland of Sitgreaves National Forest, northeast of Phoenix. When they encountered a glowing, ovalesque, government flying saucer hovering within 20 feet of the ground, around 8 x 20 feet in size, they stopped the truck, and Walton walked directly toward the saucer, despite the fact that it had its warning beeper on. As Walton approached dangerously near to the saucer, the turbine whined, the saucer precessed, and Walton was struck by an electric arc which passed through him to the ground. Walton was knocked down and struck his head on rocks, causing a concussion, rendering him unconscious. This bolt of high-voltage, high frequency A.C. current, was the 'ether-blocking' current which Tesla used on the bottom of his saucers when hovering. Lucky for the drunk Walton that it was a Tesla current, the high frequency 'skin effect' of which did not really harm him, but must have startled him so much that he lost his balance, fell down, and hit his head.

As Walton laid there unconscious, his fellow crew members panicked and fled in the truck in blind fear. On realizing that Walton had been abandoned in an unconscious and injured state, the saucer crew picked him up and took him to a secret flying saucer flight training base infirmary. Government doctors kept Walton in an unconscious state, probably with chloral hydrate (a soporific), allowing him to regain temporary consciousness only for purposes of an "alien abduction hoax" they enacted, thus attempting to prepare him for later use as a 'witness'. Midgets—or what could have been children or small women—dressed in our standard 'alien' get-ups, stood about him as he awakened. Walton later initially reported hearing one of them speaking in a southern drawl, until they realized Walton was conscious and stopped speaking. Walton wandered about in a dazed state for a while, visiting a saucer flight simulator which was equipped with an astronomical projector, and saw three saucer types—ovalesque, rounded, and sauceresque—all "without angles" and constructed of polished metal. His description of the simulator's visibility and navigation system is consistent with the use of geodetic I.G.S. transponders for navigation, and electronic image converter tubes (I.R.), mounted in the saucer's surface, to project images of the outer landscape and cosmos onto a globular screen surrounding the pilot's seat.

Walton was then subdued and re-sedated by mute, normal-sized people (both men and women), disguised as "aliens" with identical long, dirty blond wigs, makeup, and clothes. Walton's description of the midget participants was consistent with the 'foam rubber masks' and 'sunglass-lens eyes' scenario, intended to hark back to the "Roswell" hoax.

This story bears certain similarities to that of Vicki Landrum, except for the phony aliens about which Walton now lies, and the fact that all the Walton incident witnesses were federal employees. Had Landrum gone along with the program, she and Betty Cash might be rolling in cash from 'their movie'. Nothing has been said recently about the "space alien with a southern drawl", since Walton's initial report. Perhaps that 'alien' was recruited in the Huntsville, Alabama area, by Wernher von Braun, unless they talk "southern" in outer space. You might be a redneck if you use your flying saucer for a chicken coop, and take your barbecue sauce with you on 'mutilations' missions.

Had Vicki Landrum and Betty Cash been more 'cooperative', we would undoubtedly be reading about their "abductions" or seeing them on the X-files, or Sightings. Their incident has become one nagging and persistent ache in the Big Lie program, ever since this book came out in 1993. Prior to that, The UFO Encyclopedia²¹ at least admitted that Betty Cash had developed breast cancer, and that Vicki reported seeing a "diamond-shaped" ship, but added that it must have been an "...unshielded nuclear reactor" (since Betty, Vicki and Colby Lee all had apparent and indisputable radiations burns). A levitating, unshielded nuclear reactor? Sure sounds like a government flying saucer to me.

As stated previously in the Introduction, the process of concealment involves obliteration of the "Most Rational Alternative" to the two sets of Big Lies—those of the Klass Psychophants and those of the (George) Adamski Psychophants—so that the generally conservative public buys the first set, the lunatic fringe buys the second one, and the two mutually complimentary sets of lies fit tightly together to exclude reason. The "alien" and "paranormal" issues are so firmly attached to the "belief in saucers", that those who see saucers automatically believe they are seeing "space aliens". With this false idea firmly implanted in their minds, their hearts usually pound so hard in their throats and brains, that their perception is altered, as their imaginations conjure up pictures of pilots with large ("sunglass lens") eyes, large heads, and small noses and mouths, because they have been brainwashed for over 50 years. All they really see is a damned flying machine, flown by human beings, but the cunning interjection of the incredible possibility that aliens are involved, drives the 'quasi-realistic' people into the Klass position (that saucers don't exist), leaving the Adamski mystical masochists behind with the O.S.I. con-artists, as 'partners in martyrdom', while ridicule is heaped upon all witnesses, whether the false ones (the agents posing as irrational dupes), or rational and sane analysts such as myself.

Some government agents posture themselves in an 'anti-government' stance—to convince us they are legitimate seekers of the truth—to put the idea clear out of our minds that they might be government agents, telling whatever stories necessary to motivate dupes at their own levels. Doesn't it give you a nice warm feeling when you hear someone seeming to reflect your every belief...someone you can trust? This is supposed to make you believe whatever they say. Whenever you hear someone like that, question their motives, as they try to exploit you through your's. There is usually some contradiction between their conduct and their vested interests. For example, if Philip Klass really applied the stringent "test" which he says he does, requiring "physical evidence" for proof of the existence aliens OR flying saucers, then he wouldn't believe in God, because he doesn't have physical evidence to prove God exists either. I have physical evidence proving the existence of flying saucers in the form of my Peiltochterkompass. Vicki Landrum and company had physical evidence in the form of their burns and symptoms of radiation sickness, corroborated by the government's admissions.

The argument that the Klass ilk will never make, is that flying saucers are exclusively man-made electro-propulsive ships, and that the alien scenario is an orchestrated Secret Government fraud.

²¹John Spencer, The U.F.O. Encyclopedia, Avon Books, N.Y. [1991].

To finally clarify the design and methodology for the Secret Government mind-control conspiracy, I will identify and analyze a sort of eddy current effect, manifested by a syndicated newspaper column called Down to a Science, written by Keay Davidson of San Francisco, written from the perspective of the Klass Psychophants, from the Apr. 7, 1993 New Mexican, concerning the movie, Fire in the Sky, and another movie, Oliver Stone's J.F.K. The article is a small one, which fulfills an important function in a BIG LIE hoax (BIG LIE RULE NO. 2: TELL IT OFTEN ENOUGH). The clipping follows:.

N. Mex.
4/7/93

DOWN TO A SCIENCE

SKEPTICS CORNER: The new movie *Fire in the Sky* is doing bang-up business at the box office. But viewers should beware, our good friend Andy Fraknoi warns in a recent mis-sive. One of the nation's best-known popularizers of astronomy, and a longtime leader of the Astronomical Society of the Pacific, Andy says the film's so-called true story of UFO abduction is, in fact, based on a "clear hoax." He reminds us of facts that have long been known to UFO debunkers — facts that have been downplayed by the film's promoters at Paramount.



For example: The film's protagonist — Arizona lumberjack Travis Walton — claimed UFO-nauts kidnapped him on Nov. 5, 1975. That was only two weeks after NBC had premiered what was (at the time) the most famous movie about an alleged UFO abduction, *The UFO Incident*, starring James Earl Jones. Curious timing, no?

It gets stranger when you consider that during Walton's absence, his mother and brother seemed unconcerned. They told local law-enforcement authorities that Travis had been interested in UFOs prior to his "kidnapping." Also, he had urged them not to worry if he was ever abducted by saucer beings, because (he predicted) he would return safely! And Walton's credibility was questionable: Several years earlier, he and an accomplice had pleaded guilty to burglary and forgery. They got two years' probation.

For more details, go to your public library and read any of Philip Klass's many books. This veteran aerospace writer is the nation's ablest and wittiest UFO debunker, and he poked as many holes in Walton's fable as there are holes in Swiss cheese. And for a broader view of Hollywood's willingness to make money by twisting history, read Edward Jay Epstein's devastating critique of Oliver Stone's film *JFK* in the March issue of *The Atlantic*.

—Keay Davidson

The article is what will call a "triple-lie-repeater", and is a good example from the daily press of how the Secret Government persistently derails the most rational assumptions and manipulates the public, relying upon gossipy news writer dupes to spread repetitious propaganda designed to create bewilderment and confusion, and to orchestrate the staged fight between the Klass Psychophants and the Adamsky Psychophants, as co-conspirators who work together under O.S.I. direction, to dominate the forum, and to exclude reason.

Davidson co-authored a highly Big-Brother-Liar-touted book on the Really Big Bang²², just chock full of the kind of powerful pseudo-science that one expects from the main author, who just happens to be employed at the Lawrence-Livermore Lab. Davidson is also involved with Klass, The Skeptical Inquirer magazine, and C.S.I.C.O.P. Taking Davidson on his face, he is incapable of discerning subtleties, and is a dupe of the pseudo-rational, polarized thinking of the Klass ilk, though I find it hard to believe that a 'scientist' could be so naive, or worse, stupid

None of this incessant propaganda deserves to be dignified by a direct response, or slightest iota of credibility. I am using specific types of hoaxes as examples of the design format and method for their implementation. Each of these hoaxes (such as Ken Rommel's New Mexico cattle mutilations pseudo-study), becomes "documentation" for other hoaxes, ad infinitum, thus eventually building up a massive 'preponderance' of phony "evidence" to back up one or the other of the two sides of the phony fight. When the fight dies down, they do something to stir it back up. The hoaxes contain mixtures of fact and fiction. The fiction is used to misrepresent the facts, while the facts are misrepresented as fictions, so that the Secret Government always "wins" in the minds of pseudo-rational people.

The two hoax counterparts are complimentary. The frantically defensive, paranoid and mystical posture of the alien-abductions huxters is designed to attract the Adamsky Psychophants and invite the ridicule of the Klass Psychophants, whose posture is designed to attract sadistic bullies and residual pseudo-skeptics, who taunt and incite the paranoia of the nuts even more. The overall effect is to alienate reasonable people from the debate, or to obliterate any appeal to sanity. The pseudo-skeptic dupes pretend to represent sanity, by 'blindly denying what any damned fool can plainly see'.

The Fire in the Sky story is a double hoax—a "hoax within a hoax"—like the Roswell hoax. The "alien" huxters and their news writers, on one side of the hoax, 'versus' the protagonists of the pseudo-rational Klass class, and their news writers—such as Key Davidson, in this article—on the other side of the hoax, are counterparts to the same hoax. Whether witting liars or gullible dupes, everyone is used to create two deep ruts adjacent to one another, with no room between for rationality or truth. Both the initially bungled Roswell and Fire hoaxes were much later revised, one as the "MJ-12" hoax, and the other as the "Fire in the Sky" hoax. Originally, after Walton was rescued by the flying saucer crew, the government decided to turn the emergency into a hoax—pursuant to a policy already in effect—during which Walton got out of hand, saw more than he was supposed to see, and revealed most of it in his initial 1975 press, radio and magazine interviews. This caused more harm than good to the intended hoax, so it backfired. This explains the 17-year silence before the "Fire in the Sky" patch-up job (they figured, how many people would have files so old?), similar to the 38-year lapse between the Roswell hoax and the MJ-12 hoax.

The second (Fire) hoax involved Walton's witting participation—enticed by a movie—ignoring his earlier interviews, and used new lies designed to cover up critical facts inadvertently made known to and revealed by Walton in 1975, concerning his free-lance excursion from the infirmary and through the training base facility, including the flight simulator and hanger areas, while in a semi-violent and drugged-up stupor.

²²George Smoot and Key Davidson, *Wrinkles in Time* [1993].

These ostensible facts were entirely omitted from the movie, and were replaced by BIG LIES, relying upon the probability that there are just so many pudding-heads out there willing and anxious to believe them.

The mass audiences of movies and T. V. are relied upon to stamp out rationality. Davidson's sole basis for alleging fraud by Walton, was the fact that NBC's The UFO Incident (the Betty and Barney Hill fabrication) was premiered only two weeks prior to the Walton incident (another government fraud), which only proved that the government was already aggressively implementing the abductions format, as borne out by Travis Walton's experiences. Only this could explain why the government hucksters already had their "costumes" and "script" ready to go at the time of the Travis Walton incident. Despite the lies, the facts show:

1. That Walton was injured in 1975, by electrical discharges from a saucer (similar to Vicki Landrum, Colby Lee Landrum, and Betty Cash in 1982), causing his fall and concussion; and,

2. that the injured Walton was rescued and given emergency medical treatment at the secret saucer base infirmary; and,

3. that during this treatment, Walton was exposed to an "alien play" enacted by government personnel, in a corny hoax intended to prepare him for later use as a "witness"; and,

4. that due to the leakage of critical facts, the government eventually paid Walton to lie pursuant to still another hoax, intended to obliterate the original facts of the 17-year-old bungled hoax, and to homogenize the hoax with the newly implemented "abductions" format.

Since there are now many more saucers in use than ever before, more incidents are inevitable. The need for more 'streamlined' hoaxes has resulted in a new wave of government-funded hoaxes. The abductions hoaxes have emerged as the most convenient, since the new age movement has provided an almost endless supply of hypocritical 'spiritualists', willing to lie and fantasize their sexual indiscretions, hallucinations, and nightmares, etc., into "abduction experiences", at \$50,000 a whack. A whole new generation of designer drugs are available to neuter, convince or convert people who might otherwise have been lobotomized or killed a few years ago. A few of these 'manufactured' witnesses are actors, a few are paid professional liars, a few are drug-induced guinea pigs, and many more are the inevitable dupes. Skilled CIA psychiatrists are available to guide the dramatis personae through their proper performances, as they become Secret Government "movie stars".

In a letter to Walter Bowart from Julianne McKinney²³, backing up what I said in my first edition, McKinney stated that she had interviewed 125 government mind control victims. One was used in the "Alien" program. Now in her 40s, she was used as a young child because she was "...small and just the right size for wearing the costume of a

²³Letter to Walter Bowart from Julianne McKinney, Director of The Electronic Surveillance Project of The Association of National Security Alumni, Silver Springs, Md., June .16, 1994.

'gray', the big-headed aliens with big eyes and a skinny neck which many UFO 'abductees' sketch under hypnosis." She said the head and neck were manipulated by means of electronic gadgetry built into the costume. Here was a case where the Secret Government's "special effects" antedated Hollywood's by 10 to 15 years.

According to McKinney's expert documentation, the Government's special effects have at least caught up with Hollywood's, since the amateurish first attempts made during the Roswell Rhesus Monkey Hoax, and she further stated: "Having been given no reason to believe otherwise, I have personally concluded that so-called UFO abductions, and the events surrounding those abductions and sightings, are a "black" intelligence operation, involving government-sponsored kidnappings, experimental drugs, surgical experimentation, sophisticated electronics and directed-energy technologies, implantable micro circuited devices, experimental aircraft, Hollywood-style special effects, and the exploitation of so-called 'abductees' as sources of ova, sperm and aborted fetuses for use in government-sponsored genetics experiments".

Then, on the issue of "Hollywood", I am certain that the Secret Government controls a lot of the movie business. In late 1974, I was offered a choice of two parts in an Italian movie being shot at Cinecittà in Rome, about the downfall of the Allende government in Chile, and the part played by the CIA in its overthrow. The movie was supposedly produced by the P.C.I. (Partito Comunista Italiano) and directed by 'Communist' director Giuseppe Ferrarri. The movie was covertly produced by the CIA, which was behind securing the part for me. The other part went to American actor, John Kellogg. I walked away and did not do the part, since my complicity would have indebted me to the CIA. What better way to control the opposition, than to lead it?

99.9% of the audience have never dreamed there could be government backing for such movies as *Fire in the Sky*, something Davidson could admit only if he were not a witting agent. As a Klass psychophant, he not only pseudo-debunked the movie, but used the occasion to lay the blame for the OSI-created hoax—along with the news media's laziness, stupidity, and prostitution (using as an example Oliver Stone's excellent movie *J.F.K.*)—on "Hollywood". While many of the news media and Hollywood are undeniably on the take from the Secret Government, Jim Garrison and Oliver Stone—neither of whom sold out to anyone—weathered horrible harassment, and survived to valiantly debunk the Secret Government's hoax concerning the murder of J.F.K., which reflected heavily on the manipulation of party-liners like Davidson, the usual fascist liars who created obstacles to getting to the bottom of Kennedy's death.

Some news writers seek to endear themselves to the Secret Government, attacking the good, the brave, and the true, from among the safe ranks of the evil, the cowardly, and the false, who parrot the Secret Government's favorite lies. Keay Davidson's "scoop" was already stale "canned corn" from the Secret Government's officially approved menu. Where is "scepticism", the spirit of courageous investigative journalism? I learned as a boy, that cowards will side with bullies, for fear of being beaten up by them. Left unchecked, bullies can eventually control a majority through fear alone. The *New Mexican* is controlled by Robert M. McKinney, from his home in Virginia, uncomfortably close to CIA headquarters. Bully for them! Their fear sustains them.

Insidiously, a major mind-control propaganda center—serving up more Secret Government canned corn—operates out of Sedona, Arizona, particularly through

publishers with names similar to "Light Technology Publishing". The ulterior purpose is to conceal the man-made nature of flying saucers and continue the Illuminati mind-control of We the People. Names such as "Holy Light"—with facetious allusions to Illuminism—appeal to dark mysticism, as a typical diametric reversal, by substitution of "dark" ("ignorance") for "light" ("knowledge"). This mass-psychology propaganda preys upon ignorance, superstition, psychosis, and neurosis, and gathers, encourages, and organizes mass paranoia and delusions. Activity is focused on exploitation of the "new age culture", the "collective unconscious" theories of Swiss psychologist C.G. Jung, and some pseudo-Native American 'spiritual' stuff, all thrown into a mystical slumgullion stew of new age groupies and Secret Government liars. This is insulting to Native Americans, seeking to prey upon and use them as cheap 'ornaments' to decorate the bizarre carnival ballyhoo, because Indians are "in", as the Illuminati cashes in on current new age fads, even enlisting some Indians' witting participations. This conjures up some words uttered by the "devil" (read "the Secret Government") in Goethe's Faust:

"Contempt your capacity to think,
Which is Man's greatest power;
Welcome Misty things and sorcery
And the spirit of Illusion,
Then I shall get you surely enough"

There is an obvious predominance of some of the tackiest people on this planet, who, like lumps of dough, have been molded into cookie-cutter images designed by panels of CIA Ph.D.s. This seediness is a mirror-image of the sociopathy of misanthropic Illuminati mind-engineers, based on their underestimation of the 'American character', and that of human beings in general. For such work, 'inductees' must have a lack of individual worth and self esteem—like ideal bureaucrats—as the defective genotypes to be used for transmutation into tacky, pathetic, new age stars, designed and used by the government. Thus insecure, weak people surrender to a phony lifestyle, in exchange for money and (self-delusional) worth, where before there was little. Fringe benefits for the new age 'celebrities', include enhanced sexual, romantic, and socio-economic opportunities, similar to the tacky relationships between the likes of Jim and Tammy Bakker, and their adulating followers. These benefits are undoubtedly part of the appeal to such people, providing a much better life than they might otherwise have, in addition to giving them false patriotic pride in the delusion that they are doing it all "for their country". The CIA (the "devil") calls this "recruiting", and asks each new prospect, "What is the price of your mind?"

The choice of seedy people is obviously an appeal to the lowest common social denominator—a sort of "affirmative action for the tacky"—emphasizing "emotions", "feelings", "the heart", and "faith", etc. ad vomitus, enticing emotionally unbalanced, pathetic people, who need help in tying their own shoes. This induces already helpless people to stay right where they are, rather than strengthening their use of minds and resources in constructive ways. The end result contravenes the U.S. Constitution, Art. I. Sec. 8, which legally requires the government to "promote" (not destroy) "...the progress of science and the useful arts", by maintaining (not halting) the flow of inventions and discoveries into the public domain, for use by all.

How much irreversible damage has been done by these programs, which are somewhat successful? Are we doomed to a future of archaic technology, delayed progress, planned ignorance, and Illuminati mind-control? Do we expect our government, at some undetermined future date, to suddenly 'fess up', admitting it has been insidiously brainwashing and lying to us, to control our minds and will powers, for our "own good", at our expense, for over 50 years, without our permission? Don't hold your breath. It is time for a reckoning, and further delay will cost us billions, and untold damages of many kinds.

In the face of huge economic losses we are experiencing daily from technology-concealment, some may ask what the harm is, in the government's herding a bunch of naturally superstitious suckers into a new age religion, when they might otherwise have been under the spell of some other form of mystical or 'spiritual' scam anyway? My answer is, such matters exceed the jurisdictional limits our constitution places on our government, and this outrageous Secret Government program for the subliminal manipulation of We the People, is a religious, mind-control, psychopolitical brainwashing scheme, run by BIG BROTHER, which has at least four very damaging results, as follows:

1. It is an unconstitutional violation of our First Amendment rights, in which the government is secretly doing what it is forbidden openly do by law, namely, sponsoring an establishment of religion, abridging the principle of the separation of church and state; and,

2. it fraudulently conceals and misrepresents material facts from We the People, to our detriment and the corporate fascists' benefits; and,

3. it promotes the educational, intellectual, scientific and moral decline of We the People, by concealing knowledge, and inducing dishonesty, psychological disorientation, and detrimental reliance on ignorance, mysticism, and superstition in people who need rational guidance; and,

4. it violates the fundamental democratic right to government by consent of the governed, through secret, subliminal manipulation of We the People, who cannot consent to things being done to us by BIG BROTHER, in our own name, without our knowledge.

Those in the N.S.A. and CIA believe they can do whatever they want to and get away with it, because their activities are "secret". The secrecy protects the Illuminati from the consequences of their illegal acts. Without evidence, what can we prove? There is no legitimate authority for the CIA to extend its "covert operations", under its "Clandestine Services", into our domestic lives, producing the illegal and bizarre effects and damages which these operations show. There was never any legitimate authorization for these unconstitutional activities from the outset, when they were commenced through a fraud on the American People, when the bankers 'created' false authority for the United Nations, the NSA and the CIA at a time when the people were preoccupied with celebrating the end of WW II. Congressional approval of the "National Security Act" was entirely circumvented in secret meetings, such as that held by the Council on

Foreign Relations, on Jan. 8, 1968, at their 'home', the Harold Pratt House, Park Avenue, New York City, chaired by C. Douglas Dillon, private investment banker. These operations are approved by the Illuminati, without official status or legitimate authority, to secure their own corporate-fascist power. The fraudulent 'act' was never an "Act of Congress", since it just 'went into effect' through the coercive effects of the power of money and political influence exerted by the C.F.R.

This book gives the public the wherewithal to reverse these sickening policies, and to provide a means for obtaining unheard of freedom and prosperity, through openness, free competition, knowledge, creativity and reason, by rejection of the secrecy which is the basis for the lies, and by our acceptance of flying saucer knowledge...just the kind of things which the Pseudo-Illuminati hypocritically claim to promote.

In 1894, before the Ford Model "T" had been created by Henry Ford, Tesla had already tested his (flying saucer propulsion) theory, as confirmed by statements to the FBI in 1943, by a New York socialite named Marguerite Merrington, who witnessed "metallic plate suspensions"²⁴, in statements taken just after Tesla's death and shown on a "List of Persons Associated With Nikola Tesla". The FBI/CIA censors missed this small reference, and failed to black it out. They did, however release a misinformational and tampered photocopy of a 9/22/40 article by William L. Laurence in the New York Times entitled "Death Ray" for Planes". In that article, they stated that "only two" of the four parts had been tested, and substituted the word "repelling" for "propelling", as discussed on page 22 and 23, to coincide with misinformation in the HAARP "patent". The copy of the news article I have backs up what I say.

This cutaway drawing is a close approximation of Tesla's "Flivver Machine":

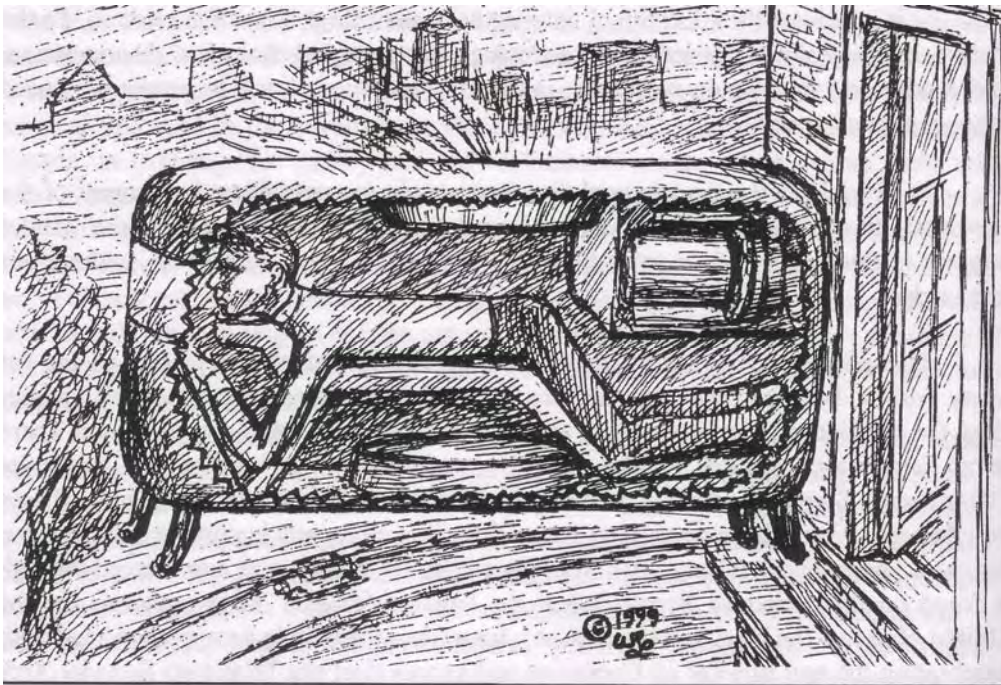

²⁴FBI Documents Regarding Nikola Tesla (252 pages released in the 1980s under the FOIA).

CHAPTER V: HOW TO BUILD A FLYING SAUCER

Author's Disclaimer

In consideration of the author's sale, and of the reader's purchase or reading of this book, the purchaser or reader is hereby deemed to understand and agree to the following:

1. That she or he assumes all physical risks of any harm to anyone, attendant to the constructing, testing, flying, or attempting to fly, a flying saucer constructed as herein suggested;

2. that the author assumes no liability whatsoever, either civil or criminal, as to these suggested plans or the theories contained herein, and is hereby released from any and all liability or claim, or allegation of liability;

3. that the purchaser or reader, who is presumed to be an ordinary, reasonable and prudent person, with control over his or her decisions and actions, is urged to respect the obvious and inherent dangers of electricity, the force of gravity, and flight, and to become familiar with pertinent F.A.A. regulations and applicable state and federal laws, if any, and hereby assumes complete responsibility for all such particulars;

4. It is hereby agreed and understood that these plans are hypothetical, provided only for the purpose of the investigation and understanding of flying saucer theory, flight and construction, and that the author gives no warranty, either express or implied, that a flying saucer constructed according to these plans will work or be safe to the operator or others.

A. GENERAL CONSIDERATIONS

First, it is recommended that a flying model be built and tested before proceeding further, as it would be very disappointing to build an elaborate saucer which doesn't work. The fundamental principle is simple: to electromagnetically synthesize momentum, employing a high voltage D.C. brush discharge, in the direction of desired acceleration, to draw in and cause the exchange of ether carriers, which also brings in the tubes of electrical force, and to cause the tubes to dissolve in the conductors of the ship, which imparts momentum to the conductors, at 90 degrees to the electric current and magnetic inductance. In order to facilitate the dissolution of the tubes of force, an alternating current of sufficiently high frequency is utilized on the opposite end of the ship, to compress and block the ether carriers and tubes of force, so that they cannot pass out the rear, and are thereby forced to dissolve to impart momentum in the opposite direction. The hull should be accelerated, creating electromagnetic momentum in the desired direction almost instantaneously.

A Tesla coil is used to create a negative D.C. brush discharge on one electrode, and another Tesla coil is used on the opposite electrode, to create an A.C. high frequency, which compresses the ether carriers and tubes of force, and blocks their passage. These two electrodes comprise a "p2"—two different primaries—one—the D.C. brush—which draws in the tubes of force, and the other—the A.C. current—which blocks the ether carriers and forces the tubes of force to dissolve. The D.C. brush produces "negative ("hairy") corona", and the high frequency A.C. produces "positive ("cloudy")

corona". It is believed that this system not only creates instant momentum in the direction of the D.C. brush, but eliminates the problem of inertia in the direction of the A.C. high frequency current, so that the rate of acceleration is virtually unlimited, and the destructive effect of acceleration is eliminated, since all parts of the ship and its contents accelerate at the same rate, without inertia. This also applies to instant turns, in which the force of acceleration acts on all parts of the ship and its contents, to re-orient the force of momentum on each atom and molecule, in the new direction, eliminating centrifugal force. The kind of ship shown by these plans however, is of what I call the "linear type", which turns in a curving path, rather than in sharp angles, because this type of ship is easier to construct and control.

In order to properly control the currents from the Tesla coils, specially designed switches, relays, capacitors, dielectrics, inductors and conductors are required. In these hypothetical plans, I provide my own design, which could conceivably be built by a skilled home craftsman. I also describe what I believe to be a control system which will be practical, reliable, and easy to construct, probably similar to what Tesla used on his "Flivver" machine, his manned, electro-propulsive ship of the earliest type.

1. SIZE AND SHAPE

Since this ship is to be of the simplest type, it is no larger than required for one or two people. It is designed to be as small as possible, yet to have the necessary equipment and space for comfort. The general shape of the craft can be described as an oblate spheroid, the shape of a moving "point charge" system. The first manned ship built by Tesla was described as the approximate size and shape of a "gas stove", which would be a sort of long, rectangular box on legs. The legs were presumably stand-off insulators so the craft could get off the ground. I assume that it was of the linear type, with Tesla crouched inside, perhaps on some sort of support, which allowed his hands to be free for the controls, with his head pointed toward a small window at one end. Electromagnets on the "front", with switching and polarity provisions to divert the brush to the right or left, would allow for complete control, with the 'buoyancy' control determining altitude. The bottom and rear would be activated by the high frequency A.C. blocking current. If Tesla wanted to turn right, he would use the electromagnets to divert the brush so that the right corner was pulled, as the air pressure would cause the ship to swing around in a circular turn. To go down, all he had to do was to diminish the current to the top brush.

Since the most efficient application of electrical energy is desired, to conserve energy and to transmit the respective propulsive force effectively, with the least expenditure of energy, it is recommended to use rounded surfaces, similar to the design of electrostatic generators, the design of corona rings, or the design used by Tesla in his Wardencllyffe Tower electrodes—rather than sharp points, shapes, or edges—which tend to cause "point discharge", the wasteful and uncoordinated leakage of electric charges into space in a manner which is unproductive.

Since the primary function is to get the ship off the ground and to remain stable while hovering, the upper surface area is generally a horizontal surface, but is spheroidally curved and somewhat symmetrical. I call the electrode from which a brush discharge is emitted at the center top of the ship, the "buoyancy electrode". This electrode is used at almost all times during flight, in addition to an electrode which may be activated at the front of the ship, to cause horizontal acceleration and to turn the ship.

Apparently, the ship will not work without the high frequency A.C. blocking and compressing current to the rear and on the bottom, otherwise, anything with a D.C. brush discharge would take off and fly away at fantastic speed. There is always an "equal and opposite" reaction. In order for there to be a "reaction", there must be a "disturbance to the equilibrium". As the ether carriers continue to exchange, bringing in the tubes of force, there is nothing to prevent them from passing out the other end of the ship, so that there would be no "reaction", and the ship would acquire no momentum. As Tesla said, the A.C. current (at the rear and bottom of the ship), when of "sufficiently high frequency", will draw ether carriers and tubes of force to itself, until they are so compressed that no further action will occur. This is apparently intended to "block" the field of gravity and to block inertia—like Dr. Cavour's 'door', painted with "Cavourite--and to force the tubes of force in the ship's forward conductors to dissolve, so that momentum is imparted to the conductors (and the ship to which they are attached), as J. J. Thomson said.

2. POWER SYSTEM

One of Tesla's patents, Method for Signaling, Patent No. 723,188, which has the two primaries marked as "p¹" and "p²"—possibly the origin of the title "p2" given to the 1935-38 New Mexico project run by von Braun—shows an oscillator system having two separate pancake-coils, tuned differently, running off a common rotary spark gap and dynamo. A copy of a drawing from that patent follows:

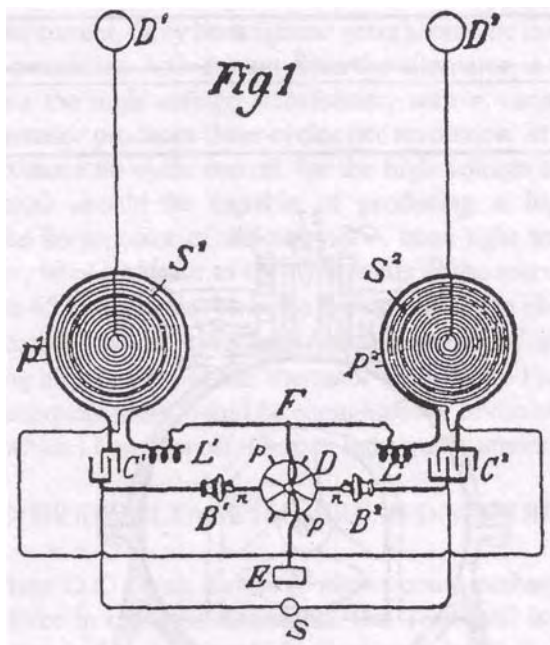

If one coil is tuned to one quarter wavelength, and the other to a full wavelength, they would comprise a D.C. brush circuit and a high frequency A.C. circuit, respectively. The A.C. circuit could be run at all times on the bottom and rear, with the brush being activated at the top to lift off, and to the front to go forward or turn.

I can't recommend a better prime mover than the Tesla turbine, because of its compactness, light weight, and efficiency. Below are excerpts from Tesla's Turbine patent #1,061,206 and related Valvular Conduit patent #1,329,559. Two conduits supply air and gas, respectively, to the firing chamber (second turbine):

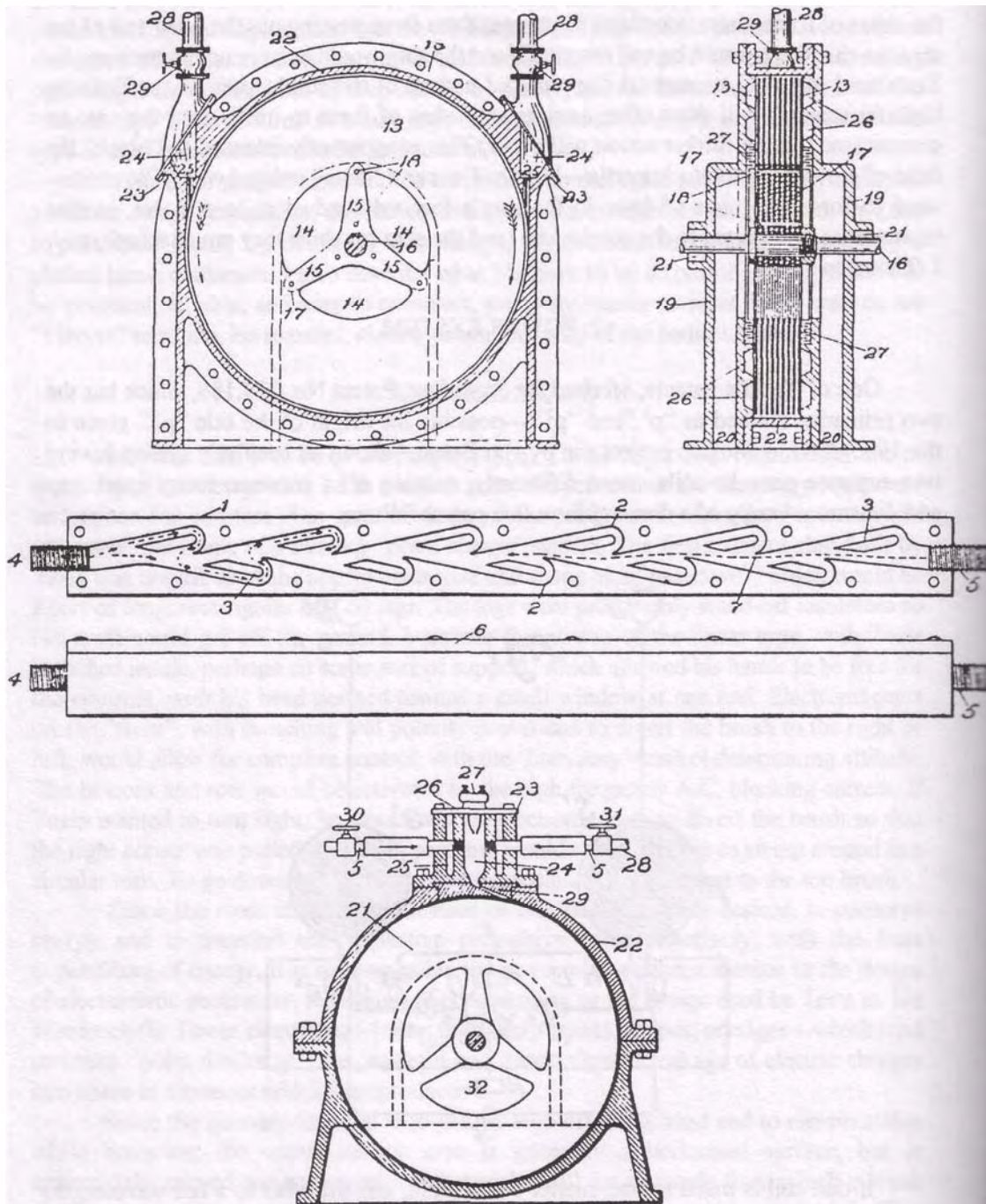

The second edition of Free Energy Surprise, when issued, will include my complete set of plans, redesigned, to be constructed using basic machine tools for the home builder.

The turbine shown will produce at least 30 break horsepower and operate at about 30,000 rpm., and should weigh no more than ten pounds, including the valvular conduits and firing chamber.

The firing chamber has a glow plug (the kind used in model airplane engines), and fires in a "reverberatory" way (the explosions come in rapid succession), producing a continuous supply of expanding hot gases, which enter the turbine on its outer edge as shown, and spiral between the disks toward the vents which are near the center shaft. I have routed the exhaust out one side of the turbine, through a single exhaust vent, rather than out both sides as Tesla did, to diminish turbulence, and to free one side of the turbine for the bearing mount and connection to the gearbox and mounting plate. The exploding gases will not blow back through the valvular conduit, which was Tesla's valve system having no moving parts, and will continue to move into the turbine inlet vent, as the combustion chamber continues to produce the pressurized gases.

Judging from the fact that the turbine will produce 30 hp on 125 lbs. steam, it should produce more horsepower on propane or gasoline, and should be adequate.

For the generator, I recommend a heavy duty high amperage automotive alternator, such as the type used on heavy equipment, or a high output, lightweight alternator designed for power generators, normally having an engine of about 30 hp.

It will be necessary to use step-down gearing to reduce the speed of the turbine, so that, at the optimum (most efficient) operating rpm of the turbine (about 25,000 rpm), it will be stepped down to the optimum operating rpm recommended for the alternator. For example, if the alternator is to run at 1,200 rpm., and the turbine at 25,000 rpm., the gearing would have to function at a 20:1 ratio. A battery will also be required to supply the appropriate exciter voltage, and to store electrical energy for appliances and other necessary on-demand current. Only herringbone gears should be used in the gearbox.

By using an unrectified A.C. current from the alternator, it should be possible to route it directly into the high voltage transformer, with a variac to regulate it. For example, if the alternator produces three cycles per revolution, at 1,200 rpm., it would produce the approximate 60 cycle current for the high voltage transformer. The high voltage transformer(s) should be capable of producing a high amperage output commensurate to the horsepower of the turbine. A neon light transformer, producing .030 amps at 15 kv., would amount to only 450 watts in the secondary, for a generator which could produce 45 kw or more. To be on the safe side, you should use transformers for each pancake module which have high voltage ratings of at least 5 kw in their secondaries (totalling almost 50% of the alternator's capacity). I can't imagine that this system would be inadequate. This would be enough power to run about 50 Tesla coils of the powerful types which I have run off the neon light transformers.

3. HIGH VOLTAGE D.C. BRUSH DISCHARGE

The high voltage D.C. brush discharge allows equal exchange of the electric and magnetic tubes of force in opposite directions. The Tesla coil is tuned to one-quarter wavelength, emitting negative pulses which are so rapid that the current continues to flow in the secondary, during current reversals in the primary. This steady D.C., "pseudo-electrostatic" brush discharge has a greater effect on the independent ether carriers, and 'rarifies' them, exerting an elastic, pulling force in the space in front of the ship. This induces the rapid exchange of the ether carriers through the front of the ship,

and draws the tubes of force into the conductor. In the D.C., secondary conductor, the tubes of force have nowhere to go, and are forced to dissolve, as new tubes of force continue to be brought in. This imparts momentum to the conductor, which must be firmly attached to the ship.

The thing which makes the tuned Tesla coil the ideal contrivance for this purpose, is the fact that the principles of high frequency inductance make it possible to create very high D.C. potentials, using a relatively small coil, which may be placed flat against the walls of the ship, powered by a compact alternator. This eliminates the need for the large and cumbersome parts of an electrostatic generator, which would produce only a fraction of the amperage of the Tesla coil, and a greatly diminished exchange of the ether carriers and influx of tubes of force. It has also been shown that a D.C. pulse produces a greater effect in Hall effect pumping than a steady D.C. current.²⁵

The negative D.C. pulse discharges will leave the inside of a closed hollow conductive vessel—such as a saucer is—and appear on its outer surface, as Michael Faraday discovered, which conveniently protects the pilot, crew and internal contents of the saucer from the effects of electrostatic charges.

4. HIGH VOLTAGE, HIGH FREQUENCY A.C. CURRENT

The high frequency current, required to block the exchange of ether carriers and passage of the tubes of force through the rear of the ship, behaves with a "skin effect", which means it travels over the surface atoms (the "skin"), rather than through the internal mass of the conductor, as well as the skin of other solid conductive bodies. This phenomenon also provides some convenient protection for crew members from the effects of this type current. Aside from the phenomenon of the skin effect of high frequency alternating current, internal circuits must be highly insulated and shielded where necessary, with care given to shielding of the pilot (and crew or passenger) from possible high voltage radiation dangers.

The pancake-type coils have a higher threshold for arcing at a given voltage than cylindrical or conical ones, which makes them best for these very high voltage applications. Care must be taken at all times, in the design of high voltage circuits, that the close proximity of conductors having high opposite potentials is avoided, and sufficiently insulated and spaced where necessary. Silicone rubber, transformer oil, Formica, and plexiglass are good insulators, and there is a dielectric paste which is excellent.

There is a tendency for the air close to the conductors to become ionized, creating pathways for the current to leak and arc through space to other conductors of opposite potential, whenever within range, roughly governed by the parameters of 20 kv/cm., at sea level pressure, adjusted downward for higher altitude and correspondingly lower pressure, which requires that the space be increased for the same difference in potential. Internal high voltage corona leakage and arcing between conductors, components or contacts, can be suppressed by use of pressurized inert gas environments, increased air or gas pressures, solid, rubber, plastic, oil, or paste insulators of high dielectric strength.

²⁵Beckman Instruments, Inc., Hall Effect Manual, Helipot Division, Fullerton, California.

5. VERTICAL ASCENT AND DESCENT

Due to the tremendous superiority of the electrical attractive force over the gravitational and aerodynamic forces, it should be possible to fly a saucer with a greatly diminished electric power system, but the saucer's control is a very sensitive matter, requiring the ability to activate the appropriate electrodes rapidly, in response to a need to change directions of movement, or to quickly correct inappropriate movements of the ship, because of its great speed and ability to "jump around" without inertial/momentive resistance.

The main buoyancy coil, mounted in an area above the cabin, provides the negative brush discharge, which, when paired with the high frequency A.C. coil, beneath the cabin floor, accelerates the ship upward, as the force is balanced to maintain the saucer at a particular vertical position. The high frequency current used on the bottom of the ship on hovering, seems to be the equivalent to Dr. Cavour's "door", which when shut, stops the gravitational effects from forcing the ship to accelerate toward the earth.

The description in 19th century physics literature, as I documented in *Occult Ether Physics* (especially the 2nd Edition), implies that a normal gravitating body moving relative to earth, within earth's electric, magnetic and gravitational fields, naturally draws the tubes of force into itself, where they are dissolved to impart momentum.

The downward movement of the saucer can be effected by allowing it to drop by the force of gravity, with power diminished, though it can be effected more rapidly by a reversal of the forces which accelerate it upward, but, to eliminate unnecessary complexity and danger, I don't recommend this for a prototype.

The discharge electrodes shown in these plans are of the "pancake-coil" type, which can be placed parallel to the interior walls of the ship, and will be the recipient of the momentum, which is imparted on the third axis, perpendicular to the flat side of the coil, at 90 degrees to the other two axes, which are the magnetic inductance and electric current axes. Placing the flat coils parallel to the outer walls will therefore orient the momentum perpendicular to the outer surface of the ship.

6. HORIZONTAL TRAVEL

Horizontal travel is effected by a pairing, along the ship's longitudinal axis, of the two electrodes, the D.C. brush at the front, and the high frequency A.C. current to the rear. It was believed at one time, by Heinrich Hertz²⁵, that two systems of varying current should exert a ponderomotive force on each other due to their variations, but Tesla proved that the "ponderomotive force" is due to the respective rarefaction and compression of the ether carriers, produced by different kinds of currents (D.C, A.C, and rapidly varying electrostatic forces)²⁶, and their effects on the ether.

²⁵Ann. d Phys. xxxi [1887], p. 421; Hertz's *Electric Waves*, translated by D.E. Jones, p. 29.

²⁶Nikola Tesla, *Lecture Before the A.I.E.E., Columbia College, New York* [May 20, 1891]; Nikola Tesla, *Lecture Before the Institution of Electrical Engineers, London* [Feb., 1892].

B. CONSTRUCTION OF THE HULL

Due to the magnitude by which the electrical attractive force is greater than the gravitational attractive force, tremendous stress is created on the hull of a saucer, which must therefore be constructed very strongly. While a spherical shape readily lends itself to such requirements, internal structuring members and walls should be designed, constructed and positioned for maximum rigidity and strength, to prevent the possible pulling apart of, or crumpling of the hull, as this would be the supreme misfortune.

Construction of entrance and exit ports and other such contrivances, should anticipate powerful stresses, since openings are generally points of weakness. It is desirable that the hull have a smooth and continuous conductive outer surface, which has little or no small diameter protuberances, and as few weak or "blank" spots in it as possible, caused by such things as windows (See "C. Simplified Drawings and Plans" below for available excellent source of technical construction literature with materials suppliers). Windows must be of strong, thick material, firmly attached.

1. POWER PLANT

Since the electrical attractive force is so much greater than the gravitational attractive force, it is logical that a relatively small engine, such as the Tesla turbine, or a snowmobile or motorcycle engine, would be adequate to power an alternator of sufficient power for this size saucer. Tesla designed his tiny turbines and remarkable high frequency alternators for this purpose, and they would be preferable. An independent air intake and exhaust system, separate from the air supply for the cabin, must be provided, with careful attention to preclude the mixture of exhaust gases with the air supply for crew and pilot. Batteries may be sufficient to supply electrical power for a saucer, with a small engine used periodically to recharge the battery system, as needed. As shown below in "Special Supplementary Notation on the WW II German Flying Saucers", construction of manned, 'hot-rod'-type saucers or spheres, perhaps only four feet in diameter, may be feasible, possibly using automotive spark coils (perhaps similar to some of the "foo fighters" seen and photographed by allied bomber gunnery crews, in the skies of WW II Germany). The atmospheric nitrogen-oxygen combustion system invented by Tesla, for the production of electrical energy from the air, is too complex to be covered here, and there is insufficient information as to just exactly how the system was constructed and used to produce useful energy.

2. SEATING AND VISIBILITY

Ultra-light, strong, fiberglass bucket seats with seat belts, are recommended. The closer the pilot's eyes to the windshield, the smaller the windows required for visibility, with care taken to electrically insulate the pilot's head from the ceiling. A spherical shape will provide better visibility than a 'discus' shape, and a wide-angle optical viewer might be provided directly downward, between a solo pilot's legs, if desired. This type of saucer involves a restricted pilot position, but since the saucer is so fast, satisfying flights, over great distances, should be of short duration. Small video cameras such as those often used on race cars or by skiers, having wide angle lenses, might be mounted in the saucer surface, with view screens around the interior of the cabin.

For a small, 'hot-rod' saucer as these plans describe, there are several inconveniences which must be tolerated in the name of practicality and economy. The more wealthy builder will naturally find a way to include as much luxury and high-tech controls, accessories and other facilities as he can afford or desire.

3. FLIGHT SUIT

The flight suit should provide electrical and heat insulation, with ultraviolet protection for the eyes. An insulated, cold-water wet suit might work well. Since a pilot will be looking out ports which are near the hull surface, the helmet should provide extra thick electrical insulation, to prevent arcing or electric shock to the head. In general, the suit should provide U.V. radiation protection, preferably by use of a special plastic already developed for this purpose. (NOTE: It was rumored early in the program, in the '50s, that only women pilots were used, since the male scrotal cavity is particularly sensitive to the electrical radiation problems of the saucers.)

Ironically, the kind of pull-over headgear, used by actors or pilots, often used to fake the appearances of "aliens", might be an ideal design for a saucer pilot's headgear, with thick layers of foam insulation in the top (representing the bulbous brain cavities often depicted on the phony aliens), and the sunglass-lens eyes covers would provide U.V. protection.

C. SIMPLIFIED DRAWINGS AND PLANS

The following drawings, including nomenclature, are presented in a simplified format. The details of each particular part or section, are left to the creative imagination, ingenuity and resourcefulness of the individual reader or experimenter, with the author presenting his own suggested design, predicated to provide the least possible obstacles in procurement of materials and actual construction. The skilled experimenter will also recognize that there are relatively simple methods for construction of a scientifically adequate, test scale model, and only a fool would embark on such a project without making such a test, with care taken to insure that the model is suspended by insulative string running through pullies, so that the power may not drain to ground. Such details of saucer construction as particular metals and other materials, fabrication and technology, are generally omitted from these plans, since a complete, detailed set of working drawings, with accompanying technical literature, could conceivably require ten times the length of this book.

As an excellent source for materials and techniques, I recommend Andrew C. Marshall's *Composite Basics*²⁸. This book even describes honeycomb metals and other metal/plastic bonding and structural materials and techniques, etc., and provides sources for a wealth of expert home-built aircraft construction materials and literature of many kinds. Aluminum, though light, may not be the best metal, because there are so many bonding problems with the metal. I am recommending stainless steel, since the electromagnetic flux used to divert the brush discharge for turning must be able to pass through the outer shell.

²⁸Andrew C. Marshall, *Composite Basics* [1994, Marshall Consulting, 720 Appaloosa Dr., Walnut Creek, Ca. 94596]

1. (Special Supplementary Notations on The WWII German Flying Saucers):

In this short summary, I will avoid suspected misinformation, or material which is unrealistically speculative.

There were purportedly several inventors working in Nazi Germany on various types of flying saucers, not all of which were electro-propulsive in concept, meant to operate on rocket, jet, turbojet, or prop-driven reactions of the aerodynamic type. All the video or literary material available to me, concerned this "aerodynamic" type, were either misinformational, or grossly ill-conceived "science" of the La La Land variety, seeming to be mostly contemporary Austrian new age 'thinking' or CIA-concocted garbage, containing only grains of truth. For example, there seems to be valid documentation concerning one example, the Habermohl "Pflugerad" ("Flying Wheel")--which was little more than a re-designed gyrocopter—which actually may have gotten off the ground, though even in the supposed 'documents', was said to be unstable and dangerous to fly. It combined a gyrocopter or helicopter rotor in a wheel shape, concentrically rotating around a ball-shaped cockpit. It experienced several crashes during tests, probably because the rotor gave it too much gyro-stability, so that it was unmaneuverable, there being no way to decouple the rotor/gyro from the airframe, during turns or changes in attitude. Some models showed a vertical stabilizer and rudder on the rear of the central non-rotating cockpit section, to turn it in the direction of flight. A rather good idea later used on "jet copters", was rocket or jet engines attached to the rotor, which eliminated the torque problem normally encountered with shaft-driven rotors.

The inertial guidance system ("Peiltochterkompass", or "polar slave compass") was built to meet the requirements of the "full electric" "Kreisel Teller", because the electrostatic "Faraday cage" effect created by its propulsion system made a normal compass worthless, and the high speeds (c. 9,000 m.p.h.), zig-zag maneuverability, precession, and poor visibility created navigational problems which required a special, non-magnetic compass. The Peiltochterkompass was coupled to a "Meisterkreiselkompass" ("master gyrocompass") mounted on gimbals, which generated its own angular momentum, and operated independent to the earth's gravity and the ship's momentum or inertia. This would be true even if the saucer externally cancelled the effects of gravity, inertia and momentum since, just as the sun transfers momentum to the earth by electrical current, the saucer power system transfers angular momentum to the gyro. Moving freely on its gimbals, the master gyrocompass pointed in the same direction all the time, no matter which way the ship turned, held into position by its angular momentum, as the motor on the slave compass was actuated when needed to turn the compass indicator dial in the direction of travel.

This book is the only known documentation concerning the "KT-p2" project, which from my analysis appeared to be the only true electro-propulsive saucer, and hence true "UFO" possessed by the Germans. In reiteration, any other kind of "saucer" is not a "saucer" at all, but only some sort of jet, rocket, or fan-driven plane, which by coincidence was only shaped like a saucer. There is nothing inherent in the "saucer" shape which makes it particularly advantageous over a conventional aircraft, and in most

cases, is a disadvantage, except in the context of electro-propulsion only, and this only if it is desired to have instant 360-degree maneuverability. The "saucer" projects carried out in Czechoslovakia were clearly disinformational, given the fact that von Braun had the electro-propulsive type as early as 1936 by my documentation. This has come as an embarrassment to those who have put so much stock in the so-called "S.S. documents from Wiener Neustadt", which came under the jurisdiction of the CIA and were therefore misinformational. It would be wise of you to observe who among the "UFOlogy" network has been first to make so much of these documents, as well as who among them have been suckered in by them. It is likely that true saucers were available at the Wiener Neustadt base of General Otto Skorzeny, but were not as described in the tampered literature. It appears that the O.S.I. prepared the disinformation, and disseminated it with the help of Skorzeny, who was one of the first to make such deals to stay out of jail. Skorzeny was also crafty enough to conceal several stashes of high tech documentation and plans, so that he could coerce either the Soviets or the Allies into giving him the protection he desired. The O.S.I. directed attention to the misinformation, through UFOlogy channels, just in time to anticipate my book. Many suckers fail to realize that all German saucer materials had already fallen under the jurisdiction of the CIA (O.S.S.), even before the armistice.

One writer/speaker has attempted to distinguish between "saucers of the secret societies", and "saucers which were secret weapons of the Third Reich". What is "secret" is secret, and the fact that the electro-propulsive saucers were used by the Third Reich in its air defenses meant that the "secret societies" scenario is only a fantasy encouraged by the CIA, while the Gestapo clearly could qualify as a "secret society". How secret can it get? My material is obviously more secret than the Wiener Neustadt stuff, and I had no help from the "Knights Templars" or anyone else, and have had to fight tooth and nail all the way to the day my first edition was finally published, and am still struggling. Most of my analysis of the saucer's propulsion system was extrapolated from my 1953 sighting, confirmed by what I have learned from my Peiltochterkompass. In the years since the publishing of my first edition, read by many engineers and scientists, some of whom are experts on German aircraft of all kinds, no one has produced any mention of a "Peiltochterkompass" or the "KT-p2 Projekt", from another German source or any other. This alone proves the German "documentation" has been tampered with, because of the conspicuous omission of this important project.

From these facts, it is my assessment that the so-called "S.S. documents" are either complete fakes, or have been seriously tampered with for misinformational purposes. For example, one type of German ship is referred to in the documents by the name "Kraut Meteor". Despite the fact that this was sometimes how the Allies referred to it on occasion, the Germans wouldn't have called it that in their own documents, which would be tantamount to Idi Amin Dada building an aircraft, and calling it the "Nigger Watermelon". I very seriously doubt that Hitler would have permitted the use of such derogatory and "decadent" American slang to name a supposed 'super aircraft' of the Third Reich. Having already been suckered in once by some of this material, I won't do it again, and I urge extreme caution in accepting and repeating this material, unless you want to be made a sucker out of.

Recently, I was contacted by a California person who sent me a copy of W.A. Harbison's book, *Inception* (Dell, 1991). He was under the impression that Harbison's book had pre-empted mine. Not so. Harbison's book not only was fiction (and very

interesting at that), but was based on the misconception that "German" flying saucers were the first ones, that they used an aerodynamic "boundary layer" air propulsion system purportedly invented by a fictitious American named John Wilson, and that the saucers we see today are headquartered out of an elaborate underground city built under the ice of Antarctica, run by the S.S. and worked by slave labor. Boundary-layer "saucers" would not be true "flying saucers", but would only be unusual "air-planes" shaped like flying saucers.

As proven by my Peiltochterkompass and my sightings and documentation, the German saucers were electro-propulsive Tesla craft (requiring an inertial navigation system, because of the high-voltage electrostatic discharges and "Faraday cage" effects), some of which had 360-degree peripheral maneuverability in 30-degree increments, just as I observed between 1947-53, in the night skies of West Texas.

The purported Schauburger ships (the only information we really have are photos of models built by Felix Schauburger), purportedly built in Czechoslovakia, were supposedly designed to use an "implosion turbine" to generate the power to drive an 'air-blower' intended to propel the ship. As such, it was little more than a (flying?) air conditioning vent, with an unusual engine, and couldn't have gotten off the ground. And even if by some miracle it could have gotten off the ground, it couldn't have gone over 300 m.p.h., with the dumpy design, much less over 1,000 m.p.h. as claimed by misinformationists, especially since there is not even reliable information that the ship was ever built. It is too easy to say "the Russians got it", and even if it had been built and had flown, it wouldn't be worth classifying, any more than the little engine-powered UFO toys, which at least were more feasible, and are known to actually fly.

There was purportedly a ship designed by Miethe said to be powered by 12 BMW engines—claimed in documents to run on helium—but said to use the "boundary layer" aerodynamics of Prandtl. Such a system, if true, automatically ruled out electro-propulsive ships. It is my belief that if any of the photos are partially real, the purported name and propulsion system were misrepresented, to throw investigators off the possibility of electro-propulsive ships. There is a photo (real or fake?) purporting to show Miethe explaining this type to Hitler on Apr. 7, 1944. It was purportedly tested in November, 1943, which would be only one month after the manufacture date of my Peiltochterkompass, which raises a probability against mere coincidence. For that reason, I believe that some of the photos—but not the usual 'technical descriptions'—of these ships, may be genuine. The drawings of the basic internal structures may also be somewhat accurate, disregarding the misinterpretations given to them. Large, round ball shapes are shown in the drawings, and three of these are shown in the large "mother ships" (what I call "flying submarines"). These ball shapes could have been liquid helium fuel tanks. A "helium power" system could run "BMW engines", as shown by the Papp engine shown in the Appendices. Twelve engines would suggest that each engine drove a separate electrical generator around the periphery of the saucer, which is consistent with the Peiltochterkompass design. The "Miethe saucer" could be from the "KT-p2 Projekt", the particulars (name, power system, etc.) having been obliterated and faked with misinformation. Though labels and nomenclatures of drawings allegedly from Wiener Neustadt appear to have been altered—especially the written documents alleged to have been with them, which contain silly language—some of the physical designs makes sense in terms of electro-propulsive ships, when "corrected" by my material. One sketch shows a manned "Flying Turtle", which is very similar to the ones I

saw in the WW II 8th A.F. film taken by a B-17 bomber crew. I saw this film while a member of the 26th Strategic Reconnaissance Wing, Operations Intelligence Division, Strategic Air Command, Lockbourne, A.F.B., Ohio, in late 1957. We viewed the film with other intelligence personnel, several of whom had participated in the actual bombing raids in which the film was shot. My O.I.C., Lt. Col. Edward R. Jirles, was involved with Operation Paperclip, as he was among the first Army C.I.C. personnel in the Rheinland. In fact, he was responsible for hunting down and bringing in the "Werewolves"—the last fanatical holdouts of the S.S.—for S.E.A.T.O. Capt. Weismann still carried 9 pieces of shrapnel in his body which he received as one of the heroes who bombed the Ploesti oil fields in Romania, and was sufficiently recuperated in time to be aboard a bomber for the "foo fighter" incidents. Contrary to misinformation, the "foo fighters" were not radio-controlled, unmanned craft, but were small electro-propulsive ships flown by pilots, probably Hitlerjugend.

German daredevils apparently flew these things around the bombers to disrupt their electrical equipment and ignition systems, and to draw their fire. Disruption of the equipment would have required no special equipment, since their dynamic electromagnetic fields and high frequency corona would have rendered the desired effect on allied aircraft, just as one shut down the electrical system on my father's car in 1957, just outside Levelland, Texas. That ship was about 200 feet long and was egg shaped, similar to the Flying Turtles and to those seen by Lonnie Zamora near Socorro, New Mexico.

Since the "Flying Turtle" was perhaps the simplest of all the German types, I present a simplified set of hypothetical drawings and plans for it. We have no complete, detailed photos or drawings of its design, other than the 8th A.F. films I saw in 1957, and a preliminary sketch from German sources, which I give partial credence to, and present for you with as good an interpretation as possible. The advantage of the Flying Turtle was its good visibility, and its cheap, compact, one-man, simple "hot rod" design, audaciously sacrificing everything to function, to tear into the skies and interfere with the horrible Allied "fire-bombings" that killed several hundred thousand civilians in the Hamburg and Dresden areas. Because of its oblong ("turtle-shell-shaped") design, the control system on these craft appeared to be simplified, with electromagnets in front to turn the ship. The blast of the air was relied on to pull the ship into line as the force was applied, to get the desired maneuverability in the simplest and most direct way. This explains perfectly how the "Foo Fighters" were able to fly in a spiralling pathway.

The truth of the air combat over Germany reveals heroic tales of young daredevils and wily old veterans, such as Adolf Galland, who not only flew with only one leg and one eye, but parachuted out of several shot-up Gustavs to return immediately to the sky to fight again, over and over, until there were no more planes to fly²⁹. Many of Germany's pilots fought hard, well, valorously, and honorably to the bitter end.

In the film I saw, in which the Flying Turtles circled the B-17s helically, along their flight paths, the gunners were unable to shoot them because they moved so fast, although they appeared to hit some of the much slower Me-163 "Komets" (c. 500 m.p.h.) which accompanied the Flying Turtles. The Komets were cheaply built "disposable ships", abandoned in the sky once their rocket fuel was expended. In one shot, a Komet pilot could be seen bailing out. By comparison of both size and speed

²⁹Heinz Knocke, I Flew For the Fuehrer.

between the Komet and a Flying Turtle (moving more than twice as fast as the Komet), it was obvious that the central body of the Turtle was larger than the Komet's, and was going at least 1,000 m.p.h., in a helical path. This maneuver would be the result of the pilots simultaneous actuation of both the "up" and "right" modes, in typical "joystick" fashion. These ships must have required a lot of dexterity, like a video game or a skate board. The speed was no surprise to me, since the saucer I saw in 1953 (about 5 years before I saw the film) was going at least that fast when it did its 90-degree turns.

Since my discovery of how Tesla controlled the brush discharge, to turn the craft, my plans show only one front electrode, with the "buoyancy" coils used to create the "up" and "down" movement. (Actually, an electro-propulsive ship could be flown with only one set of coils, by diverting the brush at the top to 'swing' the ship sideways "pendulum" fashion, but the speed would not be nearly so high.) Since the momentum is imparted to the conductor at 90 degrees to the electric current and magnetic inductance, the flat, pancake types, which can be firmly imbedded inside the ship's shell, are ideal. One would be placed inside the hemispherical nose. A type of simple joy-stick—controlling the electromagnets to the two sides of the front coil—divert the brush discharge in the desired direction, as the body of the craft is swung around by the air to the corresponding curving pathway, turning the craft right, left, or straight ahead.

Intelligence agencies have exerted tremendous effort to obliterate the facts regarding combat reports of German flying saucers, even inducing false reports of post-war German and Austrian "new-age" type researchers, by feeding them misinformation. Some of the researchers even relied on information obtained from the FBI by FOIA procedures. They just can't get it through their heads, that NO CURRENTLY CLASSIFIED INFORMATION CAN BE OBTAINED BY A CITIZEN THROUGH THE FOIA. All such information has been "screened out". Released documents which (once) contained classified references have the classified portions censored. That's what all those blacked out areas are, stupids! In addition, under the National Security Act, completely fabricated information is often released through the FBI, under the FOIA, to mislead researchers who seek to discover classified secrets. What better way to sucker in those who think that certain "documents" released by the FBI are necessarily valid?

So-called 'technical' descriptions, according to dupes or those who pretend to know, are downright stupid. For example, the "Feuerball" ("Fireball") is described as being a 'circular' or 'spherical', remote-controlled craft, from one to two meters in diameter, powered by a flat (radial) turbo-jet engine, which rotated the outer periphery around its axis, creating its "glowing" appearance from the effects of the expulsion of "over-rich" jet exhaust, as it spun around.³⁰ Even more ridiculous, it contained a Klystron tube (developed around 1939 by the Varian brothers, for Sperry Gyroscope Company, in America), which pulsed synchronously with Allied radar, making it invisible to radar.³¹ If stealth technology were so simple everyone would have it.

These descriptions just don't cut the mustard. There was no way to make a remote-controlled device which did all the things reported, and the conspicuous effort was to avoid the categories, "electro-propulsive" and "manned flying saucers".

³⁰Haarmann, D. H. (1983), *Geheime Wundervaffen* (supra); Ratthofer, Norbert Juergen (no date), *Demnaechst "Endkampf um die Erde"*, Vienna, Austria; *Flugscheiben und Andere Deutsche und Japanische Geheim und Wunderwaffen im Zweiten Weltkrieg*, Sierndorf, Austria.

³¹Haarmann, Ratthofer (supra).

2. THE TWO BASIC TYPES OF GERMAN SAUCERS:

1. The ovoidal type, (or "linear type") which flew lengthwise, and included the "Flying Turtles", "Mother Ships", and "egg-shapes" (which in some cases appeared to have more cylindrical shapes, like the "cigar" types, probably due to the necessity to use the most convenient means of fabrication and control at the time); and,

2. the silvery disk type, which flew peripherally, such as the ones seen by my mother, with some alterations to produce the "double-wok" shape seen by us in 1953. There are some very close correlations between the alleged "Vril" ships and those seen by my mother and the entire personnel of the City Hall in Kermit, in 1950, and the ones seen by our entire family in 1953. I have some friends who saw a ship similar to the Vril type (with a slot around its center), near Pecos, New Mexico a few years back.

If the so-called Miethe ship was electro-propulsive, the "12 BMW engines" idea was probably misinformational. A "boundary-layer/flying air conditioning vent"-type ship couldn't have lifted off with the 3" tank cannon and turret alleged, even with 12 BMW engines. The measly vents would have carried insufficient thrust, and the air friction would have literally burned up the ship. Consistent with my mother's information from Roswell and Alamogordo friends in 1948, helium was probably used as fuel in the German KT-p2 ships, which is the probable reason the Zeppelin program was abandoned, since all the helium was needed for flying saucer fuel. Besides, why have Zeppelins when you can have flying saucers, using similar construction techniques? The helium reactors and the KT-p2 ships probably worked as follows:

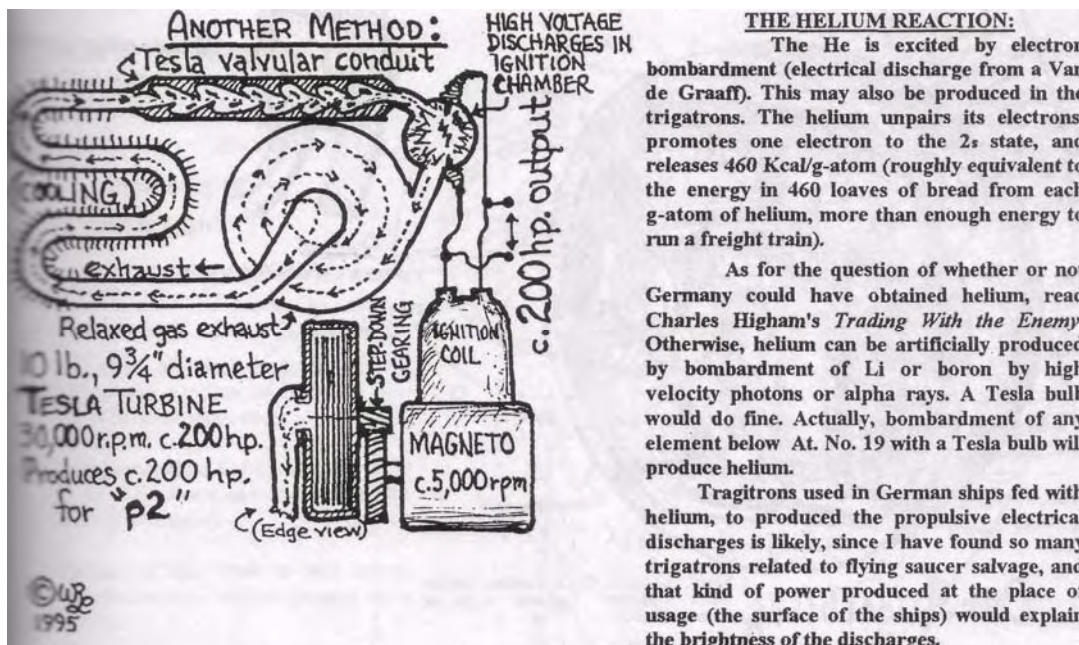

(NOTE: It is probable that a large Tesla coil system (2 coils for each direction, one for AC. and the other for D.C.) surrounded the cockpit area, triggered in 12 peripheral directions by "trigatrons"—triggered, helium-filled spark gaps—fired by 2,500-volt

D.C. trigger currents, actuated by relays connected to the Peiltochterkompass. These could have controlled the discharges on demand, on the hull, thus easing problem of handling such high voltage currents. German technology on trigatrons was first made available to American electrical engineers at large, in 1946³². Very little of this information was declassified even by 1959.

The following illustrations regard my view of various German WWII ships:

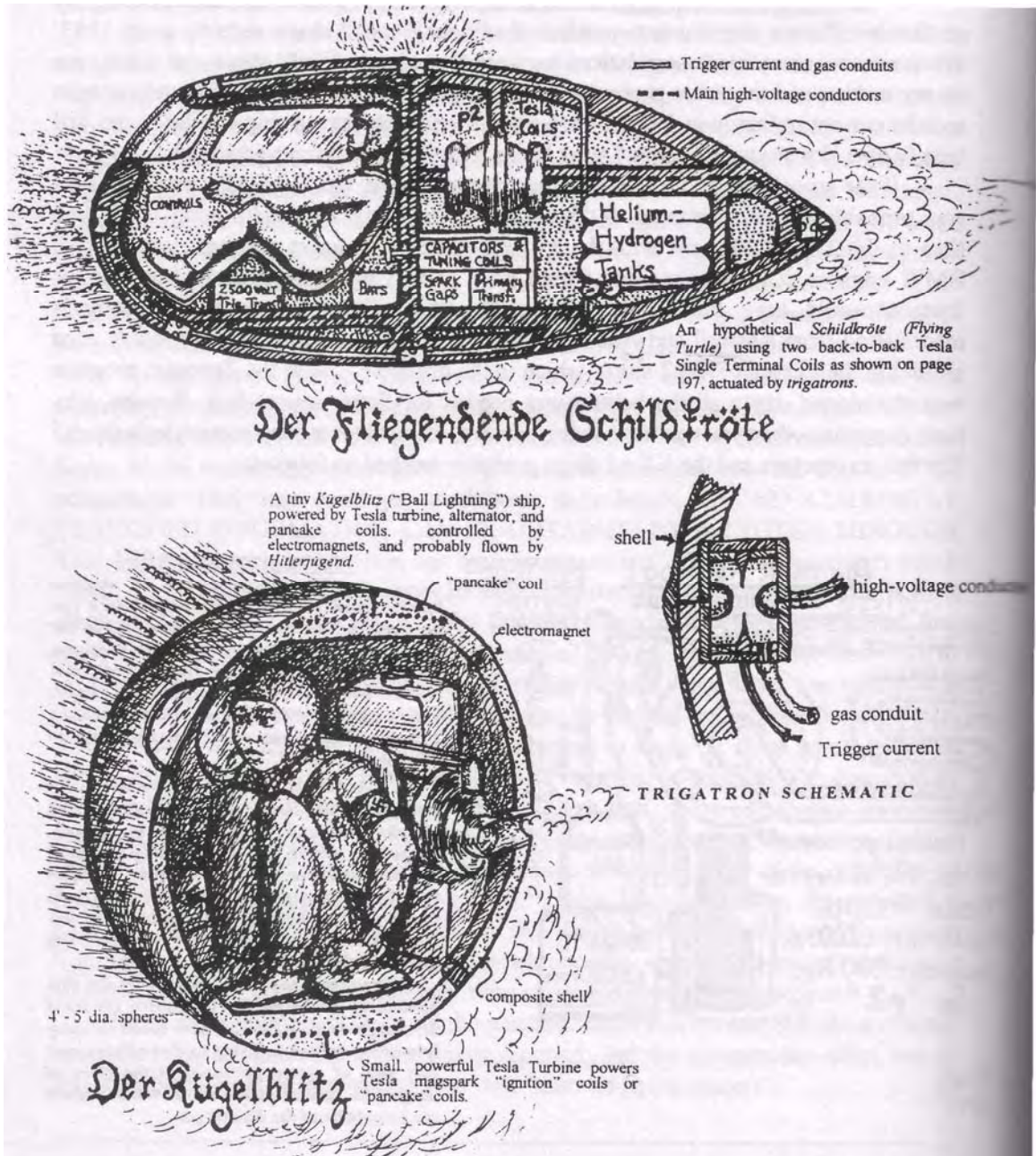

³²Published Proceedings of Institute of Electrical Engineering [Proc. IEE, Vol. 93,1959].

VRIL-TYPE SHIP - KT-p2

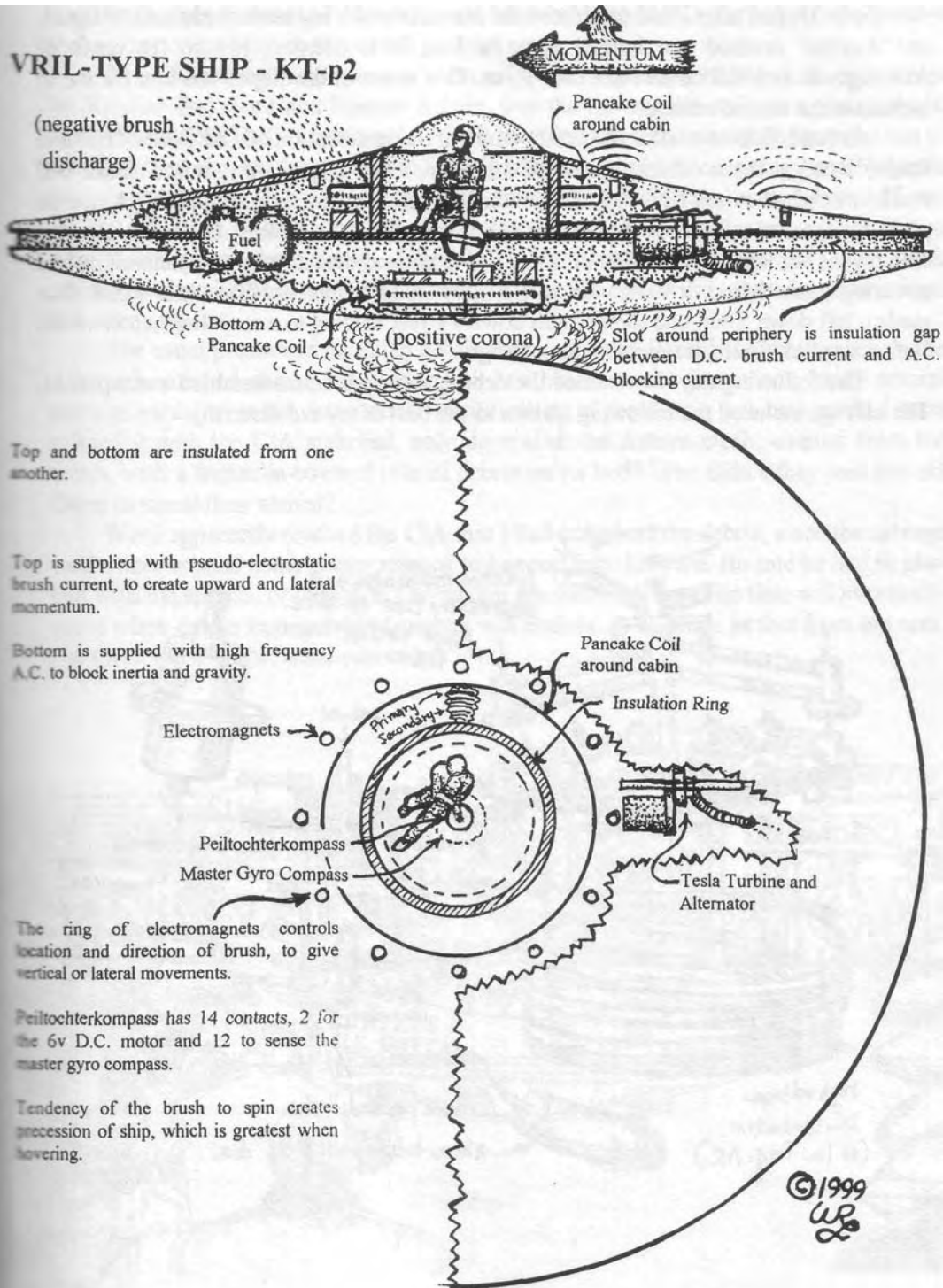

(negative brush discharge)

MOMENTUM

Pancake Coil around cabin

Bottom A.C. Pancake Coil

(positive corona)

Slot around periphery is insulation gap between D.C. brush current and A.C. blocking current.

Top and bottom are insulated from one another.

Top is supplied with pseudo-electrostatic brush current, to create upward and lateral momentum.

Bottom is supplied with high frequency A.C. to block inertia and gravity.

Pancake Coil around cabin

Insulation Ring

Electromagnets

Primary Secondary

Peiltochterkompass

Master Gyro Compass

Tesla Turbine and Alternator

The ring of electromagnets controls location and direction of brush, to give vertical or lateral movements.

Peiltochterkompass has 14 contacts, 2 for the 6v D.C. motor and 12 to sense the master gyro compass.

Tendency of the brush to spin creates precession of ship, which is greatest when hovering.

©1999
L.P.

3. Recent Notes Regarding American UFOs

In 1995, just after I had completed the manuscript for my second edition in August, an "Aurora" crashed and burned near La Luz, New Mexico, just to the north of Alamogordo and Holloman Air Force Base. This material developed too late for me to include in the second edition.

Around five days after the crash, while at the intersection of Old Pecos Trail and Rodeo Road at the southeast corner of Santa Fe, I saw a gray, 'pug-nosed' stake bed truck which had exited I-25 from the south, as it stopped at a light. It had a CIA license plate on the center front of its bumper. As it turned left to go west on Rodeo Road—which goes across the south side of Santa Fe—I noticed that it had a tarpaulin on its bed covering some debris. It went west to Cerrillos Road, turned north to Siler Road, then made a left down Siler, and took a right down a street leading to a recycling center which I often went to. There, it unloaded its 'salvage'.

The following day, I examined the debris, and even disassembled a component. The salvage included the following (drawn to the best of my recollection):

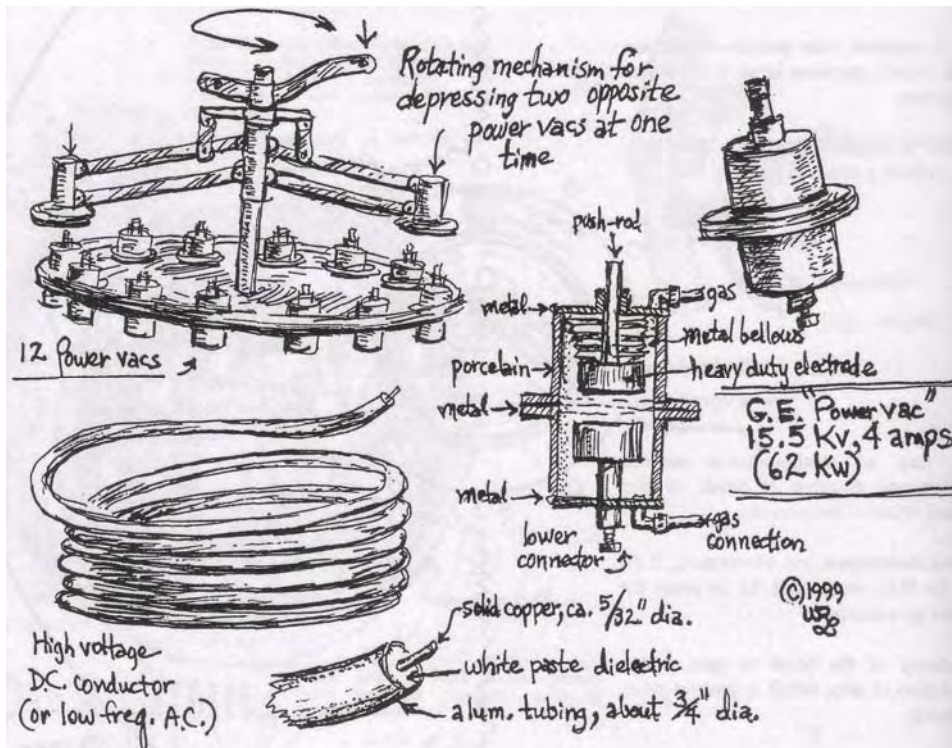

The debris was blackened from the burning, and someone had taken a sledge hammer to the dish, in attempt to deface it, but failed to break a single "power-vac". The entire assembly appeared to be a high-amperage switching system which carried 15.5 Kv current to two places at a time, totalling twelve in all, in bipolar pairs. This seemed to confirm the rumor that the "Aurora" could hover and use "UFO-like" electro-propulsive technology, in addition to its normal turbojet power.

It is interesting that the name "Aurora" is used for this craft, since the discoveries by Kristian Birkeland and Hannes Alfven, that the Aurora Borealis is a giant current from the sun into Earth's north pole, which transfers angular momentum from the sun to the earth, and showed the relation to Tesla's electro-propulsive technology and Dynamic Theory of Gravity. The principle was illustrated by the sighting made by myself and several others as I sat in a hot tub at the Ten Thousand Waves Japanese Bath House near Santa Fe, on the evening of Jan. 26, 1996 (illustrated on page 181). The brush discharge extended above and ahead of the ship as momentum was transferred to it from the ether carriers.

The usual practice in handling debris from a crashed classified aircraft, such as the Aurora mentioned above, is to separate it and haul it to the four winds, using several salvage yards, to avoid detection or identification of the debris, but how could I have missed it with the CIA stakebed, only days after the Aurora crash, coming from the south, with a tarpaulin-covered pile of debris on its bed? Why didn't they just fire off flares to signal their arrival?

Word apparently reached the CIA that I had examined the debris, since the salvage yard owner created some phony reasons to ban me from his yard. He said he had to play ball with the spooks, or they won't bring him any more salvage. The time will eventually come when debris from salvaged saucers will become as common as that from old cars, and there will even be "used saucer lots".

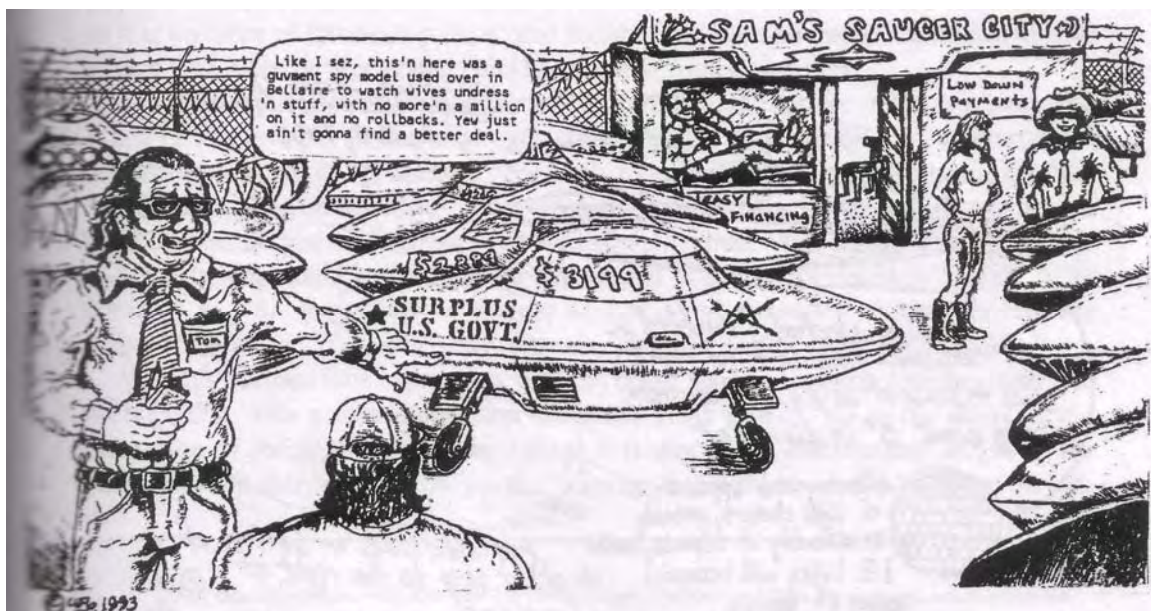

The oblong, lozenge-shaped ship with rounded edges, was about 10,000 feet away, and executed a perfect, circular flight in around ten seconds. Since its circle was around 30 degrees across, its speed was around 2,000 mph. It was around 3/4" long at arm's length, which means that it was around 400 feet long, about 250 feet wide, and appeared to be about 50 feet thick. In other words, the ship was about the size of a five-story building which occupied the shape of the area inside the track around a football field.

On July 19, 1998, 9:21 P.M., my son and I sighted a couple of huge, saucer-shaped ships, as we exited Furr 's Food Emporium, a large grocery store on St. Michael's Drive, on the southeast side of Santa Fe. The ships were hovering and maneuvering between Santa Fe and the 'tech' areas to the south of Los Alamos National Laboratory. Due to the apparent distance to these ships—at least five miles—and their relative size, they were very large, several hundred feet across.

One ship hovered horizontally for a short time, while the other appeared to be hovering at an angle, showing its bottom, which had four large, red lights on it. The horizontal ship had a single row of red lights around its middle, in what appeared to be a trough. These round red lights, which had to be around five to ten feet in diameter, 'throbbed' in sequence, from left to right, becoming bright then dim, one after the other. These were apparently to stabilize the ship's precession, and the fact that they 'throbbed'—increased and diminished gradually in power, rather than "flashed" abruptly—indicated that they smoothed out the transition of force from one electrode to another. This would produce a more stable effect to counteract the precession problem.

The large lights each had a hexagonal, 'honeycomb-like' pattern, indicating that they were composed of many smaller infra-red lights, each mounted in hexagonal frames. This was probably because of the difficulty in getting larger I.R. lights, and the fact that, even though one light might burn out, the others would remain to function until the burnt out lights could be replaced. The I.R. emissions seem to have the opposite effect on the brush as a magnetic field, inducing the brush to follow the beam to counteract its tendency to spin, since the spinning creates the precession when the ship is hovering. The I.R. lights are to stabilize the ships. Here is a simplified drawing:

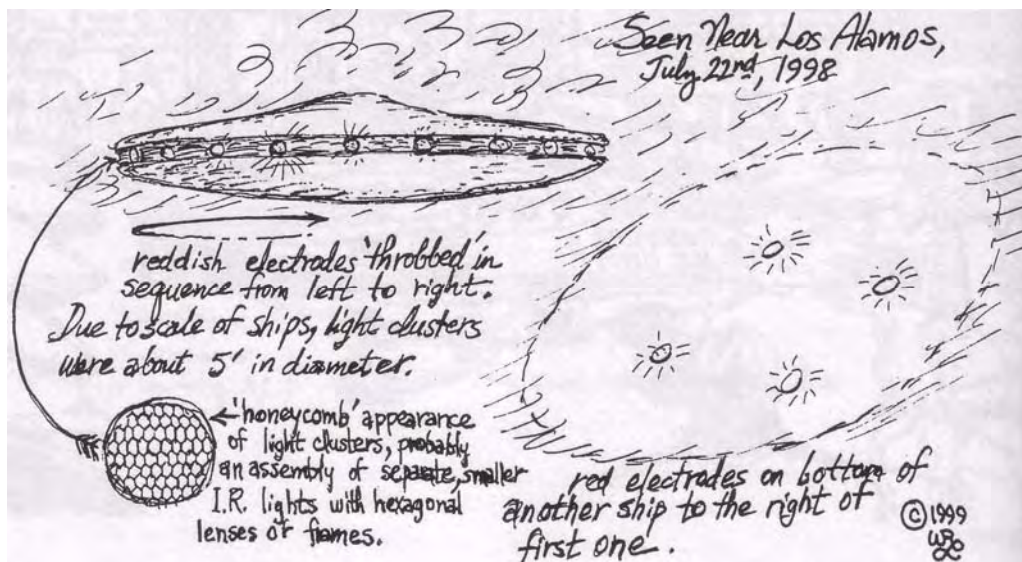

4. MY FLYING SAUCER DRAWINGS AND PLANS:

Preliminary Technical Background

Having determined that a DC. brush discharge induces movement in the direction it is pointed, by "rarifying" and stretching the ether, Tesla did intensive research with the phenomenon of rotating brush discharge, and how it can be controlled.³³ This research led up to Tesla's proof of concept, by 1894. The rotation of the brush, caused by rotation of a magnetic field, is the apparent cause of precession of spinning bodies, and of non-spinning flying saucers. Since the brush induces movement in the direction pointed, its rotation causes the precessive oscillations. This is also consistent with the rotation of the brush clockwise in the northern hemisphere, and counterclockwise in the southern hemisphere. Since a spinning body carries electrostatic charges as it spins, it generates an invisible brush which moves at a slower rpm, to create precessive movement. Here, Tesla artificially created a rotating brush by inductance, in a non-spinning body.

P² (or p2) is apparently two primaries, since two identical pancake secondaries can respond at different wave forms, determined by tuning in each of the two primaries. At one-quarter wave, the secondary will create a D.C. brush discharge. Referring to the illustration on page 197, Tesla's patent #723,188, Method of Signalling, P¹ and P² are the two differently tuned pancake coil primaries, each having identical secondaries, run on the same system, which makes them appropriate for electropulsion.

An electrostatic generator is unwieldy and has a low output for its size. The problem Tesla faced was how to produce a pseudo-electrostatic D.C. brush with his small, light-weight high frequency coils. In reiteration, in the page 197 illustration, the coil to the left can be tuned to a quarter wavelength, to produce the brush discharge, while the coil to the right is tuned to a half or full wave, constituting a high frequency alternating current. The brush enables the ether carriers and tubes of force to enter the ship's conductors (the metallic shell), while the other coil compresses the ether carriers so that no tubes of force can pass, so that the ship will have no inertial resistance to hold it back, and it can be accelerated quickly as well as turned on a dime.

Since the direction of momentum will be normal to the surface of the conductor, the brush can be diverted around a curved surface which is perpendicular to the direction of desired movement. It was necessary for Tesla to learn how to control the position of the brush, since a brush-control system (magnets) would make it unnecessary to have a cumbersome system of different coils for every direction. With a simple two electrode system, the ship could be propelled in any desired direction. As stated by Tesla³⁴, "The rotation may be reversed by a magnet kept at some distance. " "...the fact that the brush turns, as far as I could observe, in any position, would speak for this view."

In his vacuum tube experiments with the brush, using concentric (double, inner and outer) bulbs, with a central emission electrode, Tesla stated: "As to the cause of the formation of the brush or stream, I think it is due to the electrostatic action of the globe and the dissymetry of the parts... ", saying that if the two bulbs had been perfect,

³³Nikola Tesla, Experiments with Alternate Currents of High Potential and High Frequency (Lecture before the Institute of Electrical Engineers, London, 1892) McGraw Publishing Co., New York (1904).

³⁴Nikola Tesla, Experiments, etc. (Supra) p. 48.

concentric spheres, with identical quality and thickness of glass, he thought the brush would not form, since "...the tendency to pass would be equal on all sides. "

In 1899, after the London lecture, Tesla stated that he had developed what he called his "single terminal coil"³⁵. The new coil, which could be in a cone shape or of the "pancake" type, could be tuned to one-quarter wave to produce the brush discharge by means of impulses which have a negative preponderance, or tuned to the half or full wave, to produce the high frequency A.C. current. As said by Tesla earlier³⁶, "...in alternating currents of very high frequency the positive and negative impulses are not equal, but that one always preponderates over the other. "

The D.C. nature of high frequency quarter-wave pulses have been similarly analyzed in modern times³⁷, as follows (in pertinent part, emphasis mine): "Since electromagnetic effects are not transmitted instantly from point to point in space...there is a time lag between changes in charge and current distribution on the dipole" which "...allows some of the energy to continue flowing outward even though conditions at the dipole may have changed to indicate an inward flow of energy...as if some of the electric and magnetic field has become detached from the dipole or 'shaken off' by the oscillation. " The intensity of the emitted wave is dependent upon the increased frequency, and the time lag becomes more significant, since "...the power radiated varies as the fourth power of the frequency. "

Tesla moved his primary to the outside of his new "single terminal coil", with each turn of the secondary (inside it) having progressively increased spacing and insulation, as the potential increased between the turns, toward its single center terminal. This allowed for higher voltages with greater effect, since the vector product of the electric and magnetic force in a region of space determines the extent of electromagnetic momentum imparted.³⁸ Since, as Thomson said, momentum is imparted to conductors at right angles to the magnetic inductance and current, it naturally follows that Tesla's single terminal pancake coil is most appropriate, because its flat profile allow it to be conveniently positioned in the ship's peripheral spaces, parallel to and inside its outer surfaces, which conserves space inside.

The first of my proposed ships, of ultimate simplicity, has an electromagnetic turning system, with two coils used for vertical buoyancy, and two coils used for horizontal flight. Two sets of electromagnets mounted peripherally to the front coil are used to divert the brush to the right or left.

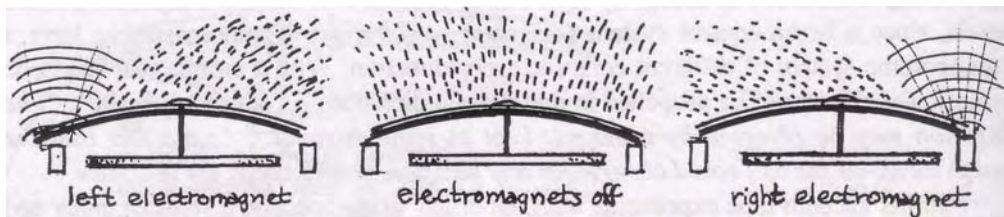

³⁵Nikola Tesla, Letter, Some Experiments in Tesla's Laboratory with Currents of High Potential and High Frequency ELECTRICAL REVIEW, N. Y. (1899).

³⁶Nikola Tesla, Experiments, etc. (supra).

³⁷R. L. Armstrong & J. D. King, The Electromagnetic Interaction, Prentiss-Hall, Englewood Cliffs, N. J. (1973).

³⁸J. J. Thomson (supra).

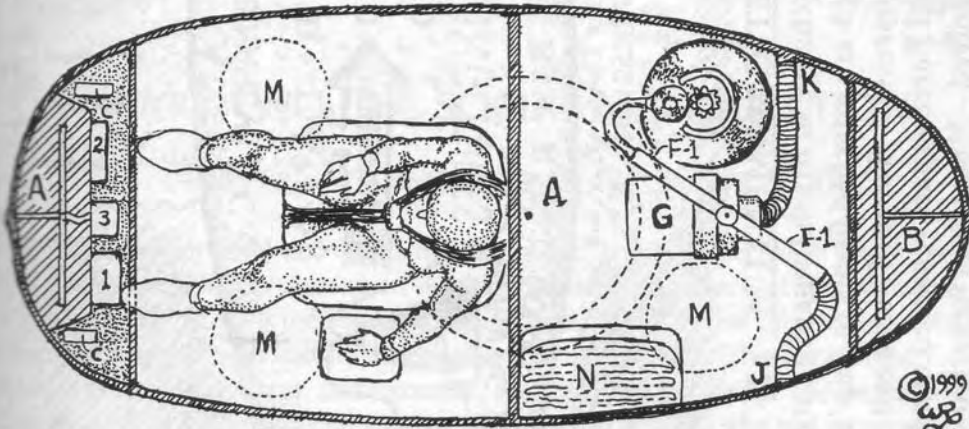
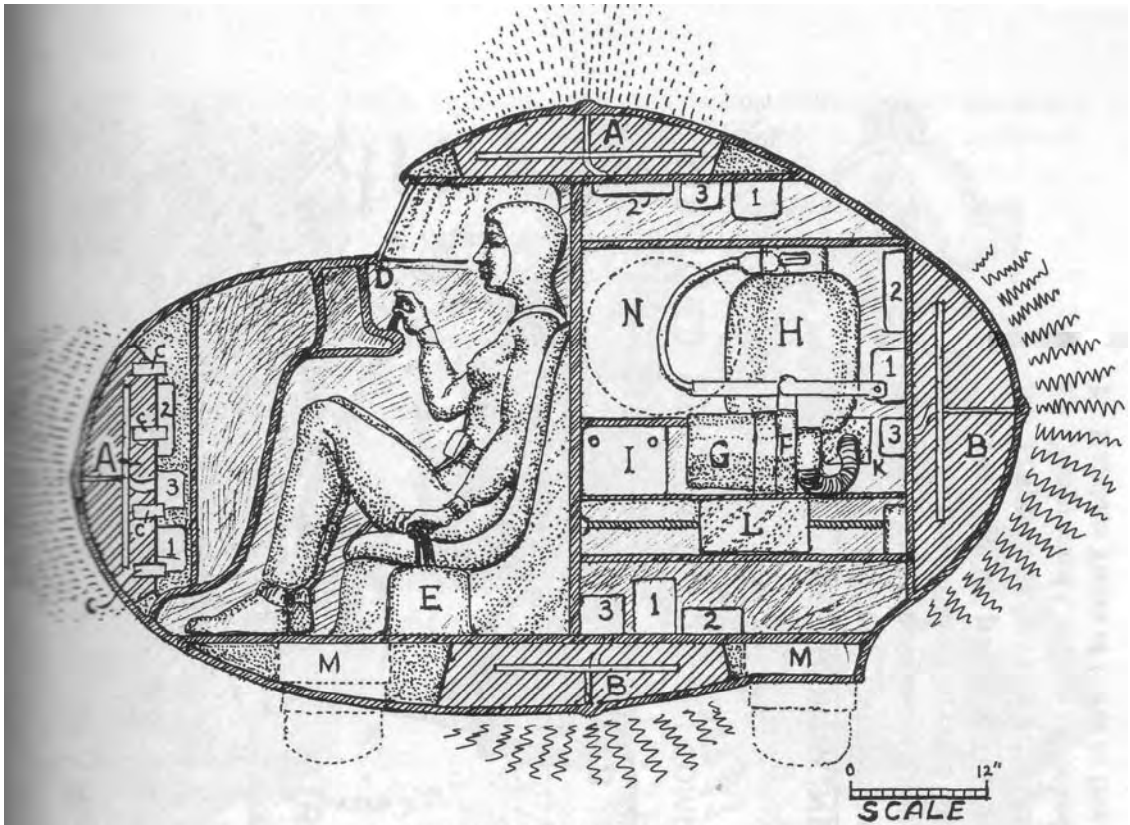

THE FIREFLY

A - D.C. Brush Pancake Coil Modules

- 1 - transformers
- 2 - capacitors
- 3 - spark gaps

B - High Freq. A.C. Pancake Coil Modules

- 1 - transformers
- 2 - capacitors
- 3 - spark gaps

C - brush control electromagnets

D - Turn Control Joystick

E - Power and Vertical Controls

F - Tesla Turbine

F-1 - Valvular Conduits

G - Alternator

H - Propane Fuel Tank

I - Battery

J - Engine Air Intake

K - Engine Exhaust

L - Adjustable Ballast & Servo

M - Pneumatic Landing Buffers

N - Emergency Ballistic Chute

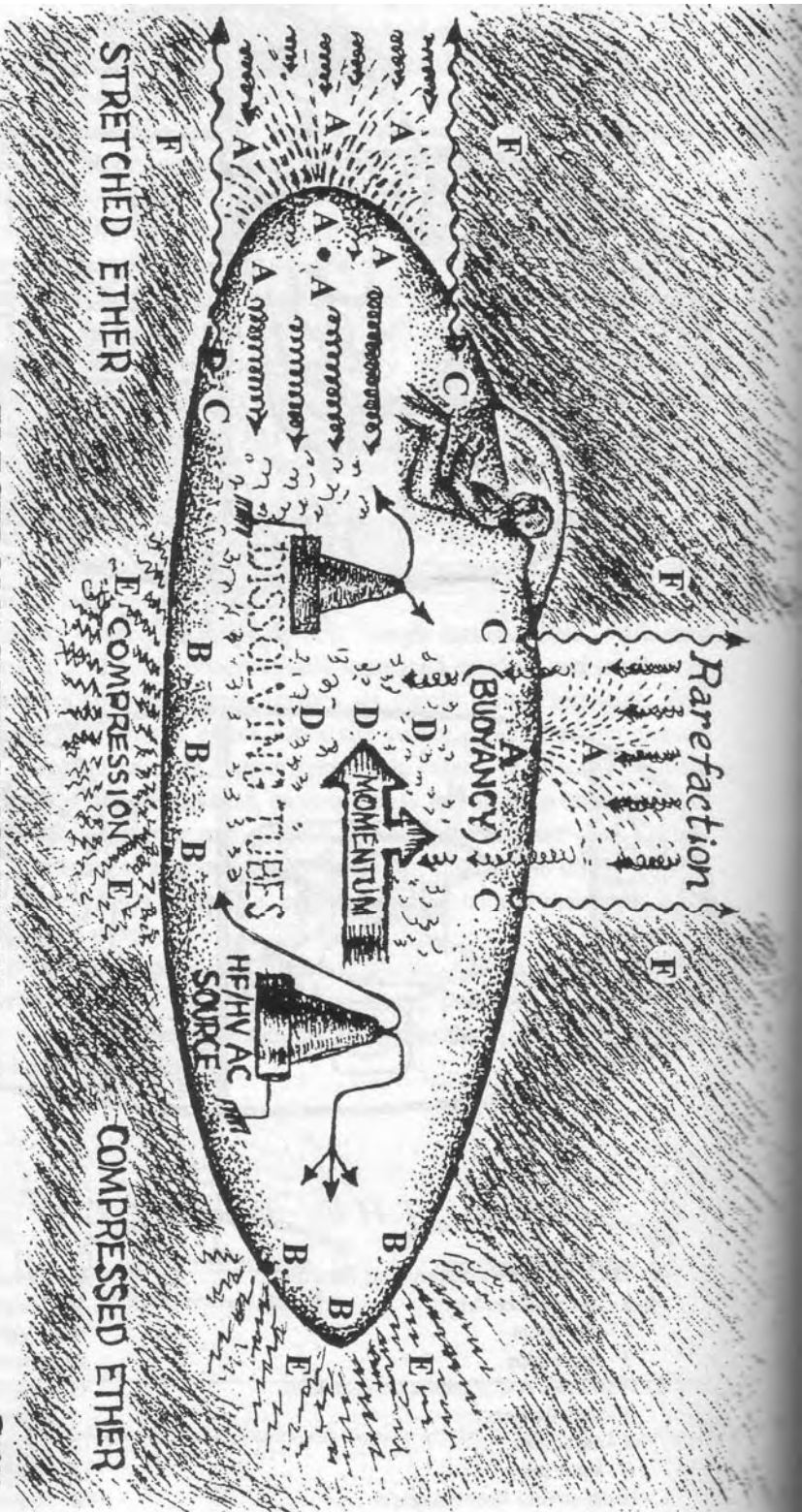

ELECTROMAGNETIC MOMENTUM - p2:

- A - D.C. Potential - Carriers exchange in Brush (negative corona) - Tubes of Force enter conductors which are attached firmly to ship's structure
- B - A.C. Potential - Carriers compressed - Tubes of Force exit blocked
- C - Tesla Bulbs polarize Tubes of Force - space rendered conductive
- D - Trapped Tubes of Force Dissolved - Momentum imparted at 10^{40} x fg
- E - Compressed Carriers - Blocked Tubes - (positive A.C. corona)
- F - Random Tubes of Force in free space

©1998

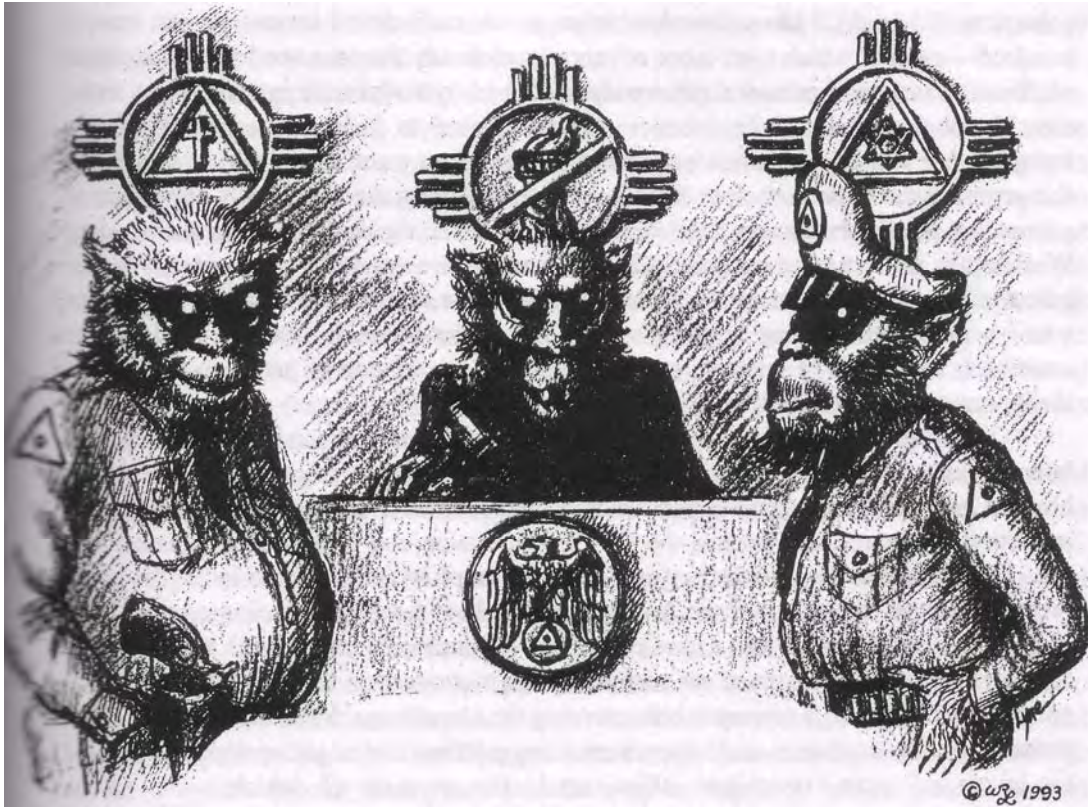
PART TWO: THE SOCIAL MANIPULATION

CHAPTER VI: CANNIBALISTIC FASCIST LITIGATION

Between 1986 and 1992, my family and I were subjected to intense judicial harassment which had nothing to do with the subject matters of approximately six fraudulent and abusive judicial proceedings filed against me or otherwise government instigated, which were mostly disguised as "property" suits. This harassment took up almost all my time, energy, and resources, and destroyed my family. The lead attorney in this abuse was a Jesuit-trained attorney of Sicilian extraction, who had prosecuted G.I.s for the J.A.G., during the Vietnam War. The Jesuits are especially known for their collaboration with the CIA's mind-control experiments such as the MK ULTRA Project.¹ This attorney was what I would call a "judicial torture specialist". Every horrible, dirty, underhanded, cheap trick imaginable was used in this litigation, and the CIA's involvement was obviated by the immunity from judicial discipline which the perpetrators enjoyed, in spite of their overtly unethical conduct before the New Mexico courts, as well as the joyous, sadistic relish with which the judicial turds carried the dirty dealings out in the name of "justice".

During the same approximate period of time, I filed a patent application which was to 'sound out' the patent office to either obtain a patent or see if the P.T.O. is really as

¹Cathy O'Brien and Mark Phillips, *Trance-Formation of America*

corrupt as I'd heard. I have numerous other novel, undisclosed inventions—at least a hundred—most of which were more advanced technically than the one I sought a patent on, but the simpler mechanical, thermodynamic and hydrodynamic invention was more clearly novel, and would be a better sounding board to feel out the patent office's integrity. My strategy was also designed to avoid exposing a more valuable invention to the prying eyes of the corporate-state monopolists, during the supposedly secret patent proceeding. Patent examiners have their many offices in the outlying areas surrounding Washington, D.C., tucked away in little offices which are not under close scrutiny by the patent office. The examiners often have semi-illiterate or mentally retarded secretaries who have no idea of what is going on, so that under-the-table dealings between the examiners and the large interests can be conducted, in violation of patent rules, without the ignorant secretaries getting wise.

One invention I had developed in 1978 had already been stolen by a creep who had been given a new, false identity in America, by the U.S. Army C.I.C., after being brought here under Operation Paperclip at the end of WWII. His specialty seemed to be industrial espionage, and he had the CIA's cooperation and protection in whatever he did. I later received confirmation that the CIA employs such people in an on-going program to steal technology from inventors to be sold to fund their black operations.

The stolen invention was a new kind of solar voltaic cell, created with a new kind of construction technique carried out with a new mass-production technique for producing solar voltaic chips on a conveyor belt, carrying the chips through several chambers. The process used hydrofluoric acid vapor, containing positive and negative dopants, applied to layers of pure, crystalline silica sand, the crystals of which were to be electromagnetically polarized and positioned, before being fused with microwaves. Between the silica crystals, layers of 'sputtered' metals were applied for conductivity. I chose hydrofluoric acid vapor to carry the dopants, since it would etch them into the sand crystals. The process eliminated the very expensive and tedious process involving the growing of silicone crystals in a high temperature furnace, after which the crystals had to be sliced into thin wafers with a diamond saw. Instead, I used silica sand crystals produced in nature. In addition, my automated process was designed to further decrease the price of the cells. Cheap, but durable materials and processes were used throughout. This process became the new industry standard, and has made \$millions—maybe even \$billions—for the CIA-friendly industrialists.

Within 10 days of the theft of my plans for this invention, a Michigan pal of the thief filed a patent application. The thief also stole over 80 ounces of highly purified iridium (a platinum group metal, worth over \$80,000.00 at the time), which I had extracted from ore concentrate, at great risk to my life and health under the circumstances. The patent neglected to include the part about using pure silica sand, and used only the more usual sliced crystal wafers, along with the rest of my ingenious new process. I reasoned that the exclusion of the sand technology was because it has the capacity to make solar voltaic cells so cheap that you could use them as roof shingles, and the invention would become public domain in only 17 years. Such a technology would soon greatly diminish dependency on fossil fuels and electric power companies.

The patent concentrated on my manufacturing process, which increased the efficiency of solar voltaic cells by almost 100%—from around 12-14% to 25%. The invention was then sold to ARCO, a company created by Robert O. Anderson of Roswell, former president of the Bilderberg Group, as I have already mentioned.

The proceeds of this sale were apparently shared by the CIA and its technology thieves, phony inventors, and developers.

My patent application—the one for the transmission invention—was for an off-the-shelf, universal, variable, dynamic transmission, which could be produced as an hydraulic or pneumatic one, in a multitude of forms and sizes. I knew that there was nothing like it on the market or in the patent office, though there were several inventions which had come close, passing right by it, yet missing it completely. Some had parts or sections similar to it, used in ways that showed a complete unawareness of the simple invention lying only inches away. Due to their failures to see the invention, their inventions were no more than inoperable and inefficient conglomerations. My drawings and basic parts of the application and invention are shown in Appendix A. I dedicated this invention to the public in my first edition of 1993, to prevent the corporate thieves from profiting from it or keeping it out of public use.

I knew that under the constitution, the patent office was obligated to grant a patent on this invention, once it became apparent that it was a valuable, novel creation like no other.

By allowing corporate thieves a preliminary look at a patent application, they can decide whether or not they are interested in it. If so, the examiner can run the applicant ragged with all kinds of bureaucratic procedures and fees, intended to force him to abandon his application. Once the applicant abandons his application, the corporation can apply for a patent on the exact, same, identical invention, receive a patent, and grease the palm of the examiner. This prevents the public from using the invention for at least 20 years (about three years are taken up in applying for the patent, and an additional 17 years are added to that), thus slowing down progress, so that the vested interests can continue to promulgate their archaic technology. By the end of that time, if the corporation has chosen not to put the invention into service, it is usually forgotten about.

There I was with a series of CIA-instigated abusive lawsuits against me, and at the same time, a pending patent application. Between the Oct. 25, 1978 invention and metals theft, and the 1993 publication of the first edition of this book, at least four murder attempts were made against me, all of which I could connect to the CIA and its technology thieves. There were probably more murder attempts than that, but the other attempts were more difficult to identify. One of the murder attempts consisted of having children give me food in a restaurant which was contaminated with salmonella, on the same day that a "notice of abandonment" was mailed by the patent examiner from Washington, D.C. The only people who could have known of the mailing of the notice, were those the examiner told, in violation of the rule of secrecy. That occurred in 1992, at which time I began writing this book in earnest, with the determination to publish it, since another murder attempt could succeed, and it would be attributed to "natural causes", and no one would ever know why.

The courts, through a series of judicially corrupt and abusive orders, based on lies, repeatedly held me in contempt without notice or hearing, struck pleadings necessary to protect my civil and property rights, and prohibited me from filing pleadings, in violation of my due process rights. They deprived me of some of my property, forced the abandonment of a patent application, destroyed my family, and subjected all four of us to vicious, treacherous and abusive orders, manipulation, anxiety attack, and intentionally inflicted emotional, physical, mental and economic distress. They

impoverished me and sapped my physical, emotional, financial and mental resources. I wanted, and still want, revenge. Can you blame me?

The local trash who carried out these filthy acts were small-time toadies, drug dealers, money-grubbers, property thieves, trashy and crooked realtors, title examiners and insurers, yeggs, and socialist bureaucrats. The people who directed this "machine", were part of a corporate-statist, coercive-monopolist, fascist elite. What this elite fears most is a truly free, creative, laissez-faire, free-market economy, in which a broad base of people participate and prosper. Their "machine" is designed to maintain their control. My many unpatented inventions were the result of intensive research and creative activity I engaged in between 1976 and 1986—ten years. It is my intent to give these inventions to the public to further punish the elite, along with this expose of flying saucer electric propulsion technology, as my revenge for having subjected my family and me to the judicial abuse and deprivation of presence of mind, money, civil rights, human rights, and property.

The civil judicial system is a trap devised by corporate-statists, to ensnare and devour all those whose interests conflict with theirs'. The involvement of the N.S.A. and CIA is incidental to their functions as pawns in the game, under Trilateral Commission orders, to protect the corporate/state alliance from damaging scientific and technological breakthroughs and leaks.

The President is a member of the Trilateral Commission, and he gives the orders which the Commission gives to him. An example of the behavior of this hierarchy is the Gulf War bombings of Iraq in 1992 and 1998. The IMF and Bilderbergers want possession of Russia's natural resources and basic industries, such as the phone system and other utilities—the things people must pay for every day—the same things the elite owns here. Russia's loans from the IMF seem to be unsecured, as the Russians have held back on using their major national resources as collateral, while trying to get on their feet as a free market economy. The elite wants them to use their vast natural resources and utility concessions as collateral for their IMF loans, so they can be induced to default on their loans, with the elite then coming into possession of these resources through bankruptcy and foreclosure procedures.

Russia has an oil deal with Iraq which they need to achieve a valid credit rating, and to pay off existing IMF loans which are continually overdue. The Russians are on their knees, and the IMF and Bilderbergers do not intend to let them get on their feet until they control Russia's natural resources, the same as they control them in America. The bombings of Iraq are designed to prevent Russia's recovery, and primarily have nothing to do with anything else. The impeachment proceedings against President Bill Clinton have been designed to turn the heat up to force him to bomb Iraq for the Banksters. That way, the Russian-Iraqi oil deal will go sour and the Russians will be unable to repay their loans. It is hoped that, through this continual ruin of Russia's attempts to succeed as a free market economy, the Russians will eventually be forced to surrender their resources to the Banksters.

Now that Clinton has bombed the Iraqis once more, he probably won't be impeached. After all, the whole series of incidents involving Monica Lewinsky were orchestrated through a Pentagon set-up, in which a Pentagon employee—Linda Tripp—tape-record her conversations with Monica Lewinsky, another Pentagon employee. This could not have occurred without the approval of national security authorities, something which has never been mentioned in the whole mess. Otherwise, for one Pentagon

employee to tape record their conversations with another, regarding the President, would be considered as espionage.

With the supposed crumbling of socialism, the American civil judicial system remains as a disguised means for a secret corporate-socialist state to continue to force its will upon those in its disfavor, favoring litigants within the parameters of its secret agenda, and denying the claims of those who are not. On the face of it, since this system serves only the elite, and provides no benefits to the ordinary American, the system should be abolished, and our rights restored. This includes ending the emergency status which has been protracted to suspend our rights since 1933 (though some think since 1913). We ordinary Americans should not support a civil judicial system which fails to support us and is only for the powerful to keep us under their control. It has been abolishing our natural rights for some time, and should itself be abolished. It no longer serves the interests of the people, and has broken down. We are the damned bosses, and have no duty to serve "the system".

Legitimate conflicts should be handled through a private criminal justice restitution system, or private civil court system, devoid of corporate-socialist conflicts of interest. Only cases which meet a preliminary burden of criminal jurisdiction should be allowed to be filed. The rest should be resolved by mediation, or perhaps "Tanistry" (the ancient Irish system based on Phoenician law).

With these suggestions in mind, we are now going to play a new game, in the following three parts, which I call (1) "The Ninth Amendment Quiet Game", (2) "The Article One (Sec. 8, cl [8], and the Fifth and Fourteenth Amendments Property Game", and (3) "The First Amendment End-Run Game" (also referred to as "The Ol' Statute of Liberty Play").

The Patent and Trademark Office's ("P.T.O.'s") rules are designed to loot isolated, individual, dreamer-type—typically eccentric or naive—inventors, some of whom may have only one good idea in their entire lives. Like beneficial insects being ensnared by giant, evil spiders, they are lured into the trap, encouraged by government/corporate propaganda, to seek patents. Corporations, which invent NOTHING (except high-toned slogans and logos), collaborate with the Patent Office, successfully stealing inventions from a steady flow of inventor-sucker applicants with stars in their eyes. This book blows the cover on that scam.

The creativity which has been the hallmark of the American experience is rapidly diminishing with the oppression of our creative people, by denying fair compensation and credit, while exploiting their creative products. Inventors come to the P.T.O. as trusting fools, and under its weird rules, the P.T.O. stabs them in their backs, helping the corporate thieves steal their inventions. If these inventors had other inventions—which most of them do—they would make no further disclosures—which most of them don't—in order to avoid repeating the trauma and disappointment of multiple "patent rape" by the U.S. government and corporate state. I can now speak for these hapless inventors, since I was among them.

While not all inventors' claims are valid, the P.T.O. condescendingly grants many token patents for worthless, inoperable 'paper' inventions, simply because the applications are filed by patent attorneys, conform to the P.T.O.'s weird bureaucratic idea of proper applications, and present no real threat to the vested interests. Though such inventions may be harmless, inoperable devices, the patents may contain disclosures which work to the benefit of the corporations, by creating the false illusion

that the 'little fellah' has rights too, provided he goes into hock for a high-priced PATENT ATTORNEY. This false illusion helps maintain the flow of suckers to the patent office. Meanwhile, more valuable applications are denied for purely formal reasons, since the inventions are to end up in the hands of corporate thieves, who may at their whims suppress or confiscate them, obliterating the true inventors with a wall of litigation they cannot even begin to penetrate. Though I have been abused many times by my government, I refuse to dissolve in despair like so many others whom the P.T.O. and the civil litigation system have permanently crushed.

A patent as we know it does not secure anything, except the right to attempt to enforce it in court. The true nature of the right is the inalienable property right of an inventor, to the disposition of wealth he created. Property rights are not created by the government, and an inventor owns his invention whether or not the government grants a patent, which is not true security. "Invention" is an individual, creative process. While we patronize—purely as a legal fiction—that corporations are individuals, we should not extend this fiction to consider them to be inventors of creative products. Corporations should be absolutely prohibited from seeking a patent, or from holding a patent or the rights to one, until after a patent has been granted to the true individual inventor(s). Furthermore, the P.T.O., under our Congress—which is constitutionally mandated with the duty to secure to inventors the properties of their inventions—should have their provisions completely restructured to accomplish the exact constitutional mandate, no ifs, ands, or buts. It is well-known to every real inventor in America, that the system fails to work as intended, and must be changed for the better or abolished.

A. THE REAL ISSUES: THE WAVE OF THE FUTURE

The groundswells in the EAST are moving toward us like a TIDAL WAVE, which the bureaucrats will be caught up in for the same reasons as their Soviet counterparts; they will eventually have to find some form of productive work, after a flabby lifetime of sponging off the taxpayers; many bureaucrats who anticipate the future are already engaged in damage control. (It is even rumored that they are wearing bullet-proof underwear.) A bureaucrat of any kind will never be anything but a leech to the common man. In every socialistic society, the bureaucrats are the disgusting toadies who sell out their fellow citizens, in exchange for a small share of the loot stolen by the power elite. Bureaucrats are not entitled to gloat over the failure of the communist system, since people who live in glass houses shouldn't throw rocks. The issue is not simply whether the state permits religious freedom—as some would like for you to believe—but whether governments have legitimate power to execute, imprison, or punish citizens, or to confiscate their money ('taxes'), or property (or inventions), or in general, their wealth, for the "public good", for bureaucratic convenience, or for the political recalcitrance of their owners or creators, by having disbelieved, mistrusted, or defied the government, or for having refused to obey, or to believe what their government ordered them to believe, or for having followed or advocated a political philosophy or personal, moral lifestyle which was officially declared to be undesirable or prohibited, even though legal; or for having simply asked the question of whether bureaucrats really serve the interests of everyone; or for having suggested that they serve only their own interests and those of an American corporate oligarchy, similar to that which ruled Soviet Russia or Nazi

Germany, and still rules certain Central and South American countries (such as "United Fruit Company"), or China (i.e., such as "EXXON", or the "Communist Party", etc.); or for suggesting that they represent illegitimate, usurped authority of a corporate-fascist state, rather than the proper, constitutionally-ordained, limited power delegated by self-governing, sovereign individuals, who lack the authority or right to delegate more authority to any government; and finally, whether such agencies as the P.T.O. operate in conformance with their duties to the American People, which the Constitution originally mandated Congress to enforce.

We can never have a "kinder, gentler society", so long as there is a gestapo-like I.R.S. to force us to pay for the extermination of Iraqis who are in the way of the Trilateral Commission's plan to confiscate the natural resources, monetary system, and industries of Russia, or so long as the doctrine of eminent domain is legal in America.

So-called communist states are in reality, corporate states. Chernobyl was no accident, but rather the inevitable result of corporate-state arrogance, brittleness, recklessness, irresponsibility, negligence, oversight, and insanity, born of seemingly immutable and concentrated monolithic power. The corporate-statist Federal Reserve Banksters exert coercion through police-state agencies like the I.R.S., F.B.I., C.I.A., N.S.A., A.E.C., D.O.E., N.R.C., and S.E.C. etc., to enforce exclusive commercial, industrial, or governmental franchises granted either by or to the state, or through partnerships with the select corporate providers of "public services", who enjoy matrimonial bliss in the convenient (for them, not for us) fascist marriage between "...the state and industry...". In Soviet Russia, the corporations were composed only of members of the Communist Party. Here, the party is replaced by "public corporations", which differ only to the extent of a greater amount of mixed-economy socialism, and some possible token collectivistic participation by the public as "stockholders".

To induce productivity of inventors, public policy must reflect a false illusion of freedom and opportunity, so that the trust of inventors can be maintained. After all, if the people don't present the illusion of freedom, who will trust the Patent Office?

Like their Soviet counterparts, the American government enhances corporate-state power, by assuring the accumulation of technologically creative products by coercive-monopolist corporate partners, through fraud upon individual creative people and the people as a whole. By misfeasance and abuse of the powers of Congress, under U.S. Const. Art. 1, sec. 8 cl. [8], the Patent Office promises a patent under the Constitution, as a means of enforcing a seventeen-year monopoly through litigation, in the name of the inventor, as an inducement for inventors to disclose and to share their discoveries with society, for the advancement of science and the useful arts; that is their "bait". But the P.T.O.'s real bosses are not "the people", any more than those of the Soviet bureaucracy. Its rules have been redesigned since the days of Jefferson and Franklin.

Patent applications are like ripe plums to the elite, all for the picking. Any significant energy, transportation or manufacturing breakthrough automatically becomes a national security secret, which allows the government to remove all evidence of a patent application, to confiscate the invention, and to prohibit disclosures to the public under the secrecy acts. After confiscation, the work is then turned over to the usual corporate-state companies, so they can manufacture secret equipment to be sold to the government at huge profit.

An example was the invention of an artificial fish gill, which separates hydrogen and oxygen in water, on contact, and could be used to power a hydrogen-powered car, etc. (NOTE: Paradoxically, the taking of such discoveries by the secret government, in our name, obliterates our knowledge of the technology. Nonetheless, it becomes public domain one year after the government's acquisition—by about 1974 for the fish gill device—but since such secrets are rarely declassified, we may never know about them.). Other discoveries, which cannot be construed as national security secrets, are steered into the hands of their corporate partners through abuse of P.T.O. procedures, to the disparagement of the individuals who created them, and to the detriment of the public.

If a discovery represents a threat to obsolete technology being sold by the coercive monopolists, the discovery is concealed, and the public never uses it. In many cases, inventors who protest, or refuse to give up their inventions, are fraudulently labeled as "criminals" or "con-artists", by the government, which often adapts abusive prosecutions under the Federal Securities Exchange Commission regulations, or the I.R.S., etc., for the purpose of eradicating competition to their corporate partners.

The greatest threat to the freedom of the people, is official government secrecy, particularly concerning energy and transportation, and coercive, obsolete technological (economic) slavery, enforced by a fascist judiciary which takes its marching orders from the N.S.A., CIA, Trilateral Commission, and the Illuminati (which in our context, involves the upper echelons of the "Knights Templars", and the Jesuit Order—including some within the American Masonic Order...a small, powerful sect some of whom may be found within the Shriners, the Knights of Columbus, the Knights of Malta, the Bilderburgers, or any other secret group, such as the CIA. Some American Masonic lodges have been converted to the Illuminati Order, through the influence of the "Old Prussian, Northern European, White Freemasonry" which was infested by the Nazi "Ahnenerbe". These same powers exist within the Jesuit Order, especially those derived from French and Bavarian sources, after the time of Napoleon. Either way, they get us coming and going.

The greatest threat to the central banks and their underlings—which control basic mineral resources, refineries, chemicals, pharmaceuticals, and public utilities, and other public service cartels fueled by these—is the development of autonomous home-generated power systems, which can power cheap transportation and home industry, and heat and power homes. To make this threat more complete, such power systems should generate their energy from water (hydrogen and oxygen), from the air (combustion of nitrogen and oxygen by electrical spark-discharge), from the earth-atmosphere electrical potential, from cosmic radiation, from magnetism, from non-radioactive nuclear reactors, or from wind and solar power, which the government cannot justify the regulation of because they are safe. The development and use of such systems is completely consistent to the achievement of a pollution-free environment.

The courts insure the cartels against such threats, by secret national security judicial proceedings, binding all judges and courts against all free individuals, under the unconstitutional laws involved.

Corporate-state power rests on control of primary resources, insured by judicial suppression of threatening technology, thus artificially maintaining our dependency. At the top, they are well aware of the existence of numerous inventions which will destroy them, such as the flying saucer, through cooperation with the P.T.O. and N.S.A. Several such inventions have been invented by me, or are represented by my own versions of

what I suspect are suppressed prior art, although they may have in fact been my own discoveries. Sometimes you can never know for sure, because of the secrecy and suppression. On occasion, government scientists with top-secret clearances approached me to deny the government's possession of what they believed I was working on, presumably to induce me to disclose a particular discovery to them in a patent application, so they could acquire it through national security priorities. Since I have already been suckered in several times, I won't do it again, and advise all other inventors to do the same. Unless you're a huge corporation, they'll rip all energy inventions off.

The national security confiscation of inventions creates a convenient shield, so that no patents are granted. The discoveries remain secret, never become public domain, and even the inventors are denied access to them. The government chooses who manufactures them, without the knowledge or permission of the inventors. The inventors are denied knowledge of income and value in the secret usage, and the huge potential profits possible by otherwise public usage, as well as the related benefits of prestige, recognition, and fame. The inventions are appropriated by force, and the inventors given whatever the government decides, if anything. The inventors are threatened with criminal sanctions for disobedience, under national security laws, without the right to public trial. We never benefit, science and the useful arts are not advanced, the constitutional provisions are unenforced or destroyed, and our government has betrayed us. The individual's most private intellectual rights and property—his mind and its creations—has been raped by the fraud and force of his own government. In many cases, inventions are stolen by the CIA, which then creates its own fake corporations to secretly sell the stolen inventions to the government, producing more income for "black operations".

The whining and whimpering by corporate statist, about Japanese or Asian competition, is dishonest, undignified, ignorant, and disgusting. American corporations are at fault for their creative incompetence, and their compromise of the principles upon which a creative and competitive free-market society is based. Those who fear a free world should not be taken seriously. It is they who would drag us into another war for their benefit, by playing on old sentiments, to force us to fight and die for their "right" to screw us and not even kiss us.

The argument that the Japanese do not practice free-market economics internally is impertinent for three reasons, which are: (1) That the competition should be between the best products for the best prices, rather than between nationalities; and (2) that since the U.S. is not practicing free-market economics internally either, the corporations are equitably estopped to complain about the Japanese system; and (3) that since the system which promotes and protects the greatest degree of individual creativity and laissez-faire will be the actual "winner", only these parameters and no others should be considered, in the interest of everyone in the world, regardless of nationality. This is also in the interest of the national security. Trying to bilk a bunch of old veterans of the Pacific war into thinking it is in our interest to erect protectionist barriers, is a lie, and will only hurt the Average American, and empower the elite.

No credit is due to the P.T.O. or judiciary, in the demise of socialism or statism, since they are part of that system, and are still supporting it. All credit belongs to creative people—individual freedom fighters everywhere—whom the corporate-state is against. As part of a world socialist system, our corporate-statists enjoy a greater degree of fascist privilege than their foreign colleagues, and are not entitled to gloat unless they

resign. A protest against socialist bureaucratic deadbeats in Romania, Byelorussia, or China, is a protest against them here. The historical clock is ticking away like a time bomb, and they don't know how to diffuse it. Chernobyl was an alarm in the early morning of vast change. It was no wonder that there were no bureaucrats fighting or resisting Big Brother at Tiananmen Square, Concord, the Alamo, or the Little Bighorn; bureaucrats need Big Brother, and Big Brother needs them. Why would bureaucrats want freedom, which would take away their illegitimate jobs and power? Why would bureaucrats, who apparently represent defective human genotypes who are incapable of independent, creative or productive work, want a free system, in which their only remaining means of survival would be as uncreative and incompetent—although more honest—thieves? Why would bureaucrats want completely safe nuclear reactors, which would take away their excuses for regulatory busy-work, and threaten their cozy corporate partnerships?

For obvious reasons (as some may have noticed), our bureaucrats and some large American corporations have been helping Communist bureaucrats in Russia to resist change. That is because, although change is inevitable, they want to insure that those in control in the future represent the interests of the Trilateral Commission, as did their Communist predecessors, and that renegade, truly capitalist people do not end up in control. If true capitalism were to take root in the east, it might even spread to America. More than anything else, bureaucrats fear the insecurities of normal life in a free society, because the security of their guaranteed jobs has crippled their creativity, which is the primary means for the survival and flowering of civilization and the Human Race. They will have to learn to walk all over again.

B. THE SOCIALIST BUREAUCRACY: A CONSPIRACY WITHOUT LEADERS

It has been estimated that out of every five people, three of them must work extra to support the remaining two who are useless government employees or dependents.

The conspiracy between the U.S. Patent and Trademark Office, the N.S.A., the New Mexico Judiciary, and other bureaucratic, corporate-fascist entities, are united in the suppression of competing technologies, and the continual theft of ideas and wealth from inventors, thinkers, independent scientists, artists, writers, designers, etc.,—or their heirs, grantees, vendees, or devisees. These thefts perpetuate the corporate-fascist system, which is without actual leaders, although there are people who pose as purported leaders. How, you may ask, can such a vast organizational structure continue to function without leaders? First of all, they have almost unlimited funds from us to waste in the process. Secondly, the organizational structure is maintained by a common belief in "collective superiority"—a religion of sorts—promulgated by the Illuminati, which means our bureaucracy is careening down the same road as the alleged leadership of the former Soviet Union, their flunkies. If one examines the so-called leadership structure of the Soviet state from its ineptness—now rendered more obvious due to the relative openness ("Glasnost")—it is apparent that there NEVER WAS any leadership, but rather a mass of people who followed what were proffered by the Communist Party leadership as leaders. The Soviet people followed this pseudo-leadership blindly, until it became apparent that there was no control or leadership, when the system was unable to

feed them, and it imploded, as the people realized that all there was, was themselves as individuals, believing the BIG LIE told to them by Marx, Engels, Lenin, Trotsky, and Stalin, all members of the Illuminati. The wall of credibility was broken away by the harsh reality that the gigantic bureaucracy was bleeding the citizenry dry, while living high on the hog, while attempting to sustain the fictitious collectivist juggernaut. It was Immanuel Kant, Georg Hegel, Marx and Lenin who propagated the Illuminati lie...the half-baked idea that "...each idea contains the germ of its own dissolution"—and that contradictions exist in reality. But the untruth of that premise should now be corrected to say that "each FALSE idea contains the germ of its own dissolution".

The germ of dissolution within the false premise of both the communist and corporate-state Illuminati philosophies, is that each fails to recognize the fact that man qua man's primary means of survival is the creative process, and that an ideal society is one which maintains the conditions under which individuality—required for this human, individual process—is maximized. A society in which the "means of production" (i.e., incorrectly thought by the communists to mean all property, but which in reality is the

individual) is in the hands of an imaginary, leaderless, collectivist state, ruled by a fictitious "mass, collective unconsciousness or consciousness", is the diametric opposite of one which will foster maximum development of the individual creativity of its citizens.

The single greatest enemy of the creative process is dependency (created by fear and a desire for unearned security) which is the hallmark of any socialist state. Creativity, above all, demands the greatest degree of individual social, intellectual, and economic courage and independence from the shackles of any group. The Florentine Renaissance saw a rebirth of creativity and wealth, because of a rediscovery and emergence of the concept of individual rights, which liberated Europe from the shackles of Byzantine Christianity (comparable to today's "religious right") which fathered the Dark Ages. Where people were burned at the stake or impaled if they uttered anything deviating from the 'divine plan', individualism and creativity were practiced only in secrecy, in a society of shared poverty. A long struggle by humanists eventually brought change, and we are still in the Renaissance, continuously struggling to maintain it, while various Illuminati mystics have sought to bring it to an end, and to usher in a Neo-Dark Age, with them as the secret elite.

There is a great difference between the "THIEVES of Light and Knowledge", and the true "BRINGERS of Light and Knowledge". The deluded mystical Illuminati Trilateralists falsely depict themselves as the "bringers of light and knowledge", while other mystics (Christians, Jews, etc., unwittingly controlled by the Illuminati) openly make war against knowledge, as evil, based on their ignorant misconception that knowledge is the product of "Lucifer". This variation creates a false contrast which makes the Illuminati look better. Meanwhile, the Illuminati confiscates the most valuable knowledge, required for them to control the world, gladly assisted by the conspiracy of insane bureaucrats, secret agents of the state, and the "religious right", on their behalf.

The power-mad Trilateralists-Fascists sustain their power by theft, suppression and concealment of the most valuable technology and knowledge from the people, through the national security machinery of the state, in pursuit of the dual goal of state ownership of the purported means of production, and deprivation of the peoples' means for achieving or maintaining freedom and democracy. They are attempting to return us to a dark age of mystical insanity, to worship the concepts of "collective consciousness"

and "cooperation", as "gods", with the essential creative people as slaves, in a "New World Order" (actually an "Old World Order") created and run by them. The religious right is only a temporary pawn in the game. Naziism was their last attempt in this direction, but failed, because their leader, Hitler, like Napoleon, got out of hand, and bit off more than he could chew, just like the Soviet Communist leaders. How many chances does the Illuminati get? Their "Kali Ma" is insatiable, because more people, whom the Illuminati fear, are being born each day, while many are killed each day in fake wars.

The dissemination of knowledge which represents a threat to the secret dictatorship of the Trilateral corporate-state coercive monopolists, is no different than the Florentine humanists defying the fanatic psychopathic criminals who ran the Byzantine Empire. The insanity of those Holy Roman Emperors was exposed by Plotinus, in his Secret History of the Byzantine Emperors, detailing how the Empress Theodora (an ex-whore and dancer from the Circo Massimo) horribly roasted her own child to death in a bronze ox. Her mate, the "Holy Roman Emperor" Justinian, drove 40,000 Mithraists into a hippodrome in Asia Minor, and exterminated them.²

The Trilateral Commissioners, like other bureaucrats and professional thieves, produce no wealth, goods, or services, and for all practical purposes, are "on welfare". Yet these welfare bums use our money and resources to pay for the army of bureaucrats which serve the corporate-state, and not us, with their boots on our heads. All hail, Kali Ma!

Psychologically, socialist bureaucrats by nature are uncreative people who are instinctively intolerant of creative people, who constantly remind them of their own creative incompetence and socio-economic parasitism. It is as if certain defective humans are born to serve the Illuminati. A belief in bureaucratic-socialism is a thin veil covering one's own feelings of self-hatred, fear, and creative insecurity. In America, the existence of this velvet dictatorship is not felt through the iron fist of a Gestapo (short for Geheimnistadtpolizei, meaning "secret state police"), but rather through an invisible, deceptively diffused, choking web of bureaucratic regulatory entanglements and litigation, backed by police who go into action only when social ostracism, subterfuge and intimidation fail to obtain compliance, to use physical brutality to execute court or other bureaucratic orders. Though the people are aware of the problems, they are unable to specifically identify them, since the public media controlled by the Trilateral Commission continuously obliterates and confuses the facts.

There is no genuine support for bureaucracy by rational citizens. Only insecure, deluded, or power-mad bureaucrats take pride in such work, and only stupid or gullible citizens believe that these bureaucrats act in their best interest. In spite of the tintinnabulations of a vast army of yapping attorneys and bureaucrats of every guise, representing Trilateral interests, the people innately know the horrible truth, and it has made them weary, and it despairs them to know that they are not truly free.

It is not a thankless task they do, as some self-deluded bureaucrats may pretend; it is a "useless" task which throws monkey wrenches in everyone's cogs. Anyone with ethics would either commit suicide out of remorse or loss of self esteem, or dismantle their agencies, resign, and never seek power again. How they resist the temptation for self-destruction, in the face of such massive public disdain, is an enigma. In the end, they will be martyrs to stupidity and injustice.

²Otto Benesch, Art of the Northern Renaissance.

There is no accounting of the full extent of the vast waste created by the bureaucracy. Intelligent people will desert the bureaucracy, and find places in the private sector of society. It is all simply a matter of using one's creativity to produce and survive, in a life one can enjoy and take pride in. This simple goal has been artificially made to seem more difficult by the chaos created by the Illuminati, mostly through those in public disservice.

C. TRAITOR JUDICIARY

Members of the American judiciary and bar associations have betrayed a sacred trust and duty to enforce our Bill of Rights, and are hated by the people for breaching that duty. A seemingly impenetrable wall has been gradually built up by the massive volume of past legal decisions and precedents, creating a barrier between the judiciary, and the people who are entitled to demand its sendees. There is massive disrespect for the judiciary and legal profession, which is responsible for a great deal of the crime committed by helpless people, who see no other way out of their problems—created mostly by the government—since the)' lack access to the system.

This one segment of our government is singly responsible for greater damage to us than all the other dangerous subversive and other traitorous elements in our history. They have intentionally misinterpreted our Bill of Rights and Constitution, pretending to misunderstand the concept of natural rights upon which our civilization is based. The general public disdains all lawyers and judiciary because of this, even though many of them as individuals do not have an articulate understanding of their rights. Many Americans who have the most profound ('practical' rather than theoretical) understanding of their natural rights, are among those we generally refer to as the "common, ordinary, working people of America".

The failure by our judiciary to protest, stop, or reverse the erosion and destruction by government of constitutionally guaranteed protections of our inalienable rights, gives aid and comfort to the enemies of democracy (and the enemies are among us), and this negligence is recognized by the people as treasonous. The only response to a more flagrant public hatred of lawyers, for example, was a widespread program of false propaganda which the bar associations unleashed on the American public in 1992, as if the only problem was one which could be cured by false propaganda, when the fact is, our judiciary panders only to those whose vested interests give them a stake in corporate socialism, because the newspaper and other media giants of the Illuminati control the political process through which they are elected. If they do not obey their bosses, replacements will promptly be found. For that reason, corrupt politicians are more persistent than honest ones, which are few and very far between.

A government which abuses the rights of the individual—any individual—because of his individuality, or his conflict with a voting consensus—will get no genuine respect in return. What may be misinterpreted as "respect", is only fear. I think it was either Henry David Thoreau or Walt Whitman who said something like, "When the rights of the many shall take away the rights of the one, the rights of the many shall suffer". It naturally follows that when the 'rights of the many' suffer, the power and jobs of those responsible should be abolished by the 'many'.

The New Mexico judiciary often writes its civil opinions in a psychological lock-step which unerringly elevates procedural bureaucratic rules over just results, because a computer can do that for them. What else should one expect in a red-necked backwash? Their 'judicial software'—designed by the corporate-state judiciary—gives them the most bureaucratic answers, and relieves them of the responsibility to think, sustaining the most extreme positions their supposed discretion allows, continually increasing government power. Only judicial incompetents take such opinions—so lacking in merit, and corrupted by compromise—seriously. The gross lack of cognitive skills—in decisions produced in 'canned English', on legal word processors—exemplifies what I call the "new judicratic callousness". This cognitive incompetence, which began to emerge particularly in the '60s, has finally oozed all the way to the top of the judicial garbage pail, as if the weight of so much fresh garbage has forced the most putrefied, liquefied slime to the top.

Teams of clerks, 'paralegals', and secretaries with word processors, mechanistically dish up superficially formal, substantively deficient opinions which are replete with juvenile smart-ass-type retorts—the only 'original' remarks in the opinions—to the protests of their victims. A computer can have no greater knowledge than its programmer or user, cannot replace human consciousness, and cannot truly conceal the lack of cognitive skills of a judge. We can do without the entire civil judicial system as it now stands. The lack of reasoning skills has finally percolated clear to the top, because the Illuminati wants it that way. They don't want judges who think, but judges who obey.

When something does more harm than it does good, you simply don't have it anymore. There is no inalienable right to file a civil suit, and no constitutional mandate to have a civil judicial system. The Constitution merely states the limitations of such a system, and since these have all been destroyed by the present Illuminati system anyway, let's end it, and avoid future headaches, expense and injustice.

GAME NO. 1: THE NINTH AMENDMENT QUIET GAME

Like pleadings in a court, a patent application discloses one's creative product. I wanted to plumb depth and intent...to confirm or deny my suspicion that I was being forced to deal with devious and evasive bureaucrats, out to help the Illuminati steal from us private 'suckers', with the help of a phalanx of those pompous corporate pederast-whores we call "corporate lawyers", backed by beady-eyed, obedient, fascist. Dobermann-Pinscher-type political cops.

The State of New Mexico and its judiciary, for example, perceives its vested interests as being tied to the history of nuclear weapons development and the nuclear energy industry, as well as the petroleum and coal industries. It is also tied to the tradition of a perennial carpet-bagger "Santa Fe Ring" syndrome, payoffs and bribery, public works money scams, and bullshit politicians, all so easily manipulated by the corporate-state bag-men, the N.S.A., C.I.A., or F.B.I. The system involves uranium open-pit or strip-mines, numerous 'star wars' projects, top secret bases and 'experiments', secret gestapos, weapons tests, and countless security measures and employees. All these magnify the opportunities, to manipulate the judiciary under clandestine "national security laws". It also involves vast amounts of 'federal' (i.e.

'our') funds, as a reward to the "state" (bureaucracy), for following Illuminati orders. Befehl ist Befehl! Very few private citizens question the concept that the New Mexico judiciary has been 'punked out' by the Feds.

They finally pushed me over the edge. This book was a "landmark" decision, unlike those of judges who grovel in obedience to the government and its corporate masters. It is a significant departure which directly challenged the arrogance of power, and advocates a course of action by creative individuals, to bring about an eventual reversal of events against the corporate-state and a corrupt judiciary. It is a kind of 'technological Ghandiism', advocating a passive resistance by creative people, to the "consensus-fascist" system which utilizes deceit, secrecy, subterfuge, character assassination, and the manipulation of the judiciary and public opinion, to fabricate stare decisis and a consensus, used to support its own actions and rulings, usurping and concentrating more illegitimate power each day. Such a fraudulent system is a threat to the survival of a truly free and creative civilization, which we have never fully attained, but can still possibly do so. We must keep our hopes alive, and cannot reserve our challenges until after the present system has already erected a system of gulags, in a role reversal to the policies of Stalin, Hitler, or Mao.

I long since came to the conclusion that there is no one out there responsible for "justice", so I intend to mete some out myself, or at least to incite some inquiry which can lead to justice. The exclamation will undoubtedly be heard: "Well, who does this guy think he is anyway? We'll just tighten the screws on him, and shut him up for good."

The answer is: I am an individual, independent, creative citizen, who is completely proud of what he is and what he advocates, with a completely clear conscience in respect to his motives and actions, despite the derogatory rulings of petty bureaucrats, none of whom can ever say the same. I only regret allowing myself to become a victim of the judiciary and its bosses. As they say in the law, "Where there's a wrong, there's a remedy." It remains to be seen that the 'remedy' is not in the law, but elsewhere. This book may be considered as my "96 Theses", nailed to the government's door (ala Martin Luther's 96 theses nailed to the door of the cathedral), in a new kind of "reformation", involving a new international philosophical movement of creative, autonomous individuals. I believe I represent the future in this endeavor.

A SYSTEM IN CONTEMPT OF OUR RIGHTS

Though my views on the legal profession may seem harsh to lawyers, I will say to them that the only hope for obtaining the future respect for their profession is by restoring the highest values within the legal profession, for the Bill of Rights, as absolute rights, which is precisely what the constitution says they are. Deal with it.

Since the litigation against me was incessant for over seventeen years, the judicial harassment, along with harassment of any kind encouraged from anyone else, amounted to a permanent denial of my rights to free speech and press. Since the public deserves to know the truth, it was imperative that no more time was wasted, and I published my first edition.

Those in the judiciary probably won't like what I am saying, and would probably like to put me in jail to shut me up, although it has been their usual method to use more

indirect tactics, such as citing me for contempt and fining me in the district courts to intimidate and impoverish me or silence my criticism, by constant vexatious orders, including some which not only struck pleadings, but physically removed them from the record to prevent me from further documenting their abuses. Their intent was clear, and my book has proved their assumptions wrong. The connections between attorneys, judges, and the CIA is well-known to some, and while I could point out specific people, it should suffice just to say that the CIA people are there, illegally, all over "city hall".

Let there be no secret; while I respect what the bench is supposed to represent, I see almost no one on the bench who meets up to acceptable standards. As my rights (nature) permits, I have a personal contempt for gutless judges, because the bench deserves better, if it is to exist at all. I actually believe that more acceptable people might be found, despite what everyone says, though I could be wrong. Judges should be completely objective, fair, unbiased, and with unswerving adherence to the Bill of Rights, without regard to the race, religion, ideology, credo, or 'accident of national origin' of litigants—both plaintiffs and defendants, even "Texans"—or witnesses. We should settle for nothing less. This selection should be made strictly by testing procedures which are adopted by Congress. Only those who score the highest should be our judges. This "objective system" would result in more representation by minorities anyway, because those who have been abused should be more inclined to take the Bill of Rights seriously, anyway, and should score higher on the tests. The highest standards for the judiciary are imperative. Though the ideal will always be diminished by practice, we must start at the highest level.

My personal contempt is for gutless, simpering weaklings, who appease sociopathic thug civil attorneys, and the criminal plaintiffs they represent, by allowing them to bend them like pretzels, to obtain fraudulent judgments and orders, and who lack the strength of character to do what is right, and yield to undue influences and pressures, to do what is wrong. I have contempt for those who have unjustifiably shown contempt for me, my rights, and the rights of all individuals, by implication. I have contempt for those who betray their sacred duty to preserve and protect the inalienable rights of the people. Even 'second best' is unacceptable.

It takes no courage by a judge or a court, to maliciously attack the rights of a single pro se individual, or to characterize him as "litigious", because he seeks justice in protection of his rights, and restitution for wrongs done to him and his entire family. Such decisions are no more than cowardly repetitions of the acts of thugs whom the courts have a duty to sanction. In this way, the courts have damaged the rights of all individuals, by attacking the rights of one individual, and by joining with the gangsters and pandering to the worst elements in society. It places our courts right in bed with the criminals and other socialist free-loaders, including rich corporate ones, which makes it a form of prostitution.

Decisions by the judiciary which are unconstitutional for violation of our Bill of Rights, are void, for lack of jurisdiction or of legitimately delegated (or "delegatable") authority from us (as the "consenting governed"), to render them. Such decisions deserve no respect, even if they are 'unreversed' ones, and are grounds for impeachment, because they represent more than mere opinion, but constitute official acts which consciously ignore or destroy particular constitutional inalienable rights of the people without any legitimate authority, as definitive "high crimes and misdemeanors" which are attempted to be passed off on us as "law". Until we have a congress which is capable

of identifying such acts and investigating and prosecuting the same, we will never restore our American Republic.

Perhaps it is obvious that I am not being "nice". I am not in the mood for "nice". The time for "nice" is past. To put it more bluntly, there is nothing in my copy of the Constitution which says I have to be nice to blood-sucking parasites whom I hate, because they have violated my inalienable rights, my life's work, my property rights, and savaged my family. I am not asking them, who owe me, for anything, since it is the resources of victims like me which feed their parasitic lifestyles. The actions of the P.T.O. and the judiciary show that they are completely devoid of the spirit of the American system, or concern for human rights, as envisioned by the genius of Thomas Jefferson and Benjamin Franklin, both inventors. It was no coincidence that they and all the other signators of the Declaration of Independence died as paupers. In their day, the corporate-state system—called "mercantilism"—gave rise to the American Revolution. That revolution is betrayed multiply by the P.T.O., the judiciary, Congress, and the bureaucracy, who do not deserve "nice". They deserve revolution.

The government has perverted our Charter of Liberty and made it into a tawdry wall decoration—a relic of the past—in pursuit of rigid, socialistic, bureaucratic convenience and "order", truly in sycophancy to coercive monopolists (A.K.A., "mercantilists"), who are favored as their natural partners, in a collective ownership system, in which the government gets the power, the cartels get the money, and we producers of all the wealth, are naturally the slaves. Public dissent has been perverted to illegal demands by a minority whose beliefs happen to mesh with corporate-statism, induced by the government to make their demands upon the judiciary and government, seeking to enforce their personal beliefs upon us, and to punish disobedience as a crime. This threat to return to a corporate-state socialist neo-dark age must be stopped. These symptoms of the disintegration of our great society are caused by the misfeasance and malfeasance of the judiciary, bureaucracy, and government of, by, and for itself.

GAME NO. 2: THE ARTICLE ONE (Sec. 8, cl [8])
AND FIFTH AND FOURTEENTH AMENDMENTS
PROPERTY GAME

I have something in store for the "creativity thieves". "Really!" (they exclaim). I have done this before, and I know its works.

In anticipation of the present state of affairs, I took care to see that I had another, superior product "waiting in the wings" as it were, invented long before my birth by someone else, used in a new way, to obsolesce my invention, as my insurance from the anticipated theft. A creative inventor should always be able to "out-create" common idea thieves. While this may be untrue for many of the poor little inventors whose less prolific discoveries have real merit, yet are stolen nonetheless, leaving them without a remedy, because they have no funds for attorneys, this is not completely the case with myself. Though I may lack the large sums required for attorneys—as pointed out by the crappy little patent examiner, though no interference had been declared—I am not a poor little inventor with only one idea; I have hundreds of them, and more to come, at my own discretion, on demand. I am rich in ideas, and rich in the ability to have them. They can take away one, and I'll produce two more to replace it. Then I'll see to it that foreign

competitors receive the two new ones, just to punish the thieves in America. All I have to do is describe them. Foreign industrial spies are everywhere. They scoop up every American suggestion as it is uttered, and proceed like ants to convert them to reality. I must warn the coercivists, that their days are numbered by the lag in progress their suppression has created. The tigers are at the gates, and who will make them respect natural rights, even yours, after you have set the example of abuse and neglect?

Since I am not rich and powerful (in terms of money and influence), the only recourse I now have is to exercise my right to determine the disposition of my more valuable, undisclosed inventions. They are mostly very simple, but highly unusual. For example, in comparison to the invention for which I sought a patent, they greatly depart from the relative degree of novelty. Consequently, I will not share my other inventions with the P.T.O., or with the sick government which employs it, and it will never control what else I have in my bag of creations. In this way, it has betrayed and caused the constitutionally ordained patent system to fail. I will also urge other inventors to refuse to play its game. It is the government which has, in fact, abandoned a legitimate patent system. People cannot be forced to invent, as shown by the example of the recently fallen communist states. Now perhaps creativity and freedom will evolve.

Like the New Mexico judiciary, the P.T.O. exaggerated bureaucratic technicalities, in order to circumvent the obvious merit involved, and attempted to treat everything as if it represented "nothing". This was to protect the corporate thieves from the "doctrine of anticipation", in their patent application, similar to the courts' treatments in the case of the real estate and tort claims, to avoid the doctrine of res judicata. I expected both of these frauds, and was proven correct by the courts and P.T.O.

The implication can now be constructively drawn from the rulings that I am just a "frivolous type of person", and that my other inventions—which I may transfer to foreigners—do not represent a loss of any valuable technology from this country, in the P.T.O.'s view, in which it deferred to the false validity of the New Mexico litigation. We can be confident in the 'correctness' of their rulings, since my credibility was systematically impugned, and there should be no cause for worry, and they should relax, since nothing I said had any merit, in their opinion. I had intended to use the profits—under the remote possibility that my anticipations of corporate/government fraud turned out to be unwarranted—to finance further disclosures and patent applications on my other inventions, for the mutual benefit of myself, American industry, and the advancement of science. The P.T.O. and New Mexico judiciary stopped this meaningless process. Bravo, bureaucracy! The P.T.O. need not inquire into whether or not it delayed or obstructed scientific or technological progress, or abatement of the environmental/energy crisis, since none of my inventions could have helped to bring this about. It is the government, and it is never wrong.

ENERGY SLAVERY AND INVENTION THEFT

I decided in late April, 1991, that if I can't have what is rightfully mine, I will not share my other inventions with the American government, and will file no more disclosures or applications. I conceived the particular invention in 1967. It is admittedly 'low tech' in comparison with my many other inventions, which range over several fields, and include new means of nautical, aeronautical, and automotive propulsion,

numerous energy and power generators, new aircrafts and aerodynamic applications, boats, engines, electric motors, wind, solar, magnetic, super-conductor, and laser applications, semiconductors, manufacturing processes, chemical and metallurgical discoveries and processes, as well as numerous types of "safe" nuclear electric power generators, all but one of which uses no radioactive materials whatsoever. They eliminate the need for a nuclear regulatory commission, or "W.I.P.P.", as well as all the monumental expense, "busy-work" jobs for bureaucrats, and other associated waste, problems, and expense to taxpayers and productive people. In general, my inventions are to liberate people from corporate energy and political slavery. In reality, no ethical person has anything to lose by the widespread use of such inventions. This entire freight train of ideas was derailed and abandoned by the P.T.O. and the National Security Agency (of the Trilateral Commission). When Nikola Tesla took almost the same approach as I have, the F.B.I., with the aid of a specially trained German S.S. nurse, tortured him to death, learned the location of all his secret files, and impounded them under the "Alien Properties Act", even though he was an American citizen. Those

secrets ended up in the hands of the Nazis, thanks to our F.B.I. That was in 1943. The Nazis traded the materials to the Rockefellers and the U.S. government, during a 1945 stalemate, and a large part of them are now stored in Los Alamos, New Mexico.

New Mexico could have built itself a new 'clean' industry future around my discoveries, but its officials viciously kicked me in the teeth. This shows how ignorant people can be led to cut off their noses to spite their faces. Some of you readers may be familiar with "...the Bear, the Bison, and the Muskrat..." (the code names for the top

"Soviet" bombers in 1957—designed by an American, rejected by Congress, and, as we should not be surprised—sold by him to the Russians).

New Mexico won't make a dime off me now, or create a single job, and can continue its self-made bondage to government jobs and the large corporations, for judicially abusing me and damaging my credibility. For this they get nothing! Blinded by petty jealousy, they couldn't see that they were being "motivated" at their own level by the CIA. The issue is not what "this Texan" gets or doesn't get, but rather who gets what I still have, and it won't be them. For slumbering lethargically away on their rights, people must buy foreign-made goods which are superior to American goods, all because they failed to control the corporate state.

For example, in 1980, I conducted what is now called "cold fusion" research. I obtained pronounced heat results using several methods, one of which requires no input energy once the reaction is initiated. I do not describe it as "fusion". The process—now well-known, because later explored in Utah—was not good enough in comparison to better ways I developed, so I abandoned it. I then intentionally leaked the process—with the addition of some ingenious misinformation—to one whom I suspected to be a spy, because I had already been ripped off several times, and wanted the personal satisfaction of watching the thieves turn slowly in the wind of ridicule, as they choked on their own snot.

In the form I leaked it, the process is a very inefficient use of the true principles involved. It will, when properly designed and constructed, produce a continuous, external current of 50 KW, almost indefinitely, using a non-consumed, cheap, easily obtained, 1-mole fuel sample. The Utah experiments yielded relatively smaller net gains in energy, because the scientists were attempting to proceed according to accepted methods. I watched them beat their brains out unsuccessfully trying to explain it, with

pleasure. Of course, there are readers who will disbelieve me, refusing to concede that an amateur scientist could explain what the experts have failed to explain. The answer can be found in my book, *Occult Ether Physics*. As it turned out, the spy, who is still a friend of mine, was working with some Mormons who were unconnected to the Trilateralist rats who had ripped me off before. He was sincerely doing what he thought to be the right thing, by taking the information to people who at least had the guts to try. No mon, no fun, I won. Poetic justice. They shouldn't have stolen my secrets, and denied credit where it was due. The spy is to be credited however, for properly interpreting the obvious undermining of my credibility by the state/Trilateralists, all the way back in 1980, as proof of the value of my inventions, and for placing the discovery into the public domain in the most spectacular way, which I believe was their intent. They sought my secrets after a very powerful New Mexican had benefitted from a 1979 theft of one of my inventions, which worked very well. That beneficiary will eventually suffer a loss as a result of my present actions, and the "domino effect" applies to aligned interests.

Another good example: My cousin (a mathematical and electrical and computer engineering design genius), was pursuing an electrical engineering degree, and was forced by circumstances to drop out of college in 1957, taking an approximately \$2.00 per hour job with Texas Instruments, in Dallas. Within a few months—when he was nineteen—six full-fledged engineers were required to execute his designs. In 1957, he showed me his original circuit design for the integrated circuit, drawn on a small scratch pad. For this discovery, Texas Instruments gave him a \$100.00 bonus. This circuitry was incorporated into America's first satellite, and was a great "miniaturization" breakthrough. Credit was shared among two of six engineers who worked under Mark, building the things he designed.

In 1970, T.I. fired him, because he had no Ph.D.; he received no credit, and only a pathetic wage for his billion-dollar discoveries. T.I. also later marketed his personal, hand-built computer, which he left in his office when he moved out of it, as their "Table Top Computer". He received nothing for that either, and did not fight for his rights, although he now works for a company he created, designing perhaps the world's best medical computers, which are used by the foremost medical facilities, including the Mayo Clinic, the Einstein Institute, and the San Francisco Medical Center. He should be at least a multi-millionaire, but because he is a pre-occupied, somewhat reticent, creative genius, his rightful millions went to common thieves. So much for Mark Daniel Broussard, genius.

The first major invention I lost, was one I invented in 1948, at age ten. My own father gave it to the patent thief. The thief filed his application for patent in 1950, just after my twelfth birthday. This invention is everywhere. The second major invention loss was attributable to my own negligence, by allowing a friend to use it on his competition drag-racer, built in the shop of Jim Hall, the well known car builder/racer, in Midland, Texas, in 1967. It was appropriated by Hall and ended up at G.M., and was initially used on the Hall-built Ford Chaparral, Grande Prix, CanAm, and Indy cars driven by the Unser family of Albuquerque, where Jim Hall is from. The discovery is used throughout the high performance automotive and racing field today, and has even appeared on mam high-end sports cars. I discovered and tested the first automotive "ground-effects" system, when I was fourteen years old, in 1952.

Such situations as these are commonplace. The few stories the public hears about, involve inventors who survive the onslaught of corporate intrigue and power, and find competent legal representation. From creativity studies³, it is known that creative geniuses are often neurotic to the point of being semi-disabled, as a direct result of their creative abilities, and vice-versa (that certain disabilities and illnesses are often related to a higher creativity)⁴. In fact, a "neurotic phase" in the creative cycle, is generally recognized. This phase usually precedes the "productive phase". In such phases, the consciousness is often altered to increase the probability for a "bisociation of two or more previously unrelated matrices, on the pre-conscious level"⁵. The phases are often intentionally self-induced by creative individuals, as the price they must pay for their creative productivity. While we all benefit from this phenomenon, the inherent naivete or disabilities of inventors makes them vulnerable to con-artists, the government, doctors, lawyers, and corporate thieves. Where such individuals are looted from and denied reward, they may afterward pursue generally four courses of action, which are: (1) To continue in a more or less permanent state of neurosis, in which they no longer produce; or (2) continuing as usual, masochistically getting their teeth repeatedly kicked out; or (3) becoming 'normal', and never creating again; or (4) continuing to use their creative process to obtain revenge and to change the system. (I have opted for this last alternative, and advocate that other creative people do the same.)

It is in the interest of everyone to see that our creative geniuses receive just rewards for the work they do. Failure to do so will leave our problems unsolved. If society punishes them, it is punishing itself.

TRIUMVIRATE OF INJUSTICE

The P.T.O. is the "Vacuum Cleaner of Creative Minds" for the cartels. The judiciary is the "Extinguisher of Competing Claims" for the cartels. The lawyers are the "Hit Men of Problem People" for the cartels. The cumulative effects of this triumvirate of injustice, is to enslave humanity, and to bog it down in its problems, with the cartels posing as the "saviors apparent", by dosing out whatever stolen "solutions" it chooses, at the most opportune moments of prolonged agony—usually created by them—calculated to extract the greatest degree of continued dependency. This cycle can be broken and rectified only by restoring justice for those who will provide the solutions. Ironically, the P.T.O. may find itself unknowingly registering some of my inventions in the future, under international patent treaties, but may never know which ones were mine. They've already issued several patents on some of my inventions anyway, stolen by their friends. My 100 or so other inventions will still benefit mankind, with the exception that American corporate thieves and others will be eliminated from the major action, by those of my choosing, who will receive the benefits in the particular fields of application. Not only will the American corporate thieves be deprived of the opportunity

³Creativity and Learning (an anthology edited by Jerome Kagan, the Beacon Press, Boston, 1967).

⁴Dr. Edgar Mayer, Genius and Prolonged Illness, WISDOM MAGAZINE, Vol. 3, No. 25, May 1958.

⁵Jerome Kagan (supra).

for theft, but will be deprived of profits, and will be punished by their foreign competitors. Didn't they 'trade with the enemy' during WWII? Turn abouts fair play.

The only track record I have in patents is for being ripped off. I hold no patents, so, at my option, it is only a matter of determining who gets to rip me off, by giving the edge to competitors of the 'domestic rats', rather than to allow them to rip me off, through the P.T.O. or other con-artists. The thieves who have profited from my prior inventions will know this is no joke.

For a prolific, yet relatively poor, inventor like myself, there is no protection under the U.S. patent system as it now stands. I have so many good inventions that there is no way for me to proceed with applications and disclosures, because the system is almost too expensive and time-consuming, even to process a single application, much less over a hundred. And the answer is not to provide federal funding for an army of legal creeps in Washington, to process the applications of "poor inventors", because that would only create increased abuse and leakage of patent secrets to the Illuminati. I could be swamped with interference proceedings on a single application, leaving all other applications abandoned on bureaucratic technicalities, such as failure to respond in time, caused by judicial interferences. The P.T.O. has stated its rigid position on such interferences in my first application, and would not consider them, so I will no longer consider them. The P.T.O. therefore, always has the option of throwing the game in favor of the corporations, to unjustly enrich and empower them. The system as it now stands cannot meet the constitutional requirements, is unjust, and like the judiciary, will collapse under the weight of its own self-created bureaucratic flab, duplicity, incompetence, and deadwood.

Where some of my inventions are composed of several novel elements, each of which would support an independent application, requiring conceivably months of work to segregate to the satisfaction of the P.T.O., the problem is further complicated. In the case of one single application, over three years and considerable work and expense have been consumed. The U.S. government in general is to blame for this quandary. I cannot leave my work stored in notebooks, or in my mind, only to have the P.T.O. reject a future application as abandoned, on the basis that I have 'secreted' it away, when in reality, the past shows that I can't secret something away which I never had an adequate opportunity to disclose, or to protect after disclosure. They won't consider such a defense, since I tried it and know. So the P.T.O. has its rules, and I have mine.

I was plagued by Trilateralist/Illuminati invention-thieves, who looked for opportunities to steal other multi-million-dollar discoveries so they could get filthy rich. while I languished away in poverty and legal problems created by them, with my credibility destroyed by the corporate-state fascist judicial yeggs.

Therefore, I will simply see to it that the general public or foreign competitors end up with my inventions one way or the other, and there is nothing the corporate state can do to prevent it. If I am to be ripped off, I appoint the public or foreigners, or both, as beneficiaries, rather than my own government and its fascist corporate partners. I had rather give my discoveries away even to enemies than to see traitors profit from them. In the future, this writing can be referenced in retrospect, to confirm the fact that a warning was given beforehand, stating how the problem developed, and that the government refused to take any action until it was too late.

I now lay the blame at the feet of the P.T.O. and the American Judiciary (particularly in New Mexico), and the manipulatory corporate-fascist U.S. government.

History often shows in retrospect, injustice, stupidity, or wrongdoing. I don't relish being viewed in the future as a tragic loser who was ripped off without a fight, so this testimonial fixes the blame for future problems, enabling the future to judge whether the government was rightfully convicted by me, and whether the ends of true justice were served. Those who put my name in their judgments will now have some of their names placed in mine, in the court of public opinion. Now it is their turn to defend themselves.

GAME NO. 3: THE FIRST AMENDMENT END-RUN GAME
(A.K.A. THE OI' STATUTE OF LIBERTY PLAY)

But these actions (or non-actions) are insufficient to adequately punish the corporations or the U.S. government and its judiciary, or to hold their feet to the fires of creativity, so I have yet a third part to my revenge, which involves the most symbolic of all invention rip-offs. If it previously appeared to be of value to anyone, to deprive me of that one patent, or to deprive me of some small property holdings and rights in rural New Mexico, or to smash my life, that value will eventually be seen as a huge blunder on the part of the P.T.O. and the New Mexico Judiciary, which directly triggered (1) my refusal to make further disclosures to the P.T.O. of my other inventions; (2) my transfer of inventions to foreign competitors; (3) my publishing of my research and inventions; and (4) the publishing of this crazy old book, SPACE ALIENS FROM THE PENTAGON: FLYING SAUCERS ARE MAN-MADE ELECTRICAL MACHINES, © Wm. R. Lyne, 1993, 1995, 1999.

CREDIBILITY ROULETTE

Without actual proof of what I assert, the government will have to be content with the unanswered question of whether or not I really have the inventions and knowledge I claim, and whether their conduct will be worth it in the long run. The government will just have to gamble with my credibility, and take its own risks as to whether my punishment will be real or fantasy. We can play "credibility roulette", with this book (the pistol) pointed at its head (the most valuable secret of the Illuminati).

It is not necessary that my book be taken seriously by the government, since, in response to my legal pleadings, the legal numskulls said that my requests that my constitutional rights be observed, protected and enforced, were all just "fantasy and fiction", and "frivolous". In the government's view, this book should be considered as written with "tongue-in-cheek", and not intended seriously. Meanwhile, you who are individuals (the "reading public") can examine my book, do some research and experiments, and decide for yourselves its value, in spite of the Illuminati's attempts to mold your thoughts beforehand, with over forty years of BIG LIES.

Bureaucrats naturally underestimate the power of the individual, since they are collectivists who lack a concept of individuality. I would have said this much sooner had it not taken me so long to gain the opportunity between harassments. Even though I am aware of the danger to my family and myself, and since there have already been several murder attempts, any one of which could have succeeded, I say this while there is an

opportunity to do so, to remove their motive from the equation. Besides, it is really they who are afraid of the truth.

I have no duty to exclusively share my ideas and discoveries with a degenerate government which maintains illegitimate power by punishing, impoverishing, stealing from and enslaving individual creative people whom the government sanctions as its victims, through perverted laws, awarding the victims' productivity to itself and its corporate thief partners, under the banners of the "public good", "justice", and "national security". Government-backed coercive monopolies are criminal conspiracies, which should be prosecuted, abandoned, denied support by all people, and deprived of the fraudulent and illegitimate use of our government by consent of the governed, as a deceitful and fraudulent means of private coercive control and power.

If American citizens are unable to dismantle this system, by withdrawing consent they never gave in the first place, by deprivation of the legal method to do so, creative people must now create a unity of purpose, to "go on strike", to use the ultimate power of individuals to deprive the system of power, for treasonously militating against the most fundamental human right of all, the right to the freedom and protections which are essential to the exercise of the individual creative process by all, in a creative and abundant civilization, rather than one ruled by the fraud, deceit, extortion and the brute force of coercive monopolists, through bureaucrats they control, who should each have to earn their own bread, rather than to mooch from us.

The thing which has made America great is its Bill of (human) Rights, guaranteed by our Constitution as absolute (inalienable) rights, required to maintain the conditions essential to the free exercise of the creative process, as civilized man qua man's fundamental means of flourishing and survival. Whether called socialism, fascism, communism, bureaucracy, coercive monopoly, or any other name for dictatorship, the rights and conditions essential for creativity are being destroyed. An awareness of these facts are bringing some individual Russians and Chinese to their senses. Humanity is composed only of individuals, who are not "national resources", each of whose right to life is an end in itself. Individuals must engage in a peaceful revolution to overthrow the insanity of collectivism, and to re-establish the human creative rights necessary for humanity's survival and flourishing, in peace, throughout the world.

The judiciary as it now stands is traitorous, lending aid and comfort to the enemies of democracy and our Bill of Rights. Not a single yellow government judicial or legal son-of-a-bitch has stood up on his hind legs and protested this, as a treacherous failure of sacred duty. The 'legal profession' is the single most treasonous conspiracy in America, and is an indispensable part of the corporate-state conspiracy. The damage done to me by the P.T.O. and the New Mexico judiciary, is a symbol of their damage to all. Whether they justify their acts through phony-baloney double-think, judicial decrees or "office actions", I have been provoked into justifiably punishing them through rightful means, for the good of civilization, by exposing them, withholding my future disclosures, and by disposing of my own creative products as I deem fit. in a way predicated to bring the maximum detriment to them and their kind, even at the future expense of millions of dollars lost to myself, which I will never see anyway, because of them. The public must know the truth about how the cartels are oppressing all people by suppressing knowledge, especially flying saucer technology and other secrets relating to energy and transportation.

D: AMERICAN DISSIDENT TRIALS, MURDERS, TRIBULATIONS, AND MASSACRES

Some readers may ask what this chapter has to do with flying saucers. This 'secret' is only one of many. The disease of secrecy threatens to take over everything, until every citizen obtains information only on a "need to know" basis, just as if he were in the CIA. That is the logical conclusion of a totalitarian police state. This book is about how a jungle of LIES has been created, by perverting all the instruments of a purported "democratic" society, for the ostensible purpose of protecting something called "national security", but which, if left unchallenged, will eventually lead to our complete enslavement. At this very moment, I hear the roar of the jet engines of military fighter planes, as they greedily slurp up expensive fuel, when a flying saucer operates on practically nothing. To some deluded people, the roar of the jets is synonymous to "protection" and "freedom", but to me, it is the sound of "waste" and the "draining away of the abundance created by the sweat and blood of the American People". In the words of Patrick Henry, "Is life so dear and peace so sweet, as to be purchased at the price of chains and slavery?"

When life-threatening violence is stirred up against you by the CIA, with law-enforcement personnel instructed to provide no protections, you cannot take matters into your own hands to obtain justice, because that is what they want you to do, and almost anything you do might become an excuse to throw you into jail, where your life can be snuffed out in a minute. Though the things they are doing mark them as the lowest of sociopathic criminals, you must understand that the only way to defeat them is to refuse to make the wrong, impulsive move, so they can't depict you as a "violent", "bad", or "mad" person, and treat you accordingly. You must design effective countermeasures, and carry them out.

I once naively believed that, under the "Anglo-American System of Jurisprudence", only a "real" criminal could be convicted and sent to prison. What a delusion! It came home to me in 1980, that in New Mexico, they can and do frame, convict, and send innocent people to prison, and that this is one of the easiest places in America for them to get away with it. This is nothing new in America, witness the examples of Wilhelm Reich, Sacco and Vanzetti, Leonard Peltier, and a host of others. The only difference is, that the Feds have learned from experience, and do it slicker today, thus confining the knowledge of their criminal behavior to only a few dissidents and perhaps their trusted friends.

A lot of what this book is about is how I managed to avoid a million pitfalls, and survived long enough to tell you these things. To avoid legal entanglements, I intentionally excluded the names of many people, even after an attorney friend in Santa Fe advised me to include the names, on the basis that "the truth" is a "good defense" to a suit for libel. But I didn't hear him guarantee representation in case I was sued because of following his advice.

I am sick of lawsuits. Putting in the names could provide a "wedge" for potential instigators of suits, to further impede my informing you on the corporate-state Illuminati conspiracy. An unwanted libel suit against me, a pro se party, could enjoin my efforts. This book is not intended as local petty gossip, or a local-type expose, to be applied only to the local scene, but is a handbook for analyzing and defining the same methodology at work everywhere. Most of the yeggs are weaklings who have already surrendered their

identities as individuals anyway, so why flatter them by giving them identities they really don't have? And, of what use is a "good defense" to a lawsuit, when there are no honest attorneys to take cases before judges who get their marching orders from the Illuminati? We can turn the tables by denying them the satisfaction of filing suits, to make money for attorneys, or to make them "heroes". We must boycott this fraudulent legal system.

One's attorney can be compromised, intimidated, or just plain "bought off", in several unsuspecting ways. One way is the "referral service", in which they are given another case, providing plenty of income over a longer period of time, with ultimately greater career benefits and prestige. Another way is to accuse them of "Rule 11 violations" (frivolity), threatening to drag their name through the mud of ethics and contempt proceedings, and hit them with fines and sanctions, etc., unless they drop the case and concede victory to the other side. Other ways are to use sex or drug inducements, or plain old physical threats or intimidations. The state tort claims liability act allows state-employed members of the A.G.'s staff to "pay off" your attorney, in settlement of a claim against the state, without you ever knowing about it, dismissing the suit, while your attorney pockets the money. This is just plain old bribery, but they can and do get away with it. Another way is to appoint your attorney to a position such as county attorney of this or that county. Every single one of these tricks were used on attorneys employed by me. Once your eyes are opened to these tricks, the possibilities abound. The bottom line, however, is that most attorneys are yellow, money-grubbing Shylocks, who avoid controversies like the plague, except those they fabricate.

"Sacharov-type dissident trials" in America are similar to those of the former Soviet system, and the Chinese Communist "mass propaganda show-trials". Of the two, the Chinese system is most like ours, prohibiting publicity in suppression cases, to avoid arousing public suspicions in a so-called "democratic society". The victim's rights to freedom of speech and press are often denied without him ever realizing it. In China that hardly becomes an issue. Our system is becoming more "Chinese".

The CIA ingeniously creates "Kafkaesque" judicial harassment which is seemingly unrelated to the object, appearing to be 'random litigation', difficult to connect to its real source. Constantly tampered and stolen evidence, missing, falsified, and incomplete records; constant set-ups, falsely induced situations and trickery; judgment executions, threats to confiscate and sell your personal property, constant, unannounced visits to your home by sheriffs deputies and process servers; perjury and false witnesses, constant false allegations, personal attacks, assaults on credibility and character; induced breakup of one's family; sham trials, false contempt proceedings, compulsory appearances, interruption of work, harassing discovery proceedings and orders, reduction of earning capacity, fines, expenses, grillings over every detail of one's personal life and invasion of privacy; all gradually building a false record against an innocent victim, and a massive computer information file which is readily available to the government criminals perpetuating the judicial terrorism, so that any information which they wish to exploit can be instantly programmed into the next phase of their plans. In America, this can be harsh, because it is covered by the hypocritical illusions of "freedom" and "due process".

Does this sound like America? It is and has been a reality for me, and it has been made to appear to be the result of "property dealings"! In reading this book, you should ask yourself if the kind of person I am, who would devote so much of his time to science, art, creativity, philosophy, and "true justice", would be capable of creating 17 years of

litigation for himself, just so he could remain poor, and be unable to realize anything from his dreams? Why would anyone who had never gotten anything out of any lawsuit, except less than was already his, have any reason to remain involved in court proceedings which in the past have only unjustly deprived him of time, money, energy, property, joy, life, and countless other things? Very few, if any, of the "newsworthy" aspects of this abusive litigation were ever reported in the press, after the initial "Big Bird" publicity, since the guilty parties suppressed publicity in subsequent harassments, knowing further wide publicity could arouse questions of legitimacy among ethical citizens, to possibly rebound in my favor.

It is immaterial as to whether or not a victim discovers the motive or identifies the true instigators, who are able to misuse the power of the state to conceal their crimes, the knowledge or evidence of which could prove a cause of action for violations of 42 USCS secs. 1985 and 1986 (Civil Rights Act). Ha! The victim will be unable to continue the (undesired) conduct, and "suing" is out of the question, because the harassment takes all his time, energy and money. Designed to disturb his mind and autonomous nervous system—like the attacks of S.S. "psychiatrists" in pre-WW II Nazi Germany—the victim's inability to pursue the (undesired) conduct is the object of the litigation. The negative reinforcements are designed to create "conditioned (neuromuscular) responses", like Pavlov's dogs. The process is designed to destroy the victim's individual identity and will power, by invading the privacy of his mind and body, through "object lessons", compelling him to take the desired course of action or non-action, as if he had done so willfully.

After the psychopolitical earmarks of the process became obvious, I became determined to produce this book, once and for all, even if I had to write, illustrate, print, bind, and distribute it myself. As it turned out, I actually did all that in my original edition of 1993, and first reprinting of 1994.

I would like to point out that, the techniques through which the CIA has sought to perfect "mind control", is best demonstrated by experiments in which they actually created "Manchurian candidates", such as John Charles Whitman, who shot over 22 people beneath the tower of the Main Building at the University of Texas, in the summer of 1967. By directing certain psychological harassments and conditionings toward particular unsuspecting subjects who meet psychological profiles revealing their vulnerabilities, they subliminally induce them to follow a certain course of action. Since I was present during the Whitman massacre, and almost got hit by one of his bullets, the situation got my attention. Did you know that as a Marine, Whitman was trained with Lee Harvey Oswald, at the same Marine "assassin school" in Japan? Whitman, from Florida, was also one of those "good Catholic boys" who had made it to Eagle Scout. At the time of the massacre, he was being treated at the U.T. medical center, by the same CIA psychiatrist—a Dr. Smith—who had previously treated Jack Ruby while he was in jail in Dallas, for killing Oswald...until Ruby died of cancer of the knee, thus neatly tidying loose ends, such as the possibility that he might talk. Whitman also had a terminal tumor (in his brain), planted by injection, which he supposedly knew nothing about, but I believe he found out about it. Two murders, two tumors, same psychiatrist, and the same CIA connections and training. As was pointed out by Jim Garrison, former New Orleans D.A., David Feme had engaged in extensive medical research on behalf of the CIA, developing field methods for causing cancer in unsuspecting victims (such as giving them an injection of turpentine). Does this ring any bells?

In order to discover how to defeat the Illuminati and our crooked judiciary, one can refer to a book given to me by the Air Force in 1958, written by Duane Thorin⁶, a former "psychopolitical" victim. Thorin was a Navy warrant officer and helicopter pilot, who based his book on his experiences as a P.O.W. in North Korea in the 1950s. He was also the person who inspired James Michener's *The Bridges at Toko Ri* (which was made into a movie starring William Holden).

The fictional hero/victim in Thorin's book discovered that the psychopolitical "interrogators" used "mood control". After discovering what a victim wanted most of all—such as a simple bar of soap, because the prisoner wanted to bathe—they deprived him of it, thus controlling his moods, intended to psychologically break down and override his conscious resistance, until he gave them what they wanted. The interrogators concentrated their "work" on leaders. This method worked on many, if not most victims, but not on the hero in Thorin's book, who discovered that he could exercise his individual discipline and knowledge to defeat the criminals, either by pretending to want something he did not want, conditioning himself to want nothing, or simply playing a cat-and-mouse guessing game with the criminals.

In my case, they were firmly convinced that real estate was the way to control me. However, "...the wheels of justice turn exceedingly slow, but grind exceedingly fine", and since judicial psychopolitics and abuse are not "justice", the "grinding wheels" of our judicial system are crumbling and running out of time as the system is being squandered on abuse, and is not respected by anyone, even the people who run it. Truth and justice can flow from falsity, but lies and injustice which are artificially made to flow from the truth, will eventually destroy the system, demoralize those who run it, encourage defections, and destroy the liars, by invoking the wrath of the public. Today, the self-esteem of lawyers and judicial professionals, and respect for them by the public, is at an all-time low. The public hates them, and a revolution is at hand.

The CIA motive in my case, was clearly to conceal flying saucer and other alternative technology, and to coerce my compliance to their wishes, by psychologically imprisoning me through judicial abuse, while silencing me with false contempt orders and litigation ad infinitum, concealed from the public by suppression of publicity, lies in the court records, and occasionally lies in the press.

During the most intense six-year period of this litigation, my typical day consisted of my arising at around 4:30 A.M. with pleadings boiling in my mind, to commence drafting the day's pleadings. I would then begin typing them up, while checking legal authority carefully to be sure my points were correct. As the clock moved toward the deadline—I had to complete the typing by 4:00 P.M., eleven and a half hours later—I would be working at a feverish pitch which barely left time to travel to Santa Fe, to reproduce pleadings, to serve them on the opposing side, and to file them with the District Clerk.

As an example of the kind of energy and research the CIA puts into these kinds of activities, I present the following facsimile news clipping from around 1980:

⁶Duane Thorin, *A Ride to Panmunjom*. Henry Regnery Company, 1956.Z

CIA attempted to hide 'mind control' project

The Washington Post
WASHINGTON - The Central Intelligence Agency in the 1950s sought to use Georgetown University Medical Center in Washington to hide "a cover organization for highly sensitive projects" in "biological, chemical and radiological warfare," it was learned Saturday.

Top secret CIA documents made available to The Washington Post disclosed this purpose without mentioning any university's name. They spoke, too, of plans for research in "psychological fields," "natural toxic psychosis" and "what makes people pass from mild disorientation into delirium and coma" - all fields that fit then into the CIA's aim to investigate mind control.

An informed source said these and other documents referring to "research on

terminally ill cancer patients" pertained at least in part to CIA aims at Georgetown University.

The documents provided some of the first specifics on CIA goals at Georgetown since the disclosure last week that in the mid-1950s the CIA channeled funds through the Geschickter Foundation - a foundation directed by a Georgetown professor, Dr. Charles Geschickter - to establish a secret base for sensitive studies.

Dr. Matthew F. McNulty, head of the Georgetown University Medical Center, on Saturday said nearly two weeks of research and interviews have turned up no evidence that any research ever was done on medical center premises on the CIA's behalf or with hidden CIA financing.

But he also conceded that he is still far from completely informed or sure of what

happened there in the 1950s and 1960s.

The evidence, he said, is that the CIA indeed tried to establish a secret mind-control research center at the university.

And he called this "an abuse of an institution's integrity and independence of operation and decision making," and an attempt to distort a place that should "always be overt, not covert."

"They didn't approach us above board or by open declaration," he said. "They apparently utilized foundations and institutions of repute and through them obtained the services of scientists, but never with any disclosure to the institutional leadership responsible for the conscience and ethics of Georgetown and other universities."

Back in 1975, when the CIA job was offered me, the Oil Queen had somehow gotten the idea that I was a "junkie", a misconception she derived from a conversation about "smoking dope" (marijuana), which she thought meant heroin. She then offered a "deal sweetener", saying that, if I accepted the offer, her associate, a (CIA) psychiatric nurse named Pat, who worked in an Albuquerque hospital and lived in the Sandias, would provide me with 'any kind or amount of drugs I wanted', at CIA expense. As I later learned, the CIA had sent this nurse to our O.S.O, meetings in 1966. This kind of CIA hypocrisy has now come to the attention of the American public, and they want it stopped.

Believe it or not, the 'justification' used by the CIA for keeping O.S.O. under surveillance, was because Howard Rourke, the fictional hero in Ayn Rand's novel, *The Fountainhead*, had used dynamite to destroy a building he had designed! By some twist of 'reason', they used a fictional 'incident' from a novel, to construe our philosophical/literary study group as a potential threat to the 'national security'! The sickening truth was, that our very reasonable group (which advocated 100% laissez-faire capitalism, along with the dismantling and abolition of the CIA) unknowingly conducted its weekly philosophical discourses for the ultimate benefit of the CIA spies sent to keep an eye on us. Seeing no mad bombers in our midst, and knowing a good thing when they saw it, they just glommed onto us like parasites, using us as a surrogate 'think tank'. They were as smart as cancers, and just as insidious. They learned to walk like us, talk like us, and think like us, but no matter how hard they try, there is usually something in

their act, such as contradictions between premises and lifestyles, which shows them to be counterfeits. Their behaviour is the best argument I know of, to support the existence of "aliens". The following two clippings show the kinds of "subversive" activities sponsored by O.S.O. in the late '60s, at U.T.:

<p>This ad was purchased by the Organization for Students of Objectivism after the Texan staff's third failure to print the information contained herein.</p> <p>THE AYN RAND PROGRAM</p> <p>Sundays at 10:00 P.M.</p> <p>KUT-FM (90.7 m.c.)</p> <p>Jan. 7: Theatre and Motion Pictures I 14: Theatre and Motion Pictures II 21: The Role of Law 28: The Press I</p> <p>Feb. 4: The Press II 11: Neitzsche-ism 18: Humor 25: The Draft</p> <p>Mar. 2: Romanticism vs. Naturalism 9: Robber Barons 16: Interview with Nathaniel Branden 23: Psychology of Literary Preferences 30: The Student Rebellion</p> <p>Sponsored by the Organization for Students of Objectivism— a university student organization.</p>	<p>ORGANIZATION FOR STUDENTS OF OBJECTIVISM will meet from 7:30 to 9 p.m. Thursday in Business - Economics Building 261. Those attending will hear a recording of a speech by Nathaniel Branden on "An Introduction to Objectivism." The public is invited.</p>
---	--

In 1976, I had began researches in metallurgy—particularly on the platinum group metals, primarily for energy uses—and in 1978, had succeeded in 'dropping' (precipitating in a high-temperature metallic solution) a considerable amount of indium, by a rather simple, cheap, and novel method. I had already lost a great deal of these metals in some accidents along the way, but in 1979, I had a 99.9% pure 80 ounces minimum of iridium, valued at approximately \$80,000.00 at the time. Due to my lack of knowledge, I was unable to identify the metal until Oct. 23, 1979. The only person I told about this, was the Paperclip-connected neighbor, who had gained my confidence. Meanwhile, only his yegg, named "Dave", knew the location of the metal in my home. The metal was in the form of finely divided powder, which only he could have identified, or known the location of.

In early 1979, I had been tricked into another legal involvement, by the yegg, Dave, who had once done an ingenious arson job for the CIA in the Caribbean. He was a former member of the State Police who had been kicked out after running over and killing a child while drunk on duty. He had also worked on a sheet metal crew with my

former father-in-law, at the Brown and Root shipyard in Houston, during WWII. As far as I could determine, they were all closet homosexuals. Dave was not a Mason, but the rest of them were. He was also the only one of the group who had never become a millionaire. Brown and Root apparently had a whole cluster of 4-F closet queen Masons working in their shipyard sheet metal shop, one of whom was from the Brown family itself. The 'defense work' allowed them to avoid the draft. It seemed to me that the connective thread here was a closet homosexuality within the good Ol' boy Masonic network. If this sounds like sexual bigotry, please bear in mind that these guys are not civil libertarians, but coercive monopolist crooks who will kill to conceal their secrets.

The real estate fraud was induced by Dave through a young man—also named "Dave"—who sold his body to some of these closet queens, and who has since been sent to the nut-house several times. As I overheard Dave remark to the young male whore, "First set him up, then knock him down" (referring to me). The male whore was also a student of a Santa Fe (closet bisexual) C.F.R./Illuminati/naturopathic physician, whose Chicago father sold platinum metals to the U.S. government. The neighbor knew I was involved in platinum metals research, and hired Dave to investigate this for him and a group from Chicago, including the naturopath and his father. Many of these Chicago associates were Europeans who were given new identities under Operation Paperclip, following Hitler's 1945 stalemate deal with 'us'.

The operative's approach was to get me to go out to remote mining locations to explore for minerals and stake out claims. As any con artist knows, the 'bait' is a promise of something to the 'mark' (me), which in this case, was the claims. It was contemplated that, while in the process of prospecting, I would eventually disclose the details of my platinum research, source of mineral concentrates, and method of recovery.

The claims which I staked out, however, were not for platinum metals, but for a 97% pure silica sand. In this respect I had developed a new and cheaper mass-production method for the manufacture of solar-voltaic chips, which were also more efficient than previous ones. The details of this research were also disclosed, along with the location of my purified indium, and the preliminary plans which I had prepared on my new solar-voltaic system, based on the sands. Dave was a tall, skinny, over 60, southern redneck hick, who was an unlikely candidate for closet queen or industrial spy. It seems the CIA prefers "closet queens" or other people who seek to hide skeletons in their closets, because of the blackmail potential, as a means of CIA coercive control over operatives.

On June 14, 1979 (my birthday again), Dave came by to go to the claims, but it rained, so he came again on the 15th, to go to the San Pedro Mountains, to do some 'work on the claims'. After considerable walking, we returned to the pickup for a rest and some water. Dave, who was diabetic, drank fruit juice, as I drank water from a large canteen. The water tasted strange and moldy, and I wondered why a diabetic would drink fruit juice rather than water, since it contained sugar. We returned to our work, and I walked across the claim to check a location point, as Dave sat near the truck, nervously clutching my bag, in which I usually carried a pistol, Little did I know, but he was just waiting for me to die. This was only one of several attempted murders, and I have always wondered if an occult principle was involved, since the attempts were often made on or near my birthday.

While walking along near a rock ledge, I suddenly passed out, fell off the ledge onto the top of a large clump of cholla cactii, and literally impaled the lower part of my body

on them. The excruciating pain and rush of adrenaline revived me from my unconsciousness, and I painfully removed myself from the clump, and extracted as many of the spines as I could—some of which pierced to a depth of over an inch—and returned to the truck to pull out many more. While bending over the seat in the truck, I discovered a plastic 'baggie' in the floorboard, containing crushed Angels de Dios (small, white, highly poisonous mushrooms). Their smell was identical to the moldy smell and taste of the water I had drank from the canteen, the taste of a fungus.

In the succeeding few days, during which I experienced stomach cramps and mild hallucinations which were symptomatic of mushroom poisonings, I realized incredibly that the operative had spiked the water with the Angels de Dios in a murder attempt.

On Oct. 25, 1979, two days after telling the neighbor about my identification of the iridium, Dave entered my house and stole my metals, along with my plans for the solar-voltaic system. Within about two weeks, the neighbor's crime-partner in Michigan announced "his" discovery and patent application on my process. On Oct. 26, 1979, I received a call from the neighbor, who invited me to his home, where he asked me to become a "partner" with him, "...to process the black sands for platinum metals" (with proof in hand, this offer showed that he not only hired the operative, but due to their frustrated efforts to discover my source of platinum concentrates, had mistakenly concluded that my source was from black sands). I did not respond.

Within about three or four days, I received a call from Steve Reynolds, a Chicagoan who was the New Mexico State Engineer. Reynolds explained that he had been requested by the neighbor and a group of "Chicago investors", to urge me to accept an offer by them to back me in a "metallurgical laboratory", to be built on my property. I did not respond. (The "property" involved was later taken away in the abusive lawsuits.)

In early 1980, the neighbor invited me to a gathering at his house, attended by the naturopath and his wife. The offer was repeated to me, and again, I did not respond.

In October, 1980, I was again invited to the neighbor's house, attended by a larger group, including the Chicago associates referred to by Reynolds (who were connected to what was once Meyer Lansky's "Chicago Syndicate", unbeknownst to Reynolds, who were cozy with the CIA). The neighbor and his associates threatened me by saying "You don't burn the mob". I answered that I could not possibly "burn the mob", since I had no dealings with them. They then proceeded to tell me all of the bad things which 'the mob' could do to a person. Again, I did not accept their offer. "The Mob" was the CIA.

In 1982, a second murder attempt was made, coinciding with the occupancy of the 'cocaine cartel' tenant who was the Columbian doctor's former wife. The would-be murderers worked with a St. Vincent's Hospital nurse (whose father was a Dade County, Florida banker involved in money laundering). The nurse was also married to a Columbian. Incredibly, all these people were also former members of the U.S. Peace Corps in Colombia, which is how they became associated with Klaus Barbie's cocaine cartel. The tenant furnished antibiotics supplied by her former husband, while the nurse furnished diseased sputum from the hospital. They attempted to grow a "killer germ", using yogurt as the medium, into which the germs and antibiotics were added. This concoction was added to some food and fed to me, on June 14, 1982 (my birthday again). My reaction the following morning, was a congested and sore throat, and yellow bile discharges. That attempt followed my 44th birthday, just like the June 15th, 1979 attempt. All the tenants from two separate residences were gone, having moved out during the previous night and early morning. The evidence they had carelessly left

behind was all over the place, most of which I still possess. The communist lady and her live-in boyfriend (a Hearst heir), left a candle burning against a wall, in an arson attempt foiled only by my discovery, just in time.

The criminal investigators for the Santa Fe Sheriffs department refused to allow me to file reports, either on the 1979 or the 1982 murder attempts, or related criminal activities. All of these people were among those I referred to in Chapter II (under "I Meet Torquemada and the Medellin Cartel"), who were involved in the drug dealing, communist/fascist politics, and money laundering, using straw-owners throughout Santa Fe County, the "Banana Republic" of North America.

In October, 1983, I was visited for the first time in New Mexico, by my 19-year-old son from my first marriage. My former in-laws—who were such great 'pals' with George Bush and wife, from their 1950s Odessa, Texas days—had managed, through threats, intimidation, political power and subterfuge, and the pure weight of money, to break off all contacts between my children and me after 1976, followed by a 1979 disappointment of a promised visit which was canceled. The sudden 1983 call from my son had re-established those broken contacts, but only for criminal purposes, I would later discover.

Between 1970 and 1976, during the trips I made to visit my children in Odessa, I had stayed at my parent's house. Ector County Sheriffs deputies would sometimes come to the house at night unannounced, enter the house without knocking or permission, search the house, and attempt to intimidate me or provoke a physical response, without probable cause, a warrant, or even a knock on the door. I knew that the Ector County Sheriff at that time was connected to the Chicago Mob also. You would be surprised to know how I came to know this fact.

Leading up to June 14, 1979 (my 41st birthday), my children had arranged to visit me in New Mexico for the first time, and I was very excited and happy about that. The in-laws canceled those plans at the last minute. The following day, the first of the four murder attempts was made by Dave, the old pal of the ex father-in-law, also connected to the neighbor, all being connected to the CIA. These traumatic events led to a break between my children and me. They were holding my children hostage to coerce my joining into the Mob/CIA operations.

I was then "excommunicated" by the in-laws from their church (the Eisenhower Church of Christ, in Odessa, Texas), to which I had never belonged. My children were forced to attend this open "excommunication ritual", thus subjecting them to Christian-Satanist "ritual abuse", using the entire congregation to buttress it. Though I am opposed to such "witchcraft", there was nothing I could do about it, since I didn't know about it until four years later. The children were forbidden by the church to associate with me after being raised by me as good, clean and clear-thinking Atheists, for the first six and seven years of their lives, without psychological problems or other complications. The children were suddenly and forcefully twisted completely around backward by this archaic and alien Satanist/Christian (they always co-exist, being mutually dependent) "religion", which worshipped a grisley 2,000-year-old myth and non-existent dead body of "Christ", based on the fantasy of "Christianity", created

originally by Josephus (A.K.A., General Arius Calpurnius Piso)⁷, on the old Luciferian model, to trick the Jewish revolutionaries in Rome and Jerusalem, into accepting a wimp "messiah" intended to make them docile.

My son later told me that for all those years, his grandmother forced him to sleep on the floor, in a closet, in a sleeping bag. That was his "room". This from greedy, stingy, sadistic "Christians", who were worth millions. The last time I had visited with him in 1976, he was twelve, and a world class swimmer, the champion of the West Texas Aquatic Association. He had Olympic promise. The following year, at age 13, he began to "mainline" (to intravenously inject) methamphetamine, and continued to do so for several years, during which the "Christians" concealed this information from me.

In 1982, in a sudden (and suspicious) turnabout, my son was "sent" to me, not to visit, but to attempt to get damaging information on me, so they could 'put me in jail', to atone for their guilt. As a good example of "...good Christian upbringing", my son had become a "meth-head". They wanted to make it look like a case of "...like father, like son.."—to misplace their guilt on me.

During my son's first visit, he made secret trips to the residence of a well-known Santa Fe judge, who lives in the nearby Eldorado subdivision, where he was encouraged to make out false police reports against me. He later admitted that the grandparents had arranged it all, and had threatened to disinherit him. The trip had been planned between the judge and the in-laws, with the promise that my son could gain 'penance' for what he had 'done to them', by helping them to 'get me'. So there was the victim of heinous Christian-Satanist child abusers, who had turned to drugs, his life practically wrecked for good, seeking 'forgiveness' from the criminally insane "pillars of the community", who had by their insanity, driven him into the streets, in his childhood.

A large part of the political arrangements in this scenario, were being carried out by the first cousin of the "Oil Queen", the retired Texas Ranger, George Renfrew (who also worked with the CIA), who was also the brother to my first wife's cousin's wife. I had actually broken bread with this man on several Thanksgivings, in Crockett, Texas. My son was apparently making clandestine visits to obtain instructions from this 'Strange Ranger'. I eventually found out about some of this, when a weirdo tenant filed a suit against me, and attempted to use the false reports against me in court. On realizing that the State of New Mexico was highly liable to me for the blatant CIA fabrications, the evidence was withheld by an embarrassed detective, who then sought to conceal the identity of the judge and the retired Texas Ranger, whose presence in the arrangement I was already aware of. The very gravity of this monstrous plot were about as outrageous a violation of a citizen's rights by high government authorities, as I have ever had personal knowledge of, and yet they happened to me.

At this time, I was having difficulty in separating things which I knew were connected to my former in-laws, from those connected to the CIA, until a succession of events revealed that they were all connected to the CIA, because my former in-laws had connections to George Bush, who was director of the CIA, and had several high level CIA employees in their family. Out of what appear on the surface to be "private-public conflicts", one may be led to more closely examine the facts, and to realize that the CIA is not a "public" institution, but a private one, created under the directions of the Federal Reserve Bank, and the group of other private bankers who perpetrated the fraud of the

⁷Abelard Reuchlin, The True Authorship of the New Testament, The Abelard Reuchlin Foundation.

National Security (Pseudo) "Act" on us in 1945, under which the CIA was created from the Gestapo's Reichsicherheitshaupt Amt VI.

During this time, my former wife was shot at along highway 285, by the retired "Texas Ranger", as shown by the following facsimile clipping from The New Mexican, which I entitle "The Big Ol' Bad Ranger Takes a Shot at a Pregnant Woman":

Santa Fe Police Report

SANTA FE - The following incidents have been reported by Police:

●The way the woman driver told it in a sheriff's report, she was driving along I-25 when a light blue pickup hauling a

horse trailer started tailgating her. After several miles the truck began to pass and as the woman looked out the driver's window she saw a man pull out a rifle and fire. The bullet went through her windshield.

The above can be attributed to that 'nice man'—George Bush—once in Washington, as a favor to an old "A-hole buddy", to motivate me to "go back to my first wife". Strange bedfellows indeed.

After the shot at my wife, she immediately became ill and miscarried our first child she was carrying within a couple of days, and almost died in the process. So the Ranger had actually committed the murder of an unborn child, and almost killed my wife as well. Perhaps that was his intent.

I found it hard to believe that the Rangers and the CIA would employ a man who would shoot at a pregnant woman, and be involved in a plot to drive away my second wife, so my first wife could "get me back". The plot was so bizarre that it reminded me of one of those old movies where some hillbillies in the Ozarks went out with their guns to bag 'em a husband for their homely sister. These people seemed to be too stupid to take "No!" for an answer. They failed to understand that even if they ran off my wife, and offered me the position of "King of the Whole Goddamned World", I still wouldn't "go back" to my first wife.

During my son's second visit, in January of 1983, I was almost killed for a third time, by a Santa Fe naturopath and his wife, who had been dosing me with minute quantities of arsenic for years, and finally gave me a couple of larger doses, to "send me home" for good. This couple, whose parents were connected to the C.F.R., were closely connected to the Paperclip-connected neighbor who hired the first and second assassins in the 1979 and 1982 attempts, and sued me in 1987.

In January of 1983, I went to the naturopath to obtain relief from back pains caused by work. The doctor applied accupressure and a massage oil to my back, which seemed to contain abrasive grains of something. That was probably not obvious to the doctor, since the back is more sensitive than the hands. The doctor probably thought the arsenic compound was so finely ground that I couldn't feel it. I simply thought that was the way

it was supposed to feel. He asked me to come back the following week for a "second treatment", which I thought was odd, but on his advice did so, on Feb. 4, 1983.

Between the first and second treatments, I had bloody bowel discharges which the doctor said was "...your system, flushing out harmful substances". Little did I know, but they were the symptoms of arsenic poisoning. During the second treatment, the doctor began to ask me personal questions regarding tax matters, which I thought was odd, especially when I discovered that his wife was also present, hiding beneath the covers of an adjacent treatment table. Again, the oil applied to my back had an abrasive effect.

In the evening following the second treatment, I began feeling nauseous, with pain across my kidney region and liver, as if someone had placed a steel band around my lower rib cage and tightened it. I awoke in the middle of the night with dry heaves and yellow bile. At that point, in deep despair and pain, I knew that something was drastically wrong. I remembered a conversation I once had with the doctor about "homeopathy", in which he had remarked that "arsenic is easy to kill someone with because it is cumulative, and you can give them only a pinhead amount each day, over a long period of time, and eventually kill them whenever they reach the toxic limit." At that point I realized the massage oil contained a granular form of arsenic which the doctor had obtained from the mineral formations at Ojo Caliente, a natural spring, where he often obtained such minerals supposedly for his homeopathy work, and had ground it with his mortar and pestle and added it to the oil. We called the Poison Control Center and confirmed my symptoms as arsenic poisoning, and I immediately took a hot bath to remove as much of the oil and arsenic as possible, and returned to bed. The bath should have been a cold one, because the hot bath only opened up my pores for the arsenic to enter faster, I now believe. At 5:00 A.M., my wife dragged me unconscious from bed, and with the help of her seven-year-old son, got me into the car and rushed me to the St. Vincents Hospital emergency ramp, from which I was wheeled into the E.R. in a dehydrated, semi-conscious state, with no pulse. They immediately began rehydrating me with electrolyte salt solution, as I began to go into convulsions. Three litres later, I was completely normal, the electrolytes not only having rehydrated me, but were the perfect chelation solution to completely eliminate all the arsenic from my system. I felt wonderful, where only moments before I was on the verge of death.

On learning that their murder attempt had been barely defeated by our timing and awareness of their plot, the naturopath eventually began to suffer remorse, calling me up on two separate occasions to confess, and to seek my forgiveness. I recorded both of these calls, then duped the tapes. The second call came around a week after the 1987 lawsuit filed by the neighbor, and he was afraid of being drawn into it. I believe my phone was tapped by the neighbor, who overheard the calls and became worried that the naturopath was crumbling. The lady sneak-thief was hired again to steal the tapes, but got only the dupes, at the same time that she got the aerial photo trial exhibits, which cleared the way for the Paperclip-connected neighbor to win his suit.

Around two weeks later, on a flight from Kathmandu to Nepal, the couple's Lufthansa airliner was seen to explode on the descending glidepath on the eastern side of the Himalayas, over Burma. Call it "poetic justice" if you will, but I call it a "cowboy hit", by people who sought to conceal the truth. The naturopath and his wife, along with 22 others, were killed.

I received cryptic confirmation within a few days, that the couple had been sacrificed by the CIA/ Illuminati, as a means of attempting to placate me. But I have

always believed it was to conceal the connection between the murder attempt and the large corporation which ended up with my solar-voltaic manufacturing process, and continues to make millions on it.

In the ensuing period between 1986 and 1991, my son served two prison sentences in Texas, both drug-related. His grandfather, who had lunch every week with the D.A. on a regular basis, simply had him put away because he had become an embarrassment to him as a deacon of the church. I found out about my son's conviction over six months later, through neighbors who were suing me. They kept track of stuff like that, because they were small-time cogs in the CIA's drug dealing machine involved in distribution of drugs being smuggled into the country to finance "black operations".

Though I am strongly moved by the "profit motive", these people kept me in continual poverty, induced me into business 'traps', and screwed up every money-making plan I had, ranging from real estate, metallurgy, and inventing. This book is the latest of my ideas to make a decent living, even though it has been on the stove for over thirty years. Since you are reading it now, they have not completely succeeded in stopping it, even if I don't make any profit. The NSA and CIA continually exert their influence through the big book dealers to suppress this book, spreading the disinformation that it is "permanently out of print" or "unavailable", which it never has been.

I have wondered if being part Indian sets a person up for persecution in America, either genetically or culturally. There seems to be a sort of pacific reticence which reflects a different attitude toward one's relationship to the earth and society, and a tendency to live and let live, to quietly mind one's own business. It seems that nothing invites the interest of a sadist more than a person minding his own business. The perfect chump. The ideal scapegoat.

In the 1870s, Jack Wilson, the Kiowa-Cree sachem (A.K.A., "Wovoka, the Paiute Messiah", founder of the Ghost Dance Cult) married into the Richardson Clan, in Anahuac, Texas, becoming James M. Richardson's son-in-law. Richardson ordained Wilson as a preacher of the Primitive Baptist Church, and Wilson in turn ordained Quanah Parker, all on the same day. Thus was created the Native American Church, complete with the peyote sacraments of Wilson. Richardson was my great-great-grandfather. We have an old family photo showing Wilson when he was in his early twenties, several years before the earliest photo of the Smithsonian's.

Most of the American Indian scholars have erroneous or distorted histories of how the Native American Church started, and have no history at all that Jack Wilson ever lived in Texas or had a family there. They usually trace the church's origin to Quanah Parker, failing to realize that Parker was ordained by Jack Wilson. The Primitive Baptist Church was originally called the "Primitive Baptist Church of England" when the Richardson's originally settled in the colonies in Virginia, since Benjamin Richardson was originally a Tory. After the American Revolution, The Richardsons were run out of the colonies, and settled in Mississippi. Afterwards, James M. Richardson fought as an American in the battle of 1812 in Mississippi, during the British invasion, and distinguished himself militarily, so the "...of England" was dropped along with the Richardson Tory sympathies. James M. Richardson then married a Natchez princess and moved to Texas, founding the first Protestant mission at Buna.

Jack Wilson apparently came into Texas to gather peyote for his Kiowa-Cree-Paiute ceremonies, and somehow fell in with the Richardson clan, was ordained by

Richardson as a minister, and married Richardson's half-Indian daughter. After fathering some kids, he disappeared back to his native Nevada, where he founded the Ghost Dance Cult, which contained elements of the original Primitive Baptist Church fused with ancient Kiowa teachings. The family apparently never realized what had happened to him. Quanah Parker, a half-Anglo Comanche, went on to found the Native American Church, including Wilson's peyote teachings.

It is my belief that the Kiowa are related to what Homer, the Greek poet, referred to as the Akiavoi or Achians, which to me means "East Quay People". As such, they shared the ancient Egyptian religions beliefs which were common to many ancient peoples. The Ghost Dance Religion taught that the Indians could "...dance all the dead Indians back to life", and in the meanwhile, the Whites would shrink until they disappeared. This theme contains elements from the ancient Egyptian religion, with significant variations. The U.S. Army officers did not like this idea, even though no violence was advocated.

Ironically, Wilson's movement—a sort of "American Gandiism"—eventually resulted in the senseless massacre of thousands of peaceful, innocent, already defeated Indians, by the U.S. Army, particularly at Wounded Knee, South Dakota. Clearly, the Illuminati did not want peace. They wanted the old 'fighting' Indians, so they could slaughter them. The technique is always the same. Bring in a 'new' enforcer, unfamiliar with and fearsome of the Indians (or other targets). Savage the dignity of a leader, by demanding compliance to something which serves merely as the provocation of a refusal, as the pretext for a violent 'enforcement', as 'justification' for murder or genocide, the same as with the Waco massacre, Tianenmen Square, or Wounded Knee.

I finally concluded, after being judicially tortured, imprisoned and impoverished by the CIA, that there just ain't no justice. To the Indians following Wounded Knee, the written and spoken word—in the guise of fiction, poetry, prose, or mythology—was a way to reach out for sanity, since protection by "law enforcement" authorities—from the violence of thugs induced by their bosses—was systematically denied. Yet it was merely the spoken word, singing and dancing which led to the extermination of the Souix leadership. A helpless warrior in the traditional sense, with his hands tied from doing what is rational and just, could be depicted in the most unfavorable light, like a Crazy Horse, and shot to pieces.

But I knew that I would have the last laugh. He laughs best who laughs last. I have the lasting satisfaction of knowing how bitter it will be for small and cowardly men to look back on their evil lives as they approach death, futilely searching for worthy deeds, only to come face to face with themselves as lowly cowards, with criminal genes from degenerate parents, educated in corrupt schools, destined to waste their meaningless lives taking empty pleasure in filth, degradation, lies, gangsterism, and ill-gotten dollars. And what an inspiration for their children! Criminals breeding more criminals.

When I was around 13, Max Evans, the western writer (who has a large dose of Indian blood), gave me a young bald eagle with a broken wing, to nurse back to health. We placed a splint on his wing, and I kept him until he was strong enough to fly, then set him free. Perhaps a year later, in the Davis Mountains over a hundred miles to the west, as I walked with a group of other Scouts through Apache chief Victorio's last stronghold, the eagle appeared and circled over my head, whistling shrilly, before perching on a nearby cliff to screech out to me, as the other Scouts watched in amazement. I explained to them that the eagle was "Screechy", a young eagle I had taken

care of, thanking me for his life, freedom, and health. I have never been able to approve of eagles in zoos. I composed the following poem a few years ago, in honor of all political prisoners, and eagles in zoos:

A BIRD'S RELIGION

Freedoms just a word that most have only heard,
but freedom's a religion, well known to every bird;
a religion of life, of love and liberty,
a bird's just not alive unless it can be free.

If a bird prefers a cage to the freedom of the skies,
he must depend on others for his food, or else he dies;
but the death of the spirit is the saddest loss of all,
for a mind which never rises can surely never fall.

To fly among the clouds or the limbs of a tree,
to land and mate and build a nest, and raise a family;
to love the other birds, being happy to be free,
is the only life a bird should live, the only way to be.

For we humans, our mind is our sky, and independent
thoughts are the wings on which we fly;
there are people locked in cages, their minds soaring free,
while prisoners outside the cages have thrown away the key.



THE KENNEDY EXAMPLES

At around 11:00 A.M., Nov. 20, 1963 (two days prior to the assassination of President John F. Kennedy), I had just arrived at my American history class at Sam Houston State University, in Huntsville, Texas, taught by professor Glynn Turner. The girl who sat behind me—a Miss Rather (newsman Dan Rather's younger sister)—had brought a copy of the San Antonio Light to class. The headline was something like "J.F.K. TO BE IN DALLAS IN TWO DAYS", with the Kennedy motorcade route advertised on the front page. I was somewhat familiar with the Texas School Book Depository neighborhood, since I had applied for work at a printing company in an adjoining building, in late 1962.

As a boy, my "blood brother" was Charles "Dusty" Warren, II, a Cheyenne-Cherokee cross, who was also the son of the Chief of Secret Service for presidents Truman and Eisenhower. Mr. Warren had absorbed five would-be assassin's bullets, in several attempts upon the lives of those two presidents. Through my friendship with Dusty, I was somewhat familiar with some basic security precautions established by his father, such as, that under the circumstances, a motorcade route should not be advertised. I also knew that, in a city such as Dallas, Secret Service agents would normally have been stationed in at least every other building or house along the way, and that, in no case, would the limousine be an open-topped convertible, especially where so many high buildings and potential assassin's perches existed, in a large city having a recent history of assassination attempts and other violence over politics.

The legendary loyalty and bravery of the Cheyenne made the choice of Dusty's father as Secret Service Chief a good one. Unfortunately, Mr. Warren was replaced during the Kennedy presidency, although he apparently remained on the security team.

On Nov. 22, 1963, since Dallas literally seethed with people having motives to kill Kennedy, it was a wisely chosen city for the assassination, with so many likely suspects to blame. For example, a disgruntled Madam Nhu, of Viet Nam, was in Dallas, brought there by anti-Kennedy political supporters. Her husband, Ngo Dinh Nhu, and his brother, the American-backed leader of Viet Nam, Ngo Dinh Diem, had been brutally and incompetently murdered by CIA Station Chief William Colby, and agent E. Howard Hunt, on Nov. 1, 1963, supposedly on orders of J.F.K.

Ironically, Hunt was photographed at the Kennedy assassination site three weeks later, near the "grassy knoll", just after rifle shots were fired from it. Dallas resident, General Edwin Walker, graduate of N.M.M.I. and of West Point Military Academy (and the youngest American commander to enter the Po Valley of Northern Italy, during WW II) had been kicked out of the Army by Kennedy, and had written a book saying it was because of his patriotic, anti-Communist views, and John Birch Society membership. There were scads of Cuban refugees, and veterans of the Bay of Pigs fiasco. There was Jack Ruby (a former Marxist-Leninist from Russia, later 'turned' and recruited by the CIA), who had been fingered by Bobby Kennedy in his book, as the key Chicago union figure who had set up the hit of a union boss, in order to enable the Mob to take over the Chicago union (there's the Chicago Mob again!). The CIA knew a 'good thing' when they saw it, a virtual Pandora's box of varied possibilities to cover up their assassination of Kennedy. On Nov. 20, 1963, I knew these things.

On seeing the headline and motorcade route, I picked up the paper, stood up, and said "They are going to kill J.F.K. in Dallas, day after tomorrow, right here" (pointing to

the street in front of the Book Depository). Incredibly, the professor and our entire class engaged in a 50-minute discussion of the Kennedy assassination, on Nov. 20, 1963, two days before it occurred, within 200 miles of Dallas.

In another incredible coincidence, Glynn Turner's (the professor's) brother, Matt Turner, would later be identified by New Orleans D.A. Jim Garrison, as the CIA agent sent out of Washington after the assassination, to clean up 'loose ends' (i.e., to eliminate any witnesses who could tie the CIA into the killing). Most of these "loose ends" were various and sundry scum-bags, prostitutes, petty criminals and other borderline characters, who had various pieces of knowledge which implicated the CIA, through the many people who were to be exposed in the eventual investigation. The 'coincidental' killings and mysterious deaths of so many of these people is what raised so many eyebrows during the ensuing controversy, following the assassination. Turner soon became the Bexar County (San Antonio area) Democratic party Chairman, appointed by you-know-who.

A few days after the assassination, the professor Glynn Turner invited me over for supper. Conveniently, Turner's brother-in-law, a Navy admiral, was there, in uniform, to ask me some questions, centering primarily around how I came up with the idea that Kennedy would be killed in Dallas, two days before it happened. I realized in retrospect that the 'supper' was actually an O.N.I. de-briefing, to determine whether I possessed personal knowledge of an assassination 'conspiracy'. The fact that I possessed no personal knowledge of a conspiracy, probably saved my life, I realized in retrospect. My best answer was that all of the apparent official indicia were there, to point my mind in the direction of an "insider-job" assassination, so my prediction was based on probability.

In the televised films of the assassination, I could see an agent climbing up on the trunk of the presidential limousine, in an attempt to shield Jacqueline Kennedy, then pounding his fist on the trunk after it was too late to do anything—a 'frustration-gesture' which said "I told you so!". It was more likely that Mr. Warren had been replaced as the head of Secret Service because they didn't want the wiley old Cheyenne to throw any tomahawks into their well-oiled assassination machinery. Had his procedures been followed, the assassination would probably have failed, though he had never faced such a concerted conspiracy in any of the three attacks against Truman and Eisenhower.

After the arrest of Lee Harvey Oswald, everything followed a classic K.G.B. "A-Apparat" ("Assassination-Apparatus") pattern, copied from the old Soviet N.K.V.D. As Oswald's 'second', Jack Ruby had developed 'sleeper agent' status with the Dallas police, and during a prisoner transfer at which he was conveniently present, he performed a classic Soviet-style assassination of Oswald, shoving his .38 directly up under his rib-cage, before 'gut-shooting' him, thus insuring little chance of his survival. This was S.O.P. under the old K.G.B. rules, after the apprehension of Oswald, to shield the assassins (in this case, the Illuminati/government plotters) from Oswald's possible testimony, but according to evidence discovered and relayed to the F.B.I. by Oswald himself, two days before Kennedy was killed, it appears in retrospect to be the way it was planned from the start, although police tried to kill Oswald at the theater in Oak Cliff, just after the assassination, but Oswald jammed his thumb into the gap between the revolver's hammer and cylinder, a stunt he had learned in his CIA training, which is why he had a bandage on his hand when Ruby shot him. That was the reason Oswald

screamed "I'm being made a patsy!" at the moment of his arrest at the theater.

Though Oswald did not shoot Kennedy, he had extensive personal knowledge of the whole operation, as a member of the hit team, extending over several states. The CIA had copied the old KGB procedures used by Ruby and the rest of the hit team, and the film showed that Ruby was very thoroughly trained and rehearsed for the hit. It is simply unlikely that a mere 'nightclub owner' would have been so familiar with such assassination procedures, or be able to carry them out with such finesse, without such expert training. Jim Garrison also identified Ruby as the CIA 'bagman' in the Dallas area, providing liaison and money to the various Cuban and other CIA-sponsored groups or other catspaws, a likely place for an ex-Mob man, who probably did a lot of skimming.

In early 1962 (before my Peace Corps training), I had organized and led a Young Americans for Freedom picket line, protesting "conventional warfare in Southeast Asia", outside a United Nations meeting in Midland, Texas, at which the U.N. announced its sponsorship of 'limited warfare' and 'counterinsurgency tactics', ostensibly to diminish the risks of all-out war. I viewed it as of an ulterior way for the Illuminati to 'blood our troops', in preparation for the coming Viet Nam war, to which the 'limited war' was to be escalated. This would ultimately maintain the Illuminati munitions manufacturers in the lavish lifestyles to which they had become accustomed.

In early 1963, two men matching Oswald's and Ruby's descriptions were seen taking a shot at the right-wing, closet-gay, General Edwin Walker, from nearby Turtle Creek Drive, in Dallas. This was a psychopolitical 'stage setting' for the future, intended to 'alienate' Walker from the future conspiracy, in which Dallas was the last of five alternative assassination locales, which could be actuated during Kennedy's political tour. The first four locations—Miami, New Orleans, Houston, and San Antonio—had been canceled as the tour progressed, leaving Dallas as the final and last chance for the hit, which was planned at least as early as Nov., 1962.

Kennedy's intent was to stop the escalation, and shut off the anticipated Golden Pipeline to the Illuminati, who killed him because he double-crossed them, after making deals with them to get elected. Kennedy's apparent original complicity in this war-for-profit-and-political-power scheme, was revealed by his formation of the Green Berets—as 'der Fuehrer's' personally sworn S.S. elite—and the 'closet Nazi' new uniform designs for the new counterinsurgency teams, which gave birth to the S.W.A.T. ("Special Weapons And Tactics") teams, almost identical copies the old Nazi Waffen S.S. and S.A. uniforms. "Jack-booted thugs", anyone?

Aside from his plan to shut off the planned Vietnam War, the thing which most surely contributed to his assassination, was Kennedy's issuance of debt-free currency, around a month before the assassination. This is the actual truth, Kennedy issued constitutional, gold and silver-backed dollars, which was cutting the cojones off the Federal Reserve gang. That currency change was immediately rescinded after the assassination, one of the first orders of business. Astounding but true, it proved that Kennedy was not a Keynesian, Fabian Socialist, but a 'hard-money' man, a constitutionalist, and a Libertarian, Jeffersonian Democrat.

J.F.K.'s older brother, Joseph P. Kennedy, Jr., was originally groomed for president from childhood. After his inadvertent death in a bomber accident in WWII, Jack became his replacement. Joseph P. Kennedy, Sr. ("Papa Joe"), US. ambassador to Great Britain, was in the Illuminati, like the Rockefellers, and was likewise a Nazi collaborator

and spy (F.D.R. blocked his prosecution for treason and espionage). The Kennedy boys even sat on Hitler's knee, during their visits to Berchtesgaden, the Fuehrer's Alpine retreat. The boys had been clandestinely raised to be American IllumiNazi leaders. After all, Bobby and Jack had 'proved' themselves, by supplying Senator Joe McCarthy the documentary "dirt" used in his hysterical H.U.A.C. hearings.

Jack Kennedy made promises he apparently intended to break, by first hiring 'Fabian Socialists' (Cambridge-trained closet fascists) in his administration, then firing them one by one, as he began to move away from the 'secret' fascist orientation which got him the power. Kennedy showed all the earmarks of heading toward a third, more Libertarian position (as I gleaned from Kennedy's book, Profiles in Courage, which gave a more 'real' profile of Jack Kennedy's rather undisclosed leanings). Kennedy was apparently purging male fascist types—affiliated with the Illuminati and national security establishment—from the government, similar to F.D.R.'s purge of pro-Hitler/Mussolini fascists from the cabinet of his second administration, and Mussolini's purge of International Socialists and Communists from his second administration (Il Duce was originally an International Socialist).

Kennedy had made public condemnations of "clandestine organizations" less than a week before his death, which many were led by the misinformationists to mean the John Birch Society, which I discounted, since close Kennedy family friend, Cardinal Cushing, of Boston, as well as Jacqueline Kennedy's cohorts—Oleg Cassini and Cholly Knickerbocker—and her father's family (the Auchinclosses), were sponsors of the Birch Society. The Birchers appeared to be anti-Kennedy (which could have been orchestration intended to create cover for his undisclosed agenda), but were not para-military. No..... Kennedy was talking about the CIA, not the Birchers. The CIA misinterpreted Kennedy's statements so the public wouldn't know there was a squabble between Kennedy and themselves, or the Federal Reserve Bank, only a week or so before they planned to kill him and blame it on the "right wing" or "Castro".

Kennedy's purge shouldn't be interpreted as a patent homophobic bigotry, but rather one which frequently involved CIA-connected homosexuals, who were in high ratio among the Templar-Illuminati pederast variety, such as a whole nest of them who were classmates in the '30s and '40s at New Mexico Military Institute ("NMMI"), in Roswell, New Mexico. Those 'good Ol' boys' were lavished with lucrative defense contracts during the three or four wars since, or were placed in prestigious government or military positions. Like the graduates of a particular secret P.O.W. camp—non-coms included—they have all been well taken care of, to the man. Several of them who were directly or indirectly victims of the Kennedy purge, were naturally implicated in the assassination. Just take a good look at the defense contracts for the Viet Nam War.

During WWII, Joe Kennedy, Jr., like many other 'Illuminati sons', was to be kept safe in the special P.O.W. camp in Bavaria, near the Swiss border, in Adam Weishaupt's old stamping grounds. On allied bombing raids, 'certain' bombers made 'protected' landings, and their personnel escorted to the special camp, where they were treated like royalty by the German command. Joe Kennedy's plane was accidentally shot down, or crashed on landing, killing him. These arrangements related to the traitors mentioned in Charles Higham's Trading With the Enemy, who through special connections to Hitler and his financial supporters, acquired these cushy accommodations for young officers who were in their families or spheres of influence.

Joseph Katzenbach, Kennedy's A.G., and graduate of Yale law, class of '47, learned international law in the camp, supplied with all the books and materials he needed, by the Third Reich. Similarly, several others 'vacationed' there throughout the war, to emerge at its end as 'hero' P.O.W.s. I have personally met at least six of these former "P.O.W.s". Some of them have gone into politics, some are in banking, international trade, defense and government contracts, hotels, etc., but all of them are, or were, well provided for, and kept "safe", except for one poor non-com I knew who just happened to be on one of the special planes, as a crew member. His 'reward' was being a high school teacher. He wasn't treated like 'royalty' by his Nazi captors. He was a Sephardic "crypto-Jew", whose spirit was broken.

Without their special connections, these IllumiNazis would have been no more capable of achieving success than anyone else, in a truly capitalist society. Almost all of them had marriages arranged through Illuminati-aristocratic channels. Jacqueline Bouvier Kennedy's eminent family connections included direct ancestry from most of the royal families of Europe such as the Hapsburgs, including Lorenzo di Medici, of Firenze, Italy, the renaissance era inspiration for Nicola Macchiavelli's *The Prince*. Do these matters indicate more than what Ayn Rand called the "aristocracy of pull", revealing an actual unconstitutional, clandestine perpetuation of power through inherited "titles of royalty"? The coincidences are too strong to be ignored. The particular lineages appear to be those considered by the Templars to have been directly descended from Jesus Christ.

The Kennedy assassination will be kicked around for many years to come, but I will say here and now that it was engineered by the CIA, on behalf of the Federal Reserve Bank, the CFR, the military-industrial complex, and the National Security thugs.

THE HISTORICAL EXAMPLES

Where people are free to produce and trade, there should be no problem. Food production is the ultimate key to freedom, and the freedom of people who produce it are essential to a free and independent society. Even "rich soil" can be created by any one, provided they have the freedom to do so. To the contrary, control over food production is one of the primary Trilateralist priorities, ergo a war against farmers and ranchers.

The Illuminati is precipitating world-wide death on what should be the eve of world freedom. The "cattle mutilations" experiments appear to be a research and development project, in which flying saucer-borne "death ray" guns are used to shoot cattle, after which tissue is removed from them to examine for particular damage to the reproductive and immune systems, for the purpose of developing "stealth murder weaponry", in which human victims may be murdered in such a way that their deaths appear to be from 'natural' causes. "Population control" and political assassination come first to mind. This is to make possible perpetual Illuminati world control, based on the original scheme devised by Hassan I Sabbah (founder of the Order of the Devoted in 1093), based on the pantheistic teachings of the Persian, Abdullah (c. 11th century), whose teachings included the Tibetan Bonpas Doctrine Of the Non-Ego, which had come to Persia through the peripheral gnostic Sufi teachings of the Roshiniya and Thuggee murder cults seeking to overturn Islam and restore goddess worship, and to control the world by assassinating and replacing leaders with their kind.

In the 1920s, Stalin exterminated the last resistors to the Red Army—the Kulac "peasant" farmers of the Ukraine—because of their rejection of communism and their emerging prosperity and strong middle class. This holocaust sacrificed the 15-foot thick "rich black soil" of the Ukraine, and the people who farmed it, to the Soviet Thuggees, using Illuminati-procured American food, money, and machinery, to supply the Red Army, under the "Lend Lease Program". In payment, Illuminati arrangers like Armand Hammer acquired such looted art treasures as the Faberge eggs, from the Swiss bank vaults of V.I. Lenin. 'Soviet' agriculture never recovered from the loss of the Ukrainian Kulacs ("fists"). The Ukraine and its rich black soil—without the Kulacs—is just so much untilled prairie. The tattered remnants of those Kulacs were beginning to regenerate. The Illuminati could not allow this fertile region to once again supply needed food and profit for a re-vitalized Ukraine, which could capitalize on feeding and strengthening a large part of the world, and threaten Illuminati food control.

On the eve of Peristroika, the Chernobyl disaster was arranged by the Illuminati, to poison the blood and soil of the Ukrainians, to deprive the food and spiritual resolve needed for them to break with the Soviet system, to rebuild their former strength and health, and most of all, to resume the food production of the fertile Ukraine. The Ukraine was dealt yet another devastating blow, by the spewing of radioactive poisons out upon the Ukrainians. The Kulacs were originally Germanic peasant farmers imported by the Czars, to farm the Ukraine. Actor Jack Palance, an Ukrainian by birth, described the Chernobyl disaster as "a desecration".

The Ukraine lost 7 million Kulacs in Stalin's pogrom, another 7 million in WWII, and several more millions in Stalin's insane "purgues". Were these sacrifices to Kali Ma, on behalf of the Illuminati murder cult, or an English-American conspiracy to exterminate "all Germans", or both?

As stated in Chapter I, Synopsis of Facts, No. 14, "Morgenthau's Pastoral Policy"⁸ was a factual reality, as I learned in 1968, on the very night that L.B.J. announced that he would not run again. On that evening, Texas Governor John Connally sponsored a "Gala for the Arts", to which I was invited. The L.B.J. message was delivered to an astounded Connally, during the Gala, just before the intermission. Prior to the Gala, as I enjoyed a libation with other graduate students, within a block of the Main Building at U.T., a young Ph.D. candidate in history, stated that his dissertation was on the Treaty of Versailles. I brought up Morgenthau's Pastoral Policy, stating that I had heard that it was a hoax.

The student smiled, then said "Come with me". We walked to the Main Building (the "Tower") at U.T., and went to of an upper floor where the papers of L.B.J. were then stored, until the Sid Richardson Research Center (then under construction) could be finished. The student entered a vault and emerged with a document. He asked me if my hands were clean, instructed me to hold them out, and placed the 1919 document into them for my examination. It was stamped with a reception number and seal of the Versailles Committee, and signed by president Woodrow Wilson. It truly advocated the

⁸A document drafted by Hans Morgenthau, Sr., and presented to the Versailles Treaty Committee, Paris, 1919, by president Woodrow Wilson, the original document being among the collected papers of president Lyndon Baines Johnson, now kept at The L.B.J. School of Public Administration, The Sid W. Richardson Research Center, University of Texas, Austin.

"extermination of all Germans", and the "...reduction of Germany to a pastureland...", because the "...Germans are an inherently warlike race". It was proof that the Illuminati had no stake in the Germans as a "race", and had manipulated them with false "Aryan" propaganda via the S.S., which was founded by the Illuminati later that same year, after Morgenthau's Pastoral Policy had failed at Versailles. It is a well-known fact that at the time, president Wilson was so sick that he was of an easily-manipulated puppet of his CFR/IIA 'controllers', and died soon afterward.

In 1919, Colonel E. M. House was one of those nutty, megalomaniacal Texans who, like all modern self-proclaimed Zionist messiahs, declared himself the be "God". As the adviser to President Wilson, he went to Paris to establish liaison between an American group and its British counterpart, which called itself the Round Table, which had grown out of British diamond and gold magnate Cecil Rhodes' fanatical world government concept, having as its goal the establishment of world-wide British imperialism. Rhodes was a disciple of elitist aesthete, Professor John Ruskin of Oxford (a proponent of the Pythagorean 'Golden Mean' and other Hermetic theories), and a follower of Adam Weishaupt and Illuminism. In his will, Rhodes instructed Lord Rothschild to expand the Round Table, which, like the German S.S., was structurally patterned after the Freemasons and Jesuits. At Paris, a new organization arose, which mooted and replaced the League of Nations, called the (Royal) Institute for International Affairs ("I.I.A."). In New York, it was called the Council for Foreign Affairs ("C.F.R."). The two groups merged at Paris, in pursuit of a British-American dominated world government. The group was financed by Rhodes and his friends, the wealthy international bankers. "Morgenthau's Pastoral Policy" was one of the group's earlier plans. When it failed, they financed the S.S. and chose Hitler to lead Germany.

By exterminating the Germans, Britain and the U.S. would have moved a step closer to British-American world imperialism. The C.F.R. used both right and left strategy. It financed the Russian revolution, helped set up the S.S. in 1919, financed Hitler's rise to power in the 1920s (in fact, chose Hitler from among several candidates, in 1923), and promoted international socialism through the U.N., which it founded through their agents who were guiding U.S. policy in 1945. That was the "New World Order" of which Hitler spoke, which was to come about after the 'weak' had been destroyed in the coming war. That 'order' has been in effect since the close of WWII, at least on paper, except its founders have never been able to fully put it into effect. They cannot figure out how to tell us it is "the law", since there are so many little stumbling blocks in our constitution standing in its way, such as the phrase "...this Constitution...is the Law of the Land", and "...these Sovereign united States". The C.F.R. is currently engaged in destroying U.S. sovereignty, and now envisions a New World Order embracing both Communism and 'state-capitalism' (i.e., fascism). The U.S. and Britain are apparently the leading models for the new world fascist state, which will be, like that envisioned by Hitler, composed of "national-concentrationist" entities which have no real sovereignty. In the future, any one of them which gets out of line, will be thrown into a war with its neighbor, as the U.N. troops arrive—like the cavalry—to 'settle' the dispute. If one speaks of the "Illuminati" today, he must include the C.F.R. They must weaken us to make the plan work.

When Wilson went to Paris in 1919 to present the "American" plan (to exterminate the Germans), to the Versailles Committee, what was to become of the German "real estate" (what we know as "Germany") after the Germans had been mass-murdered and

buried under Morgenthau's plan? Did Morgenthau have any ideas about what to do with that empty German "pastureland"? And what about all the gold teeth fillings, eye glass frames, jewelry and other personal valuables? Soap, anyone? Lampshades?

Hans Morgenthau, Sr.—the author of the policy—was an anti-Zionist, 'emancipated' Sephardic Jew, while his son, Hans Morgenthau, Jr., was a Zionist. As you may know, Theodore Hertzl, also Sephardim ("Sun-Hare-People", or "Aryan") was astounded in 1897, when the Russian disciples of Karl Marx—the Ashkenazim from Moscow—showed up in Basle, Switzerland at his first International Zionist Congress and took over his organization. Both the Sephardim and the Ashkenazim ("East-Canaan-People")(also called the Khazars, which means "Goose-Hares") came from the same type of Osiris/Sun-Hare/Isis/Sun-Goose-worshiping Aryan/Canaanite stock, yet had a different history since about 1,500 B.C., but Morgenthau probably didn't realize it, or care about it for that matter. Such "world power" types, including Hitler, Rhodes, House, etc., were megalomaniacal-messianic flakes anyway.

Like many other "German Jews" (Sephardim), Hans Morgenthau, Sr., had an almost pathological fear of the "Ostjuden" (Ashkenazim)—those Uralo-Altai-speaking-Tartar Khazars, whose kingdom in 600 A.D. stretched from the Black Sea to the Caspian. These Schythian-related people had originally been converted to Talmudic Judaism around 679 A.D., and to a Sephardic like Morgenthau (whose families had for centuries lived as the Nobility of Jewry), the Ashkenazim were considered inferior, illegitimate, "counterfeit Jews", because their (particular branch of Canaanite) lineage had not descended from the "Hebrews" or "Children of Israel" who purportedly were "enslaved by the Egyptians"... "followed Moses into the Promised Land", and "lived under King David or Solomon" in the United Monarchy of Israel, nor were they part of the Diaspora from Babylon. To Morgenthau, they were no more "Jewish" than the Phoenicians, Sumerians, Finns, Turks, Scythians, Ukrainians, Celts, Scots, Irish and Britons, etc., to whom they were related.

After about 1,000 A.D., the Ashkenazim were moved around all over Russia, Poland, the Ukraine, and Lithuania, and had, as an oppressed people, emerged as the controlling group in the Communist Revolution. Stalin, Trotsky, Lenin, Molotov, Kruschev, Beria, and numerous other Communist leaders were often of the Ashkenazim. This affiliancy to the Communists (Trotsky had recruited and trained his Red Army Cadre in the Bronx in 1916-17, financed by the Jacob Schiff, Kuhn and Loeb and other international banking firms headquartered in New York), and to the Zionists (whom they had taken over), undoubtedly reinforced Morgenthau's fears desire to appease the Ashkenazim, Zionists, and Communists. In 1917, the international bankers, with the aid of German foreign minister Zimmerman, arranged for Trotsky's cadre to take their famous train ride through Germany, to rendezvous in St. Petersburg with the returning P.O.W.s from the Russo-Japanese war, who had been indoctrinated (courtesy of the bankers) while still in the Japanese prison camps, with Bolshevik propaganda, and trained into the Red Army structure specified by Trotsky.

Perhaps Morgenthau thought Germany would make a nice new Bolshevik or Zionist homeland for the Ashkenazim in Germany, and keep them out of America, after which they might show their eternal gratitude to Britain and America, and buy lots of goods and make deals as part of the scheme. Was this a plan of appeasement of the Ashkenazim? It is hard to imagine that the bankers sincerely wanted a Communist world, in which they would be economically "equal".

In the 1920s Ukraine, the acts of Stalin—the former priest, who knew that soil alone produces little food—weren't 'accidental', and neither was the Chernobyl disaster. No Ukrainian would have done it to his beloved. Even a communist would not have done it. Only the Illuminati stood to gain—like their Nazi and Communist spawn—as a bunch of Thuggee incompetents, whose only harvest was death and destruction.

How they gonna keep 'em down on the collective farm, once they've seen California or Montana? Ukrainian farmers can grow food anywhere. They do it from Northern Canada to South Texas, attracted to the rich soils of North America—scientifically named for Ukrainian soils—like iron to magnets.

Farming in today's Ukraine is pitifully low. Despite relatively large incentives offered to young people to take up farming in the Ukraine, there are few takers. A lot of the food comes from areas where agricultural people survived, more or less overlooked by Stalin or the Illuminati. Moldavia provides some food, from the rich soils near the Moldau and Diestr Rivers and tributaries. Women from the Ukraine, Moldavia and Georgia travel over a thousand miles to Moscow in the warmer months, to sell fruits and vegetables on the streets. Many of these women have university degrees.

The Illuminati wants to maintain control of the C.I.R. during its transition to "capitalism", to make sure that their favorite brand of mixed-economy, corporate-state fascism predominates. An increasingly productive Ukraine would encourage a transition to true capitalism. State-capitalism and Laissez faire capitalism are immiscible. The present food shortage in the C.I.R.—created by the Illuminati to slow the transition down or make it impossible, while gaining transitory control—is due to the physical and psychological shock of Chernobyl, and the inability to recreate capitalism while eliminating the controls of the old Communist system. Originally intended to force the Ukrainians and the C.I.R. into starvation, it instead accelerated the breakup of the Soviet Union. Now the Communists are back in control.

The phony "fuel crisis" of 1974 was created to regain control over the American economy which the Illuminati had lost between 1970 and 1974, largely from "hippy technology" which had evolved in the pseudo-communes of that period, through a significant outburst of alternative energy creativity, greater independence, and greater economic resiliency, which caught the Illuminati by surprise, as the Viet Nam War ended. This development was due primarily to an increased appropriation of materials, techniques, and equipment, by ordinary citizens and entrepreneurs.

The Illuminati-created 'fuel crisis' was tantamount to the "leveling laws" of 19th century England, in which a high tax was levied on window panes, to oppress the nouveau riche who had arisen during the English industrial revolution. Those too poor to afford the new taxes on window panes, had to get rid of them, with a drop in socio-economic rank. Without these accouterment to their homes, they were unable to entertain guests in the same fashion as the elite, and to thereby acquire the social status necessary to rise in the business world. Ironically, as if an added penalty under the "American leveling law" (the false 'crisis'), Americans seeking new solar equipment and window panes, to alleviate the 'crisis', would have to buy supplies and equipment from the same Illuminati corporations which had created the crisis. This quandary spurned more creativity, and even more economic resiliency.

The preoccupation of the Illuminati with regaining control of the runaway American economy, resulted in their loss of control over the Soviets. We suffered a

considerable set-back, while the Uluminati got much richer, thanks to government favoritism, but our set-backs were somewhat offset by increased economic toughness.

The "Watergate Conspiracy" (another hoax within a hoax), was instigated in the wake of the fuel crisis, to compound political disillusionment with economic distress, in attempt to collapse the American economy. The break-in and subsequent 'leak' to the press was engineered by the Illuminati through the F.B.I. and CIA, using the same people who murdered J.F.K. Their idea was also to stop Nixon from freeing the Chinese, or opening up the new Asian markets. The Illuminati "divide and conquer" concept requires a divided world. Nixon was erasing too many barriers, making too much peace. They merely exploited the natural weaknesses of Nixon and his cabinet.

The Illuminati divides Texans and New Mexicans to maintain control of the mineral and oil wealth in the two states. The illegitimate accumulation of fabulous wealth by the military-industrial complex, was procured by creating divisions between the Americans, Soviets, Chinese, the West in general, and the Middle East, primarily through religiously motivated exterminations, wars, and revolutions. Can you see them giving up without a depression or another war? And who shall fight whom?

The Illuminati exploits dormant hatreds, creates divisions upon which wars, economic exploitation and deceit are built, motivates all parties at "their own levels", and sets up each new play of the game. They divide the Muslim world against itself, and use "Christianity", "Judaism", "oil", economic interests, ethnicity and nationalism as wedges, to create more homogeneous societies which are more easily steered into bigger international wars and Illuminati control. The Christians-versus-Muslims squabble in post-Communist Yugoslavia requires a closer look at the big picture.

Through us, the Illuminati backed ultra-conservative oligarchic Muslim Saudis and Kuwaitis against 'socialist' Muslim Iraqis, in the "Gulf War", in order to keep the Golden Pipeline to Wall Street Illuminati banks intact, and to keep the Russians out of the international oil markets, because they have vast petroleum reserves. The Illuminati deftly plays all things to all people, like bisexual whores at a transexualist convention.

The constant irritation of the Iraqis by the U.S. government is a dangerous game. It is only a matter of time, if such bullying continues, until angry Arabs rises up and "sting" America like a stirred up hornet's nest. It is a grave mistake to consider the Arabs easy prey for our military. A look at the past few years shows that the constant assault on Muslim Arabs has not only solidified their political resolve, but made Americans the unwelcome "ugly Americans" in that part of the world. How long will it be until a nuclear weapon is detonated in New York City or West Palm Beach?

The Illuminati is not an Illuminati, but a Pseudo-Illuminati, "bringer of darkness", what the Tibetans call the "black magic" of the pre-Buddhist Bonpas murder cult, so powerful and feared in Tibet that few will speak about it. It was the cult written about by Theodore Illion⁹, who visited the cult's underground headquarters, where he was invited to join the elite and refused to do so. He escaped, was hunted throughout Tibet by the cult, escaped, returned to Germany, and lived to write about it. This was undoubtedly the "unknown underground masters" of whom Hitler spoke. How does this significantly differ from the CIA?

⁹Theodore Ilion, *Darkness Over Tibet*, (reprint of 1937 original, Adventures Unlimited Press, Stelle, Illinois, 1991).

CHAPTER VII: FROM THE EASTER BUNNY TO AUSCHWITZ: THE RELIGION OF EINSTEIN AND THE NAZI NEW-AGERS

The previous Chapter VI was the consummation of the over 17 years of overt judicial harassment which ensued the moment George Bush took the reins of power at the CIA, and ended with his Presidency. Bush is a pal with fellow Trilateralist and Republican, Robert O. Anderson, the man who controls the North Slope of Alaska and the HAARP project, though Anderson would now probably disavow any connection to ARCO, which he created. Chapter I can be thought of as a kind of "Revolutionary Manifesto of Laissez Faire Capitalist Creatology"—(i.e., a manifesto of a radical and new artistic and scientific religion, based on the "Science of the Creative Process").

The Illuminati originated with "luminism", or Mithraism, related to the myth of 'Osiris the Beautiful Hare', an over 6,000-year-old religion, devoted to sun-worship. As a solar god, Aestre (Easter, Auser, Oser, etc., the "East Hare of Light and Goodness" [Ahuramazda]) is also the origin for "Aryans" ("Hare-ians"), or worshippers of Osiris. These included Moors, Greeks, Turks, Mongols, Norse, Schythians, Scots, Irish, Celts, Semites, Arabs, and Syrians, etc. Many tribal names derive from the "hare" word, often combined with the "duck" or "goose" word (emblematic of Isis, Osiris' mate), as do many other words in Asia, the Middle East, North Africa, Europe, and North and South America. For example, "Schythian" means "Duck-Hares", a word which is "Scutari" in Turkish.

The word "Aryan" did not originally denote a race, but rather a religion. However, it later came to be misinterpreted as a race, by the leaders of neo-Pagan religious movements of the 20th century.

THE "MODERN ILLUMINATI" AND THE NAZIS

In 1776, Adam Weishaupt, a Bavarian Jesuit priest, and professor of Canon Law at Ingolstadt University, "reinstated" the secret, "Illuminaten Orden", infiltrating the Bavarian Masonic Lodges and instilling the Johanite Gospel, requiring a compulsory belief in "Almighty God", and excluding Atheists and Jews, converting the lodges into instruments of mystical and racial control. Though declining in 1790, the Illuminati was still alive, resurging again in 1912, particularly in 1914 Austria, fabricating the pre-Nazi "Thule Society", a "neo-Gnostic" racist group, teaching that "Aryan was good, and Semitic was evil". This was begun by Joseph Lanz von Liebenfel's Ostara religion. Members were apparently unaware that they were worshippers of the "Easter Bunny", and that they, as Germans, shared a common racial origin to many of the Jews. The program against Masonic acceptance of Atheists or Jews, eliminated their potential influence. The Illuminati had a secret world government plan, maintained by compartmentalization, implementing mystical and racial national concentrationism. A 'schism' created between Christian (Prussian) Masons and Atheist and Jewish (and later Zionist-Atheist) Masons, was similar to the Lutheran Reformation, in which Martin Luther's anti-Semitic book, entitled "The Jews in the Catholic Church", isolated German Christians from the ideologically competitive 'foreign' influences of the Roman Catholic Church, by pointing out Jewish financial influence in Roman Catholicism.

During this time, the Illuminati made inroads in France, via the Jacobins and French Masonic Lodges, during Napoleonic regimes, and into Spain as the Alumbrados, who soon found themselves being sponsored by the Duke of Pachucua, a knight of the Spanish Royal Court, in Mexico. This eventually gave rise to the Penitentes in Mexico and the North American Southwest, in which secret members became known as "Pachucos", named for their earlier official sponsorship by the Duke of Pachucua, and their American origins in the Mexican state of Pachucua. Like the Thuggees of Asia, some Pachucos were required to perform certain criminal acts, and openly wore tatoos on their bodies, later concealed in the folds of their hands, after the F.B.I. outlawed them, declaring them criminal and subversive. As a boy, I knew many of them.

According to one of my uncles, a 32nd Degree Mason, and a Catholic, of "Cajun" origin (who was never excommunicated for his Masonic activity), the American Masonic Lodges refused to accept French Masons into American Lodges, after the time of the Marquis de Lafayette (a friend of George Washington and Thomas Jefferson, converted to Masonry by Jefferson), because of the infiltration of the French Masonic Lodges by the Illuminati.

When it went out the door with the expulsion of the Emperor Maximilian, the Napoleonic Austrian puppet government of Mexico left behind the Mexican National Anthem, Under the Double Eagle (Unter den Doppel Adler), an Austrian march (written by Richard Wagner, the German composer) referring to the "double eagle", a symbol which can be found before 655 A.D. on a gold and enamel purse cover from the Sutton Hoo Ship Burial (now in the British Museum). The emblem was carried by German and Austrian Christian Knights Templars, during their crusades against the Muslims, and is a Masonic symbol often seen on Shriner rings. The symbol had already found its way into the Roman Empire during the days of the emperor Trajan, when Germanic slave-artisans from the north were imported to decorate Roman architecture and monuments. The double eagle became popular during the time of the first 'Holy Roman' emperor, Constantine Porphyrogenesis ("Born of the Purple"), the son of a German officer in the Roman Legions from Trier, and a Hungarian mother.

When my ancestors, the Fosters and the Richardsons, brought the Mexican Napoleonic-dictator, Generalissimo Santa Anna, before General Sam Houston, after his capture at the Battle of San Jacinto, they first tried to hang him, until they saw the double-eagled Masonic ring on his finger. Instead, they sent him back home via Washington, where the Mexicans eventually decapitated him, double eagle and all. The ring showed his membership in the Jacobin/Alumbrado lodge of the Napoleonic regimes. Sam Houston was a direct descendant of Phillip II of Spain, and according to the Templars, Jesus Christ.

John Baptiste Lamy, Jesuit Archbishop of the Archdiocese of Santa Fe, refused the Holy Sacraments to Penitentes, unless they swore an oath disavowing the Penitente/Pachuco secret sect. Lamy excommunicated those who refused, thereby also stealing much of the lands of their "brotherhood", El Rancho de Nuestra Senora de La Luz (The Ranch of Our Lady of Light), and several others, the titles to which were granted to their predecessors-in-title, by the "pre-Napoleonic/Illuminati" (Alumbrado-influenced) Spanish king, Phillip II, who was also a Hapsburg (from the House of Esterhazy ["East-Hare", or "Osiris", whose 'house' was at Busiris, in the Sixth Nome of Lower Egypt]). The Penitentes represented a "fundamentalist schism" to the Illuminati that Bishop Lamy knew and loved so well, and represented a threat to the

exclusivity of secret control by the Jesuit Order, which is jealously intolerant of any secret organization other than itself, in any territory it controls. The "Penitentes" represented an undisciplined, unexpected, and intolerable branch of the Illuminati, which had fused its elements with those of Native American Indian populations, and had to be "pruned back" by the Jesuit Order in the 19th century, and by the F.B.I. in the 1950s. Some have even said that J. Edgar Hoover was a Jesuit priest.

Figuring into all this was the "Holy Grail" and the "Golden Cup Ceremony". Its earliest known pre-Christian origin seems to be from Indo-Sumerian traditions, which related to the Uralo-Altaiic-speaking tribes in Western Siberia, from which the Schythians (Scot-Irish), Turks, Koreans, Japanese, Finns, Celts, Sumerians, Hittites, Minoans, Britons, Saxons, and many other tribes descended. Incorrectly thought by some to be Buddhist, it was actually practiced by the more ancient, pre-Buddhist, Bonpas religion, of Tibet, which worshipped "black magic" and "Kali Ma" ["Bloody Mother", the "Goddess of Chaos"], with obvious affiliation to the Thuggee cult, the Society of Assassins, and the Death's Head S.S. Black Order ["Schwartzte Korps"].

The Bonpas, Thuggees and Assassins believed in a "collective consciousness", and that, as the population of the world increased, this collective consciousness was "weakened" by being shared by too many people. In service to "Bloody Mother" ("Kali Ma" or Kali Matrakis), they believed in killing as many people as possible—preferably everyone—so as to strengthen the "collective consciousness". Unlike the S.S., Bonpas, Assassins and Thuggees wore white robes with red sashes. (In one photo however, Hermann Goering can be seen wearing a white SS uniform with a white belt having a thin red line on it.)

In 747 A.D., Padmasambava brought Buddhism to Tibet. He supposedly killed or drove all the Bonpas out, but they just went "underground"—figuratively and literally. Padmasambava "ceremonially" incorporated the main idea of the Bonpas—the Doctrine of the Non-Ego—into Buddhism. The original ceremony of the Bonpas, entailed actual cannibalism, in which the hearts of sacrificial victims were eaten, and their blood drank in the Dance of the Red Tiger Devils⁰ The Buddhists however reject actual cannibalism.

The "Holy Grail" or "Golden Cup" myth survived in Germany through the Nibelungenlied (the bloody pan-Germanic epic, in which Attila the Hun is believed to be the wise old uncle). Descended from Tibetan and Uralo-Altaiic/Sumerian origins, the Golden Cup myth eventually became associated with the libation cup of the Celto-Nordic peoples. As explained in Plato's Timaeus, the ten Gods of Atlantis commenced their gatherings by collecting the blood of a young bull in the golden cup. This is evidenced by the two beautiful, Late Minoan, golden Vaphio Cups, found in the Peloponnese, upon which are depicted several ancient Minoan "cowboys" lassoing young bulls.

The Golden Cup, or Holy Grail, eventually became the double symbol of "knowledge", and of "pure blood", in the diseased minds of Nazi theorists. Among Heinrich Himmler's list of required reading for S.S. initiates, was Crusade Against the Grail and Lucifer's Court in Europe, by Otto Rahn, Colonel, S.S., a member of a society called the "Ahnenerbe". "Lucifer" (meaning "Light-Hare", from "Luci- +

⁰Tibetan Yoga and Secret Doctrines (Wentz Oxford U. Press, London).

"-fer") identified the Illuminati (and Naziism/Trilateralism) as an "Osirian" cult, with the "Holy Grail" (Golden Cup and bulls) as one of their sacred myths.

In the 7th century, A.D., the Christian Holy Byzantine Emperor, Justinian, drove 40,000 Mithraists (worshippers of Osiris) into a hippodrome in Asia Minor, and exterminated them. Justinian married a dancer, Theodora, whom he met at the Circo Massimo in Rome. Over 1300 years later, Hitler also married a dancer, Eva Braun. Justinian reinstated "proskynesis" (the Roman salute, "Hail, Caesar!"). (Incidentally, Caesar, Kaiser, and Czar mean "Goose-Hare", in reference to the Sun-Goose...Isis...and the Sun-Hare...Osiris.) Hitler did likewise. Hitler and the Thule society eclectically copied the fanaticism of early Christianity, and several secret societies, combined with the aggressive expansionism and organization of the Roman state.

The Ahnenerbe Society ("Society for the Study of Ancestral Heritages", i.e., Indo-Germanic racial research), was supposedly racio-theological in nature. In Jan., 1939, Ahnenerbe was incorporated into the S.S., and already had fifty branches, led by Prof. Wust, teacher of Sanskrit at Munich University. Meetings of the general staff of the S.S. began with Yoga and a Bonpas/Bhuddist "Sesshin". The Ahnenerbe, which maintained constant contact with Tibetan Bonpas lamas, also contained the mystical Black Order ("Schwartzte Korps"), the S.S. "inner circle". Ahnenerbe's general manager, S.S. Colonel Wolfram Sievers, was hung by the Tribunal at Nuremberg.

Ironically, a majority of the ancient "Sea People" tribes from whom many of the Israelites under Solomon's short-lived 10th century, B.C. democracy derived, were originally "Aryans", both in terms of race, and in terms of the worship of Osiris. This is confirmed by the word "Israel", meaning "East-Sungod-Hare" ("Is-" = "east"; "-ra-" = "sun-god"; "El" = the Babylonian Saturn ["Sa-" = "sun"; "-turn" = "hare"]), related also to the Ural ("Hare-El") mountains, and Mt. Elbruz ("El's Burg" or "El's Mountain", in the Ukraine) a couple of the 'Aryan' ancestral regions.

The upshot of this tangled, mystical baggage, collected by various confused segments of the human race, is that "racio-religions" are one of the many excuses that "races" or "tribes" have used for exterminating one another, or even themselves, hi the Illuminati, we meet ourselves coming back, because both Hitler, the Austrian, and Einstein, the Jew, were members of it.

The Trilateral Commission (The "Three-Sided Commission", in reference to the triangle) IS the Illuminati. The triangle with the "all-seeing eye of God", is the triangular top of the pyramid with the eye, as seen on the dollar bill. It was used in the 1937 Los Alamos "p2" project, by von Braun. It is also a Masonic and Rosicrucian symbol. Originally, it was the eye of Ra-Bel or Ba'al (Ba' + El), the Sun God, and of Osiris, symbolized by the "Apis Bull at Memphis", with the sun disk on its head, which is the "golden calf mentioned in the Old Testament. Since the 'Osirian' Ba'alamites were still the religious leaders of so many of the Israelites, the Rabbis created a 'new' religion, in which the "old gods" were disavowed (or rather recreated in disguised new forms).

More specifically, the "modern Illuminati" is a secret group of world power mongers, whose title suggests that they are "illuminated" (i.e., possessed of some special or great "mystical secrets" or "wisdom of the ages", which we normal individuals do not possess). This is a bunch of crap, because David Rockefeller and his clique have no greater knowledge than you or I, except for the criminal knowledge that any gang of "Thuggees" have. The Illuminati have knowledge concerning the technological secrets which they have stolen and secreted away from the world, to maintain their dictatorship

by secret economic control, and to protect their secret resources from the threat of advanced technology which could free the people of the world from their control. This is not "higher" knowledge, but "lower knowledge".

Osiris ("The Beautiful Hare"), as a sun god, originally represented sunlight, and later "knowledge". This was reflected in Greece and Rome by Helios or Prometheus ("Pro-Mithraist") the "...bringer of light and knowledge...". To fundamentalist Christians, this was evil, because it was the same as Adam's eating of the apple, and "...partaking of the tree of knowledge...", which "...took away man's innocence..."(i.e., ignorance). The fact that an evil group calls itself "The Illuminated Ones", claiming "higher knowledge", does not make real knowledge evil, but good. That is what this book is all about. What is truly evil, is stealing and hiding technological knowledge created by individuals for the good of themselves and a civilized human race.

The evil "Set" (brother of Osiris) was obviously related to the origin and namesake for the Judeo-Christian "Satan" ("Sa-" = "sun"; "-tan" = "dawn"), which was synonymous to the Minoan Minotaur ("Min-" = "A-min" ["East-Min", or "Amon", the Memphis fertility goat-god], combined with "-taur" ["bull/hare"], to form a fertility goat-god/Apis Bull/Hare/sun-god which roamed about the Labyrinth, tormenting the damned sent there, beneath the isle of Thera ("She-hare", the Minoan name for "Ashera", a form of Astoreth, the female flying [Canaanite] form of Osiris). This was the derivation for the Christian "Purgatory". The "immaculate conception" of Christ, is similar to the ancient myth in which Isis (sister and wife of Osiris) "immaculately" conceived of Osiris, and gave birth to Horus, while Osiris was entrapped by Set in a knot in the trunk of a Tamarisk tree which was used as a roof support for the house of the King of Byblos. This ancient story originated in Western Siberia with the Uralo-Altaics, as a mating of the Sun-Hare, Osiris ("Heru-") and the Sun-Duck, Isis ("-Khuti"), giving birth to the Sun-Hawk, Horus ("Heru-Khuti", or "Hare-Duck"!).

George Bush and the rest of the Trilateralists would clearly like to force all of us to believe in their "god", whoever or whatever that is, and we are just no damned good unless we do. Again, the upshot of all this is that we're swimming in mythological garbage here, and we simply cannot allow ourselves or anyone else to predicate our political decisions on their personal, mystical, subjective religious concepts, and should settle only for government by reason, rather than a dictatorship based on "faith" in someone's personal or mass religious mythology.

The kind of thinking behind the Ahnenerbe/Nazi madness, could just as well have supported a movement by neo-Pagan "Aryans" (i.e., German Safartic {i.e., "Aryan"} Jews) to use a holocaust of their own making, based upon similar religious horse shit, as a pretext to "purify their race", by exterminating what they might have decided were "non-Semitic" Aryans, such as Gypsies, Khazars, Germans, or other Asiatic peoples who had converted to Judaism, rather than to have been born into it, via some of the "tribes" delineated by the post-Solomonic Rabbis, after the 10th century B.C. creation of the ancient kingdom of Israel. By such thinking, they could have exterminated the Christians, as "non-Semitic, heretical Jews". The prejudice of German Jews toward Asiatic Jews is well-known in some quarters, as reported by Meyer Levin (author of *Compulsion*, a true story about some murderers on a cross-country killing spree), during his promotion of *The Diary of Anne Frank*, when German Jews tried to take away the manuscript because Levin happened to be of Asiatic origin, and not pro-Communist.

The astonishing conclusion from all this, is that the modern Illuminati are a group of powerful and wealthy coercive monopolists—actually unfit and incompetent business men and industrialists—who sustain their power and wealth as a group, through theft of advanced technology, and concealment of it through mystical "mind control"-type manipulation of society. If known to the general public, this technology would break the coercive monopoly, and reduce things to the normal realm of capitalist competition and survival of the fittest. For this reason, this book is the greatest threat to Illuminati power ever seen, because it discloses the technological secrets and true origin of the flying saucer, as their best kept secret, and makes the construction of a flying saucer a possibility for anyone having competent technological skills, and wishing to build their own.

EINSTEIN WAS A NEW-AGER

The work of Albert Einstein is useful to the Trilateral Commission, not only for its fuzzy thinking, but also because of its support for the Big Bang, and other Big Lies of Big Science. Einstein was undoubtedly a great mathematician, but metaphysically and epistemologically, he was an idiot.

Einstein was philosophically an existentialist, religiously a Cabbalist, and epistemologically a Platonist. It is odd that the "Father of Existentialism", Edmund Husserl, had two main students, Jean-Paul Sartre, a Zionist, and Martin Heidegger, a Nazi. Einstein was a follower of the former, and Hitler was deified by the latter. Einstein's theories were influenced by the Kabalah as well as existentialism, which relies upon a Platonist epistemology—one based upon Plato's Cave Analogy, which holds that our knowledge of reality is like that of an observer in a cave, outside of which a caravan passes between a fire, also outside the cave, and a wall inside the cave, casting a shadow of the caravan on the wall; according to the analogy, we cannot know reality, but see only a "shadow" of it. In keeping with this cave analogy, Einstein continually referred to what he called an "apparent effect", as if his eyes and senses were unreliable tools of cognition, or means for acquisition of any valid facts about reality.

Einstein applied his peculiar existentialist and Platonist epistemological and metaphysical misconceptions to physics, thus protracting many cognitive mistakes into this supposedly "exact science". His fundamental errors included his fictitious concept of time, caused by his Platonist epistemology. The existence of what he referred to as a space-time continuum concept, was a begged question. He said that space is curved, attempting to attribute a geometric configuration or "grain" to unarticulated space. He was so subjective, that he thought what he called an "apparent effect" (his subjective manifestation of Plato's cave analogy), affected the whole universe, in a giant contradiction, based on the Platonist concept that man could not know reality or the nature of it, but only an "apparent effect" or "shadow" of it, which existentially had no relation to what anyone else knew or perceived. So why did he even bother to say it?

In reality, "Time" is a fiction created by man, to measure the rate at which events occur in the universe, and to interrelate them to each other within the spatial context on and around our earth, as it moves through space, and to measure cyclical movements having distinct relationships to all other events, particularly the movement of our planet in the solar system. A specific "time" is marked by a fictionalized, 'frozen moment' or position in space, in respect to a particular cyclical measurement of the clock and the

calendar—two mathematical computers used to measure "time". Our earth moves around the sun, while our solar system moves around our galaxy, which in turn moves around the edge of the Milky Way, which in turn moves around the outer reaches of the Magellanic Clouds. Our earth and everything on it, and everything else in the universe, can never be in the exact same place ever again. Any rational person should be able to see why "time travel" is a physical and metaphysical impossibility. But, if you can be tricked by the Illuminati into believing it is possible, then you can be tricked into believing any other Big Lie they arbitrarily choose to tell you.

In reality, we can know that, by the nature of reality, all events always occur in the instant present, and are irretrievably locked into their contexts in respect to all other events occurring at that same instant, throughout the universe, whether we are aware of them or not. References to "the future" or "the past" are purely fictitious, though we may reconstruct events as they occurred in the past intellectually. Single events cannot be displaced out of their contexts, without reference to their relationship to the rest of the universe at the time they occurred. 'Time travel' is also an epistemological impossibility, because a jump forward or backward in the fiction of "time", would require a physical jump of the whole universe from one configuration in one place, to another configuration, at a far distant place, instantly. This is too much to ask of the universe, just to satisfy the subjective, psychological whims of an Einstein. Only the present exists, forever, and reality is everything occurring or existing in that same, instant present, everywhere. We can know the nature of reality, without having to know all of its events and minute features.

Of the two epistemologies, the Illuminati propagate the Platonist one (and Einstein's theory of subjective 'time travel' and the 'forth dimension', etc.), because it supports the complete upheaval of a rational, Aristotelian epistemology based on the primacy of the senses as valid tools of cognition, and supports the mystical Platonist epistemology based on faith, which allows the public to be misled by, and to accept the Big Lie. The Big Bang cosmography is only a cosmological extension of this Big Lie.

The laws of physics are determined only by a true philosophically sound reasoning process. Einstein's fundamentally subjective and unsound reasoning errors were responsible for the wrongness of his theories, which could not be corrected by all his mathematical mumbo-jumbo. His peculiar metaphysical aberrations were manifested in his well-known formula, purporting to show the interconvertibility of "energy" and "mass", as follows: "E = MC²" ("Energy [the ability to do work] equals mass times the velocity of light, squared"). The formula 'equivocated' an abstract concept (the "ability to do work") with the manifestation of a physical concretion ("mass") multiplied times the velocity of light, squared. This was sort of like saying something like "work equals a rock times the velocity of light, squared." The formula doesn't say how much work can be done, or anything else, for that matter.

"Energy" E, is the "ability to do work", while the "velocity of light" ("C"), is the velocity at which electromagnetic radiation is said to be transmitted from one point in space to another. To equivocate the abstract concept of "energy", with mass times the square of the velocity of light, can be considered as of an attempt to explain how much work a particular mass might accomplish, measured by the quanta of radiation it might hypothetically be converted into, as a "non-inertial" form of dynamic energy stored in electromagnetic radiation in space, as well as a measure of how much potential electromagnetic energy is stored in a particular quantum of mass, but it just isn't true.

Einstein's contradictory theory presupposes that mass is not "energy", since, only during some non-spontaneous process of interconversion of mass into radiant energy, or radiant energy into mass, could "work be done". Mass appears impertinent, and " $C = E/R$ " (Tesla's equation, which excludes mass) appears true, saying that, at C , Energy E , is divided by resonant frequency R . 'Massless' radiant energy, or "cosmic radiation", is dynamic energy stored in transit in space, by the vibrations of the ether. I define space as a volume, which is never empty, but contains an ether, and omnidirectionally interpenetrating radiant energy, of many frequencies. The energy level of radiant energy is determined by its frequency. This radiant energy is the ZPR.

An interesting aspect of Tesla's equation, is that while the resonant frequency, R , divides the quanta of energy, E , at the velocity of light, C , the reactance of the electromagnetic radiation varies as the fourth power of the frequency; the higher the frequency, the higher the reactance. This means that " p^2 " is more effective at higher frequencies, since the time lag between changes in charge and current distribution in the dipole, is enhanced by the limitations of C . This permits the dipole to continue to "shake out" charges on the peak negative pole, both during and between negative peaks. At $3/8$ th wavelength tuning, the positive and negative wave components cross and neutralize one another at the neutral pole, between the negative peaks at the opposite pole. The principle that the negative pole will continuously shoot out negative charges is also effective at $1/4$ wavelength tuning, with the exception that the opposite pole will be peak positive rather than neutral.

Unlike Einstein, Tesla believed that the velocity of particles were not limited by C , and even advanced examples in which he asserted that particles had exceeded C , because the speed at which they were propelled by light depends on the voltage and frequency of the radiation. Mass or radiation in themselves do not represent "energy", since "work" requires the application of force to mass, which is ignored in the Einstein equation, but was automatically assumed by Tesla, who knew that space is full of potential energy.

The odd paradox under Einstein's theory is that radiation traveling through space would do no "work", and therefore could not be "energy". The only way light could be energy, would be if, as Einstein said, "it gets tired", in which case some of the force originally emitted at its source, is transferred to, and does work on, some of the 'space' (the ether) through which it is transmitted, but this case contradictorily requires the existence of something Einstein denied, the ether. His statement concerning "light fatigue" was inconsistent to his equation saying that 'space' has no mass, and thereby agreed with Tesla's equation, which was not plagued by this inconsistency, since it concerns only dynamic force in radiant form, as an "ability to do work".

Another major difference between Tesla and Einstein, was that Tesla conceived the so-called "atomic energy" possessed by an atom, as radiant force being transmitted into an "atomic reaction" by the cosmos. It may be for this reason that the "Tokamak" and other "fusion" reactors, using a "magnetic bottle" to contain their reactions, produce no net work. The extremely strong magnetic fields must create impenetrable barriers blocking reactions between the "atomic fuel", and the "outer cosmos" (i.e., occluding the ZPR). Like obsolete nuclear fission reactors, "fusion" reactors are intentionally designed as dangerous, behemoth structures, to be operated only by a corporate/state socialist ("competition-prohibited"), Trilateralist power company, providing little competitive threat to conventional hydrocarbon-fueled generators.

Einstein's equation excluded resonance, as the time-relative distribution of force in light per distance. The radiant energy stored in space is relative to voltage, which in turn relates to the frequency of the radiation, and the time it takes for it to be transmitted from its point of emission to its point of "reconversion" into inertia, momentum, or heat, or its expenditure on the ether, as it in turn is converted into mass. Mass has inertial characteristics which are not reflected, because the laws of inertia are said not to apply to electromagnetic radiation, which is 10^{40} times stronger than the gravitational interaction.

This implies that energy, like time, may not exist, but is only a convenient fiction, since inert, static mass does no work, and neither does radiation while in transit in space. The equations of Tesla and Einstein are in direct conflict, because Tesla's equation is consistent with the universe as a dynamic, ever-changing, eternal, infinite perpetual-motion system, while Einstein's equation describes the universe as a finite, temporary, Big Bang-type event, expanding from an ultimate, fictitious, 'original explosion', which is continually winding down. Of the two equations/metaphysics, the Illuminati naturally prefer the latter, since it supports their sales at the gas pump, and the suppression of flying saucer technology via their Big Lie Program.

Energy can only be expressed in reality, during "changes in form". Of the two equations, only Tesla's equation can be correct, since it is the only one taking resonance into account, which is the rate per second at which electromagnetic oscillations or "beats" occur. Without oscillations, nothing is converted in form. The frequency of electromagnetic radiation is the "beats per second", and the level of "force" or "voltage" at which work is done. The more beats per second, the greater the work. Before 1902, Tesla already had numerous patents for the use of "radiant energy", both from "synthetic sources" and from "the natural media" of the universe.

The Nazis and the Trilateralists stole Tesla's flying saucer invention, and the U.S. government helped them take it to Germany, and now conceal it from us. Nikola Tesla was an Atheist/humanist, who detested mysticism, Einstein, Communism, and the Nazis. Einstein's beliefs were consistent with the Nazis, Communists, Trilateralists, and the U.S. government. A naive Tesla tried to warn the U.S. government about German militarism before WW I, and was naturally ignored, because the Illuminati already had a big new war planned, and intended to make billions selling munitions. Meanwhile, Communism—an experiment in world slavery created by the Illuminati, as a mystical religion based on the worship of the "collective consciousness", accepted on faith rather than reason—came into existence, failed, and has finally collapsed, after murdering off literally hundreds of millions of people, in service to "Kali Ma". This shows how heinous, criminal conduct often originates with the Illuminati's appeal to "faith, rather than reason", as a means of mind control, inevitably followed by mass murder.

I have a dream that some day the United States will truly separate the "state" from "religion" and mysticism, whether that of the Illuminati, Christians, Masons, Buddhists, Bonpas, Moslems, Jews, Communists, New Agers, "Scientologists", "Environmentalists", or "Synergists".

In 1979, I went to the National Security Resources Study Center (now The J. Robert Oppenheimer Research Center), at Los Alamos, which was opened to the public in Oct., 1977 by President Jimmy Carter (whom I had met in Savannah, in October, 1974, during his campaign for governor of Georgia). I sought basic information on hydrogen, and could not find it, but what I did find was astounding. Though simple data on

hydrogen was 'unavailable', I discovered the plans for the hydrogen bomb! I also discovered the inadvertent "glossed" references to Lorentz' purported measurements concerning the excess positive charge of the hydrogen nuclear proton, and his postulate concerning the electrical cancellation of gravity. When I requested a "bibliography on Tesla" from the librarian, she said "...all information on Tesla is classified".

On my return to Santa Fe that evening, at a restaurant, I angrily proclaimed my disgust with the research facility, to a student from Harvard sitting next to me, for refusing my request for Tesla information, while making the plans for the hydrogen bomb available to me. The Harvard student went to Los Alamos, photo-copied the hydrogen bomb plans, and published a pamphlet on them at Harvard, creating a sizeable controversy. The center was almost since closed down.

Edward Teller, "Father of the H-Bomb", declared in 1979 that all secret information possessed by the government belonged to us, because we had paid for it, and that it should be made available to us from one year of the government's 'acquisition' of it. The H-bomb plans were probably intentionally planted by the Illuminati, to punish and scapegoat Teller, and to 'justify' increased "security measures", for the ulterior purpose of continued government suppression of other, beneficial energy secrets, having nothing to do with war or "terrorism".

Nikola Tesla originally intended to give his flying saucer invention to the Geneva Convention, for use in the prevention of war. He was disillusioned when the League of Nations fell apart, and began to conceal his discoveries. Tesla died a pauper in 1943, and the government illegally confiscated all his known papers. Today those scientific papers (over 80 large trunks, around a box car load), are stored in secret vaults at Los Alamos, still classified, over 56 years later. The main reason for the continued secrecy is the flying saucer, as well as things which we can only imagine.

In the end, the Illuminati perpetuate their power through mysticism, exploiting the interplay between Judaism, as the precursor to Christianity, and Christianity, as an heretical offshoot of Judaism. Naziism, an Illuminati "synthesis"—a slop-pot of the concepts of the Bonpas, Templars, Gnostics, Christians, Jews, and Mithraists—could never last, but accelerated the work of scientists working for the governments of the world, and produced a lot of discoveries in a very short time, for the Illuminati to steal and hide, or use to keep us in control.

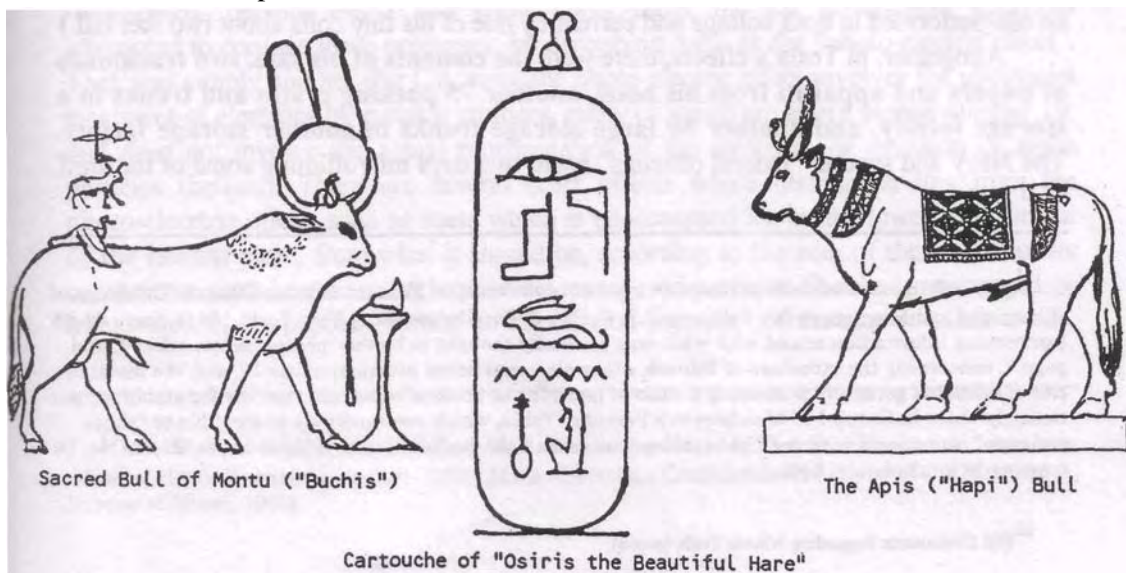

CHAPTER VIII: A TASTE OF OTHER ENERGY SECRETS

Part of the "social manipulation" of course involves the use of the mass media and instrumentalities of the state to suppress not only the flying saucer technology, but also other powerful technology. This small section is included to tantalize you with the possibilities of what I refer to as "suppressed energy secrets". There are many of them, and many more variations. This information is included to also give you a glimpse of the outright fraud of the "nuclear power" industry and the D.O.E. ("Department of Energy", formerly the A.E.C. or "Atomic Energy Commission"), and its concealment of viable and safe options to the monstrosities which they have foisted upon us, called "nuclear power generators", which represent a gross misuse of the principles involved, for which responsible scientists and engineers should be subjected to criminal fraud charges. The scientists themselves are bound by national security secrecy orders, the violation of which would subject them to criminal prosecution for treason or espionage.

To whet your appetite, please find APPENDIX B: Excerpts from Joseph Papp's Patent No. 3,670,494, of 6/20/72, Method and Means of Converting Atomic Energy into Utilizable Kinetic Energy.

Around 1980, I stumbled not to my surprise, upon more suppressed energy secrets¹¹. Most of this type of information hitherto publicly available, 'disappeared' from public access after 1942, due to the 'national scouring' operation by the F.B.I, which I mentioned before, which was not as complete as they would have liked. In fact, they missed some important material, due to their ignorance, being guided chiefly by the Relativist Quantum Mechanics, who failed to understand Tesla's technology. For example, on Tesla's death on Jan. 8 (not the 7th as most documents say), 1943, the FBI got involved in investigating as to whether or not anything of a national security interest was involved in Tesla's effects. In the opinion of John G. Trump¹², head of the government's Office of Scientific Research and Development, Technical Aids, Div. 14, NTRC (predecessor agency to the CIA's Office of Scientific Intelligence), "nothing of any value was contained", and there was "no reason to retain" custody of Tesla's effects. (Trump was also a professor at M.I.T., and had his feelings hurt by Tesla's 1938 review and critique of M.I.T.'s huge Van de Graaff generator~with its two thirty-foot towers and two 15-foot diameter balls, mounted on railroad tracks—which Tesla showed could be out-performed in both voltage and current by one of his tiny coils about two feet tall.)

Altogether, in Tesla's effects, there were the contents of his safe, two truckloads of papers and apparati from his hotel, another 75 packing crates and trunks in a storage facility, and another 80 large storage trunks in another storage facility. The Navy and several "federal officials" spent two days microfilming some of the stuff

¹¹This information initially surfaced in a set of books entitled Popular Science Library. The Story of Electricity and Magnetism (six volumes, P.F. Collier & Son Corporation, New York, 1941), pages 81-83 (concerning information mixed with what was generally thought to be the "photo-electric effect"), and page 7, concerning the structure of lithium, other elements below atomic number 19, and the instabilities of elements generally possessing a ratio of neutrons-to-protons which are "too low for stability", particularly those in Group I of Mendeleev's Periodic Table, which are especially susceptible to "photo emission", some even with red light (cesium), or green light (sodium), but all those below atomic No. 19 transmute in ultraviolet light.

¹²FBI Documents Regarding Nikola Tesla (supra).

at the Office of Alien Properties storage facility in 1943, and that was it, until Oct., 1945, soon after von Braun's residency at Ft. Bliss, Texas, at which time Wright-Patterson's Air Force Research and Development Command people took a closer look. They had all previously completely missed the boat in their attempts to interpret Tesla's technology—according to the false Relativist physics—mainly because of the snotty report by their "expert", John G. Trump. Even the FBI has failed to grasp the significance of the note concerning Ms. Marguerite Merrington's witnessing of Tesla's 1894 "metallic plate suspension", and to black it out, in the Tesla papers released under the F.O.I.A. It wasn't until von Braun and company disclosed that their flying saucer technology was based on Tesla's 1890s discoveries, that our government knew what they had, and what the Nazis had already acquired in the 1930's from Tesla's files. Quite a lot of Tesla's technology had already leaked through several sources before the FBI's scanty look into it in 1943, fully seven years after von Braun's "p2" project at Los Alamos.

Practically the only thing they were looking for was technology related to the atom bomb, and since Tesla had stated that so-called "atomic energy" didn't come from the radioactive elements themselves, but from "cosmic radiation", they decided he was crazy and neglected his documents until the war was over. This concealment by neglect was the apparent result of Nazi/corporate-state influence in the government and F.B.I.

The data I found around 1980, which showed that all the elements below atomic No. 19, actually transmute in ultraviolet light—some in ordinary daylight—conflicted with Relativistic Quantum Mechanics. The products of these light-element transmutations, brought about with low energy bombardment, are alpha particles (stripped helium nuclei, each carrying a +2 charge), and beta particles (electrons, each carrying a -1 charge). On purchasing at Los Alamos salvage, two withdrawn volumes on the physics of X-rays¹³. These books showed the existence of the transmutation process. I realized that this information and all its reasonably construed implications, had been known by some scientists in both the U.S. and Soviet governments for years. These concealments apparently had nothing to do with "national security", and the two "governments" were apparently in conspiracy to protract archaic technology. Some governments, huh?

Due to prior public access to these secrets, and the possibility that some 'uninitiated' persons might still know about them, the liar government scientists attempted to confuse these processes, by describing them as the "photo-electric effect". That was simply another Big Lie, since the photo-electric effect involves the ultraviolet ejection of electrons by suitable emitters, many of which are above atomic number 19, and does not involve the actual transmutation of the elements, or emission of alpha particles (helium). There are several other effects which distinguish this from the photo-electric effect, such as mass which is unaccounted for by the lower total weight of the helium atom, from what it should be, according to the sum of the weight of its component parts, representing equivalent energy or particles liberated, rearranged or transmuted in the process, similar to the "fusion reaction" of the sun. In other words,

¹³M.A. Blokhin, *The Physics of X-Rays* (State Publishing House of Technical-Theoretical Literature, Moscow 1957); Howard M. Stainer, *X-Ray Mass Absorption Coefficients* (U.S. Dept. of the Interior, Bureau of Mines, 1963).

this simple process can release or absorb (the same difference) the energy equivalent of the fusion reaction, in an externally reversible "K-capture" process, in which a K-orbital electron of an appropriate element "falls" into the nucleus (is "captured"), converting a proton into a neutron, transmuting the element into one with one more neutron in the place of the former proton. It is my theory that ZPR and aether-borne energy contained in the space encompassed by the electron prior to its capture, results in the emissions observed, which are "squeezed out" when the electron is captured by the nucleus.

In this process, neutrinos are emitted as the element goes up the atomic scale, and are sucked back into the atom as it returns to its former element, over and over, if the process is continued, in a sort of "continuous nuclear orgasm". Here, we have another "table-top"-type fusion reaction, which has been concealed, primarily by treating it as an insignificant 'anomaly', which is then avoided and summarily dismissed.

A similar process occurs in nuclear excitation of a light element, in which an electron orbit is distorted by a magnetic field, or is excited a by a U.V. incident particle beam, and repeatedly becomes excentric, so as to "gather" energy in the "L" orbit, then emit it in the form of ionizing radiation, as the electron "falls" back into the "K" orbit. This process requires a carefully synchronized and controlled excitation at the specific NMR frequency of the element, under a specific magnetic flux density.

I soon realized that most of the "free energy" processes can be produced by using a medium in a "box", to transform electromagnetic power from the ZPR. Based on these processes, I developed the idea of what I call my "Triax ("three-axis") System", composed of three axes at 90 degrees to each other, which are: (1) The magnetic field axis; (2) the electric field axis; and (3) the particle beam axis (or "atomic axis", which may also be considered as the "momentum axis" in respect to its use in flying saucer propulsion). Any two of the axes may be used to produce the third, as follows:

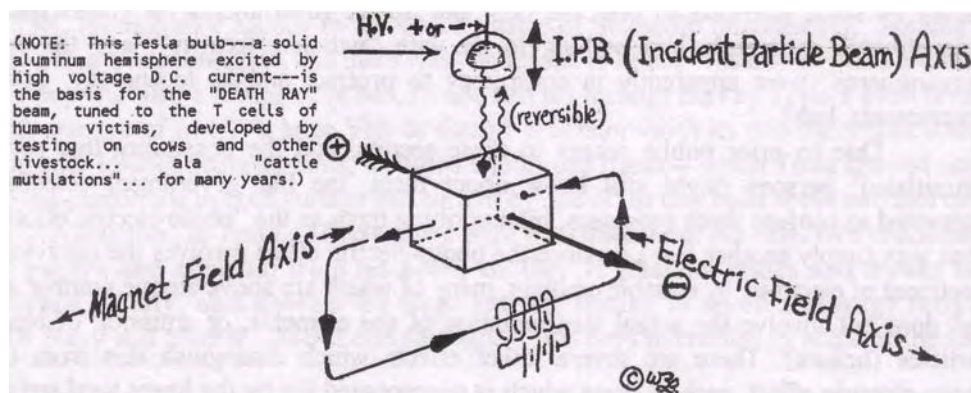

A magnetic field will separate positive and negative charges, by turning negative charges in one direction, as positive charges are diverted or emitted in another direction (negative charges may be easily turned, while the positive charges are very difficult to turn). The charges may be collected on separate plates, to create an external current, and vice-versa. The incident particle beam directed at a sample of one of the light elements

or a compound of them (often better), placed in a "triax box" with a magnetic field across it, causes the manufacture of positive and negative charges. The positive (alpha) particles charge the first plate, while the negative electrons pass into the second plate, being drawn into the circuit by the positive potential of the first plate—created by the presence of the positively charged alpha particles—and are drawn through an external circuit load, to perform work. These particles may be steadily recycled in an oscillatory fluorescent process which may be continued ad infinitum, so long as the load placed on the external circuit is not dropped too rapidly.

The trick is to transmute an element into a temporarily radioactive isotope of very short half-life, after which it quickly returns to its ground state, with the emission of photon energy extracted during its synthetically radioactive reaction with the ZPR:

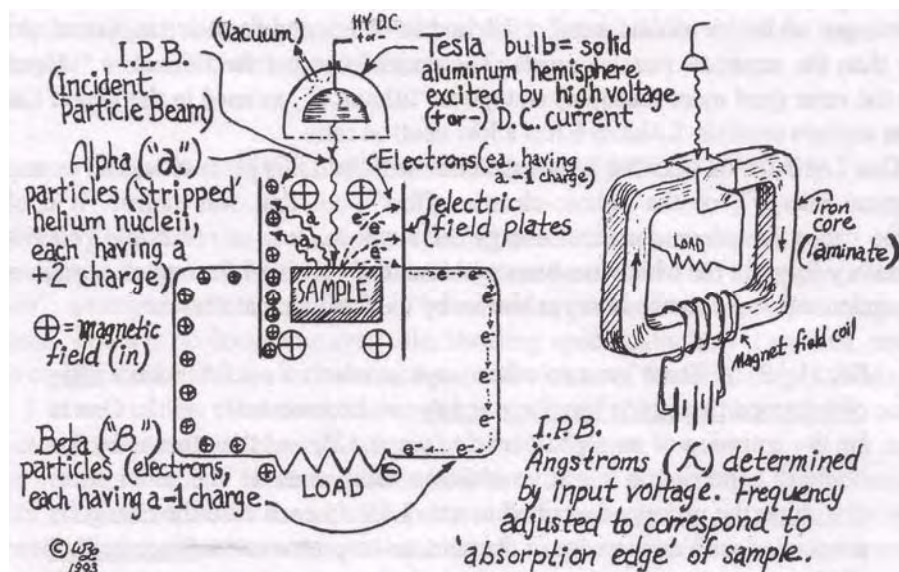

Using a one-mole sample of lithium 6—or lithium niobate crystals, manufactured by Union Carbide—this process will produce a continuous external current of 50 kw, indefinitely, unless the load is dropped too quickly, in which case a small explosion can occur. This can be 'fail-safed' by use of a computerized control of the incident particle beam in respect to the load, in conjunction with an appropriate device such as an ultraviolet laser. More simply, an incident particle beam device can be easily fabricated using the Tesla bulb shown, which may be controlled with an FET (field effect transistor), which senses a change in the field strength and instantly diminishes the current to the bulb.

Lithium is the most active of all elements, and is perhaps the most unstable of the "light elements". In some cases, transmutation can occur in an incident particle beam of less than 7 volts according to the Blokhin book (in the bibliography, and many other

similar X-ray references), which gives specific product emissions for most elements (unless "classified") in respect to the frequency of an incident particle beam used at specific voltages. Powerful ionizing radiation can be used to charge field plates, or to produce 'pure electrical energy". The energy produced, is vastly greater than the electrical energy required to initiate the reaction, because it comes from the ZPR ("starlight"), and need involve no radioactive fuels or wastes.

These processes were explored by Tesla prior to 1900, and by T. Henry Moray, of Utah¹⁴, while in Sweden in 1912. Tesla used aluminum and some Group I elements, while Moray used spudomene or lepidolite—lithium-aluminosilicate rocks—which he called his "Swedish stone", to which he soldered triple-distilled germanium, producing semiconductor devices (which he called "valves") almost twenty years before Shockley, who got the credit. These rocks are almost everywhere in Northern New Mexico, especially found in pegmatite dikes. Shepherders in the vicinity of Dixon (where the government mined lithium for the H-bomb), carried pieces of lithium ore in their pockets in winter, to warm their hands. The moist hands provided the electrolyte contact, and penetrating cosmic radiation (the ZPR) did the rest. The lithium-aluminosilicate elements are all below atomic number 19, and in compound form are supposed to work better than the separate, pure elements. The normal number for lithium is "lithium 7", while the rarer (and more unstable) isotope is "lithium 6", as used in the Union Carbide lithium niobate crystals. Lithium 6 has a low neutron ratio.

One Los Alamos scientist I discussed this with said this process was an example of "chemical energy", or the "photo-electric effect", but that was untrue. It could be perhaps called "nuclear chemical energy", I suppose. It is a reversible process, the explanatory formula for which has been systematically omitted from nuclear engineering texts, under national security laws, as shown by the following statement:

Sec. 1.19: "...There are two other ways in which a nuclide with a ratio of neutrons that is too low for stability can become more stable. One is by the emission of an alpha particle (sec. 1.12), and the other is by the nucleus capturing a negative electron from outside the atom, thus reversing the process described in sec. 1.16. In each case the change is associated with an increase in the neutron-to-proton ratio. Since neither of these modes of radioactive decay is important in connection with nuclear reactors, it is unnecessary to consider them in further detail."¹⁵

And so, two separate possible "other" ways to produce atomic energy—both using non-radioactive light elements—are concealed. The primary justification for the concealment of these two processes is rationalized (for over forty years, since 1952 or earlier) because they are possibly being used to generate electrical energy on flying saucers and other secret projects. Although the processes are allegedly unimportant "...in connection with (archaic) nuclear reactors" of the kind desired by the Secret Government,

¹⁴ T. Henry Moray, *The Sea of Energy in Which the Earth Floats*, Cosray Research Institute, Salt Lake City, Utah (4th Ed

¹⁵ Samuel Glasstone and Milton C. Edlund, *The Elements of Nuclear Reactor Theory*. D. Van Nostrand Co. Inc., Princeton, 1952 (emphasis mine).

protected by the sham A.E.C./D.O.E. cover, it is obvious that the use of these concealed processes might literally destroy the obsolete petroleum and atomic energy industries as we know them today.

These two (reversible) processes, combined in the continuous, oscillatory reaction, appear to be the same as that responsible for the helium power system already mentioned in respect to the helium-powered "...twelve B.M.W. engines..." purportedly used on WW II German flying saucers, and in respect to the Papp engine shown in the Appendix.

Can you imagine carrying one of these little generators around in your hand, from your house to your car, airplane (flying saucer), boat, or on camping trips, etc., to provide whatever, non-polluting electrical energy you wished, more than you could probably use?

It comes clearly into focus at this point, that the culprit vested interests are in the petroleum industry, or rather in the Wall Street monopolists who took over almost all independent petroleum production in the 1950s. I say this even though I could stand to inherit many thousands of acres of proven gas and oil mineral rights in southeast Texas. Since the Trilateral Commission or Masonic crooks within my own family will probably rip off those mineral rights somehow, before I inherit them, and obliterate all evidence, I probably won't get them anyway, so why should I care? What is more important, is replacing this archaic technology with "free energy" generators.

TESLA'S 'SPECIAL' GENERATOR: HOW DOES IT WORK?

Nikola Tesla discovered a simple, 'special' generator—the complete secret of which is locked away in the Los Alamos vault—which was constructed of "...copper, aluminum, and iron", arranged in "...a peculiar way", and had weak magnets or only unmagnetized iron cases. There is no document available, showing specifically how it worked, and only Tesla's cryptic comments on its construction, with claims of fantastic output. The closest things I know of are Tesla's homeopolar generators. Judging from them, and his invention of the standard electric meter used by the power companies on our homes, together with some actual experimentation and tests, I have extrapolated the fundamentals of Tesla's invention, since the electric meters are constructed in a 'peculiar' way, are composed of the three metals, and have weak magnets which can be reversed and 'oscillated'.

In 1979, I took two old 115-volt Tesla electric meters—which are at least 70 years old—and connected them together in a 'peculiar way', attempting at first to measure two separate 115-volt currents coming into an apartment. There are four unlabelled posts on each these old meters, so I didn't know how to connect them, so I just took a shot in the dark. Due to the manner in which I connected them—which apparently was wrong—the two meters behaved strangely. At a low current drain, the disks rotated faster than when the current was greater. At a sufficiently high current, the disks stopped, hummed loudly—which I refer to as "snoring"—and even reversed, at a still greater energy consumption in the apartment. As the current usage went up and down, there were commensurate changes in the "snoring" and disk directions in the two meters.

By actually using more electricity in the apartment, less usage was recorded by the meters, as well as the main meter for my entire complex, and the electric bill for my whole complex dropped by about one-third. The meters were generating power, perhaps enough to power the entire apartment. Sometimes, when the disks were running in reverse, the

meters were generating more power than that being used, and when they were running slowly in the opposite direction, the meters were generating less, but overall, the one-third drop in the bill indicated they were running that apartment, one-third of my complex.

Mr. Dort—the Virginia man whose father invented the special generators stolen by the Nazis and used on their "Electro-U-boats"—said that, when the 'snoring' was at its peak and the disk stationary, that the meter was at the "center of load", which meant that the amount of current being used was equal to that being generated by the meters! When the disks reversed, the 'meters' were generating more current than that being used, and were putting electricity back into the grid! After I removed the old meters from the circuits, my bill increased by one-third. By that standard, I may have been able to reduce the usage to practically zero, by connecting meters the same way in the other three residences, or by running all my current through the meters.

Under the generally accepted theory of electric power generation (inductance), a magnetic field and conductor are required. A dynamic conductor must 'cut' stationary magnetic 'lines of force', or dynamic 'lines of force' must expand and contract across a stationary conductor, to create the cutting action necessary to produce current in the conductor. Since energy is expended by use of alternating current to create an expanding and contracting magnetic field, the use of permanent magnets—which require no current to create their fields—is considered most efficient, except where it is desirable to have a reversing magnetic field in the core. The Tesla electric meter has weak magnets, which Tesla said was necessary so the magnetic fields could be reversed and alternated. The meter wouldn't work if it had very strong, completely polarized magnets. There are two basic ways the Tesla 'meter' can be used as a generator, as far as I can tell:

1. Mechanical: The disk may be rotated in the weak permanent magnet field, by a small motor connected to the shaft of the aluminum disk, generating an electric current in the disk. The current rises until sufficient to cancel the magnetic field, which it then reverses, as the current in the disk collapses and reverses, due to the reversed magnetic field, and the system begins to oscillate. An alternating output current is induced in the windings of the two sets of pole-pieces which are above and below the gap in which the disk rotates.

2. Electromagnetic: With this method, the current is run parallel through the windings of the pole pieces of two separate meters, creating a magnetic flux which alternately passes through the disk, and into the lower pole pieces, creating a current at right angles in the disk, which creates a thrust which rotates the disk in the weak magnetic field of the permanent magnets. When the current in the disk is sufficient to cancel the weak permanent magnetic fields, the disk stops, then "vibrates" ("snores"), as it rapidly and alternately reflects and transmits both the current and the magnetic fields, producing an output alternating current in the pole piece windings.

According to Mr. Dort, aluminum is the best "reflector", copper the "most active" (electronically conductive), and iron the "magnetic core material". Dort said his father's magnetic drive was based on a Tesla generator. Based on the drive system stolen from Dort's father by the Nazis, and used on the Electro-U Boats, Grand Admiral Karl Doenitz promised Hitler a "miracle at sea". How did the Tesla generator work?

The particular Tesla generator used by Dort's father—and the Nazis—was one which was being developed by Tesla in 1895, in conjunction with his developments concerning the liquifaction of air. Tesla knew, from Lord Kelvin's discoveries, that more heat is

absorbed by liquified air when it is re-gasified and used to drive something, than is required by theory, in other words, that the liquifaction process is somewhat anomalous or 'over unity'¹⁶. Just prior to Tesla's completion of his work, and the filing of a patent application, Tesla's laboratory was burned down, destroying all his equipment, models and inventions. Immediately after the fire, Linde, in Germany, filed 'his' patent application for the exact same process, which recombined some of the heat energy produced in compression of the air, to drive the process, just as Tesla had done.

Tesla had combined the liquified air process, with his pneumatic piston-driven oscillator, even prior to the fire and Linde's patent application. In addition, he had calculated that, for every 200 pounds of iron connected to the device, a full horsepower was added to it. Can you imagine how many horsepower were added by the connection of the oscillator and liquifaction device to the body of a submarine? If hypothetically a Type XXI German submarine were retro-fitted with this oscillator, and its displacement were 2,700 tons, that would produce an extra 27,000 h.p., only a small part of which would be needed to drive the oscillator, which involved very little friction and force to produce a large current.

The Tesla oscillator developed by Dort's father, used on the Nazi Electro-U-Boats, is shown in my following simplified, clarified illustrations, based on Tesla's originals:

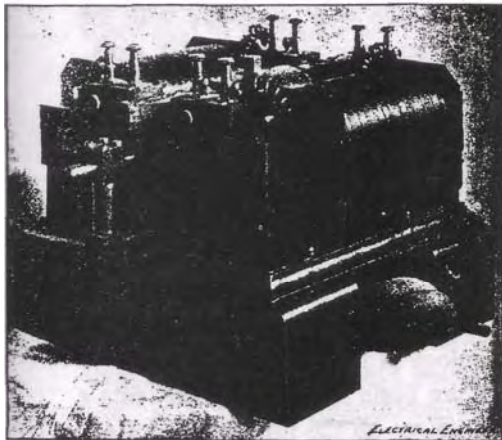

At the left is a photo of Tesla's earlier oscillator, which was unfortunately destroyed by fire in 1895. Projecting at its bottom right is a tube for connection of the compressed air line. Across the top are electrical posts to carry exciting current to the windings (around the outside), and from which generated power is extracted.

To the right is a schematic of the oscillator. **M** is the laminated iron core. **H/H** are the gaps in which the two small inductors on the shaft vibrate, cutting magnetic lines of force crossing the gaps. The square enclosed mechanism in center is the air-powered mechanical oscillator which drives the horizontal shaft. **B/B** are the shaft bearings.

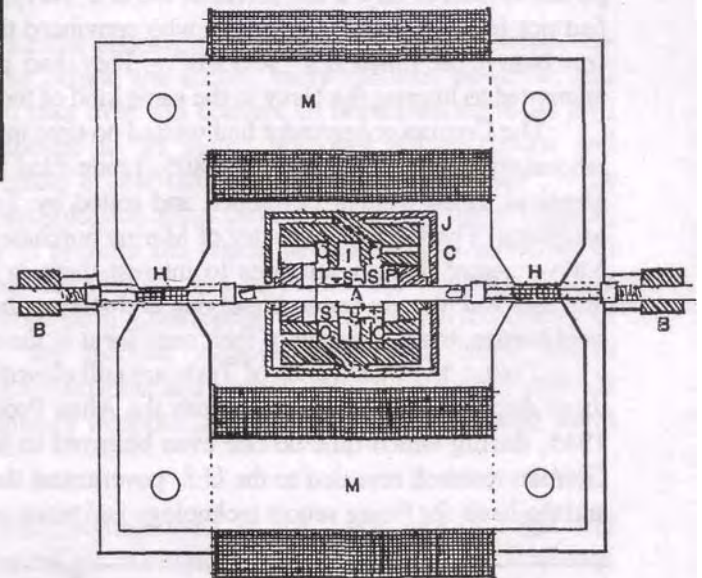

¹⁶ Nikola Tesla, Startling Prediction of the World's Greatest Living Scientist (Article, the North American, May 18, 1902).

The inductor-shaft of this oscillator was driven by the small pneumatic piston, powered by the liquid air. The shaft needed to vibrate only about 1/16 inch, producing a mere 'hum', which Tesla said was capable of vibrating a system of considerable weight "...many thousands of times per minute"¹⁷ (standard 60 cps would be 3,600 times per minute). It is assumed that the increased horsepower from the iron of the sub, was combined thermodynamic energy added to drive the liquifier, as well as energy received by the oscillator from the same ELF transmitter which could also send messages. The iron could maintain the flow of heat liberated from the air as it was being compressed and cooled, and from the iron where it was stored, back to the air (in a Carnot cycle) when being expanded to drive the piston. At the same time, the iron could act as an antenna to receive earth's electrical energy being regulated by the 'transmitter' at a distance, electrical energy of stationary waves traversing the earth from pole to pole, as finally confirmed by Tesla during his 1899 Colorado Springs experiments. The iron collected electromagnetic energy from the earth system to be added to the electrical power of the oscillator as it was driving an Electro-U-Boat's motors and charging batteries. As stated by Tesla in 1898¹⁸, (in pertinent part): "Primarily, I contemplated only the sending of messages to great distances in this manner." "Now, this idea I extended to a system of power transmission."

The windings on the oscillator were about 50 miles in length, and its inductive-capacitive system allowed it to operate on a frequency which was consistent with the earth's, at a wavelength of about 925 miles, with a frequency close to 13.5 c.p.s., sometimes mentioned in relation to Naval ELF communications. Was this part of Tesla's long wave system for "transmission of electric energy without wires", which he said he had completed just prior to his death, as shown in the FBI documents? Is the Navy's ELF ("Extremely Low Frequencies") system not only for communications, just as Tesla said, but also for broadcasting energy to submarines—just as Tesla also said? This submarine power system is now a top secret of the U.S. Navy. They could have had in 1943 if they had not listened to their "experts", who convinced them Tesla was crazy, something they can blame on Einstein's "R.Q.Ms". They had paid no attention to Tesla when he attempted to interest the Navy in the same kind of technology in 1901¹⁹.

The German government had wasted no time in taking Tesla seriously. When Tesla's laboratory was burned down in 1895, Linde filed his patent on the liquefaction of air, identical to the system developed and tested by Tesla in conjunction with running his oscillator. The German Ministry of Marine purchased Tesla's turbine right after the U.S. Navy rejected Tesla's attempts to interest them in it first. By 1905, German chemical interests had already begun liquefying and storing thousands of gallons of liquefied air in steel bottles, in anticipation of their need for it in the coming submarine warfare.

Today, the discoveries of Tesla are still classified, over 56 years after his death, yet these discoveries laid in storage with the Alien Properties Custodian between 1943 and 1945, during which time no one even bothered to take a look, until after the war, when German research revealed to the U.S. government that Tesla's discoveries were valuable, and the basis for flying saucer technology and many other still classified developments.

¹⁷ Patent for Tesla's Valvular Conduit, No. 1,329,559, Feb. 3, 1920.

¹⁸The Sun, New York, Nov. 21, 1898.

¹⁹The Transmission of Electrical Energy Without Wires As a Means for Furthering Peace, Nikola Tesla, ELECTRICAL WORLD AND ENGINEER, Jan. 7, 1905.

CONCLUSION

In his original foundations for the Bavarian Illuminati, officially instituted by Adam Weishaupt on May 1, 1776, his stated purposes were good:

"Princes and nations will disappear...
Reason will be the only code of man. "

Weishaupt recognized no divine power outside of Man, and often referred to "...Nature and Nature's God".

The original purposes of the Declaration of Independence stated by Thomas Jefferson and other American revolutionaries, on July 4, 1776—only two months after Weishaupt's declaration—were good, also referring to "...Nature and Nature's God", just as Weishaupt had done.

The original purposes of Michael Bakunin, in the founding of his Internationale (the Alliance Internationale Sociale Democratique), in Switzerland, in 1864, was good...seeking an instrument to destroy the tyranny of the confiscatory state, and motivated by a genuine horror of his own experiences under despotism.

The original purposes of Theodor Hertzl, in calling together the first International Zionist Congress, of March, 1897, in Basle, Switzerland, were good, advocating that "...sovereignty be granted us over a portion of the globe large enough to satisfy the rightful requirements of a nation," intended by Hertzl to be guided by the individualistic premises of Friedrich Nietzsche.

The problem with these and similar endeavors, is that the Pseudo-Illuminati—by whatever name we know of it—lurks behind the scenes, more ruthless, powerful, and thorough than ever, always poised to take over and convert all organizations to its own use, in a manner diametrically opposite to its stated purposes. Organizations and movements originally intended to create a new religion of "reason and nature", were converted into ones for the mass psychological mind control of society, using religion, political mysticism and superstition to prohibit the higher development of mankind, to conceal technology, truth and higher knowledge, and to create and maintain a false economic dependence on Illuminati-controlled governments and the archaic technology of Illuminati industries. Meanwhile, the medical establishments and world health organizations are controlled and used to distribute and conceal population control methods developed and expedited by secret military weapons laboratories, so as to maintain world populations at "controllable levels".

The Illuminati, hypocritically styling itself as the "...Bringer of Light and Knowledge...", preys upon the sincere beliefs of religious people, and promotes irrational, mystical, superstitious or exploitative ideas or means, contrary to what might have been initially good purposes, showing the consciously designed, sociopathic conspiracy to control the world through deceitfully planned ignorance, mysticism, dependency, and the promotion and exploitation of weakness.

Philosophy—the "master control" of rational scientific thinking—has its "first laws"...irreducible primaries which must first be accepted by presupposition, before further rational thought may proceed. These first laws must rest on the facts of reality, before we can reach other reliable conclusions, such as that involving a possible 'origin'...if there was an origin...of the universe. This question was first begged in religious 'creationist' myths of the most infantile sort, just as UFOlogists begged the question that flying saucers are extraterrestrial. A god in the image of man, space aliens in the image of man, and 'extraterrestrial' flying saucers in the image of man-made flying saucers. On the issues of God, the Big Bang, Space Aliens, and Flying Saucers, rational people have been crowded into a corner as the 'nut cases', defending the "irrational" positions of the nonexistence of God, the infinity of the universe, the absence of evidence of aliens, and the terrestrial origins of flying saucers. That time has now ended. The Big Liars can prevail only by exerting absolute control over the press, public speech, and the media. They are now frantically multiplying their redundant Tired Old Big Lies in the public media.

The Illuminati eventually came to secretly advocate the use of unethical and murderous methods by its members, to cause unnecessary struggle and conflict of every kind, and to exploit mystical religious or political organizations, racial concentrationism, and military nationalism, in order to set up conflicts needed to create constant chaos and instability, in the midst of which they maintain and increase their wealth and economic control.

The Jesuit and Masonic orders fell to Illuminati control, as did Bakunin's Anarchist Internationale (expropriated by Marx and his Communists). The American Government fell to Illuminati control, via exploitation of the conveniently covert natures of the CIA, FBI, NSA, the Masonic Order, the Jesuits, the Trilateral Commission, the Council on Foreign Relations, and the Bilderberg group.

After the 1919 failure of "Morgenthau's Pastoral Policy" to exterminate the "German race", at the end of WW I, the S.S. was formed later that same year, as an experiment in mass psychological control, financed by the World Bankers, the Rockefeller Commission (now the Trilateral Commission), acting through the S.S., under the auspices of the Hogg Foundation for Mental Health and "Eugenics Program" of the University of Texas, and the American Psychiatric Association. Their purpose was the control of the world through religion. To this end, a new religion, called "OSTARA"—'designed' by Georg Lanz von Liebenfels—was promoted through the S.S. and the Thule Society. This new Nazi religion used ancient religious mythology as its basis, falsely depicting the 'gods' as "aliens". For example, the Egyptian God of Darkness, Apepi (Apothis), a serpent, was claimed to be a "reptilian alien god" which lived under the Great Pyramid at Giza.

In the mass-psychology experiment, the Nazi alien religion was used to stretch the credulity of the German people, so they would believe whatever Big Lies their government told them. It was decided in 1923 that Adolf Hitler was to lead the German people in this experiment, to culminate in a mass suicide of the German people, in a "Wagnerian tragedy", then to fake his own suicide and make his secret exit. After the fall of Germany,

and "destruction of the weak", the Illuminati "New World Order" was to come into being in 1945, as the United Nations.

Hitler handed over the flying saucer secrets to his benefactors in the Trilateral Commission, in a secret deal cut between the World Bankers and Industrialists, Trilateralists, CFR, Rockefellers and the Nazis, with the U. S. government acting as "security guard." The Nazi alien religion has since been promoted covertly by the U. S. government to conceal the flying saucer secrets, so that "UFOs" can be depicted as "alien technology", and kept from the people.

With the fall of the Soviet State, the U.S. political leadership soon began to bully and officiously intermeddle into the affairs of smaller, troubled, disadvantaged countries. Wars, pseudo-justified as "humanitarianism", are incredibly lucrative for IllumiNazi war industries. In March, 1999, through NATO, the U.S. began bombing Serbia, ostensibly to "save the (Muslim)ethnic Albanians from the atrocities of (Orthodox Christian) Serbians", following an undisclosed agenda to establish the authority of a "New World Order", which I call InterNaziism, disguised as humanitarianism. After the French Revolution of 1789, Robbespierre became known as "the humanitarian with a guillotine," in a "reign of terror". An "humanitarian with laser-guided bombs" is no less a terrorist, and has no business sticking the American nose into an ancient, foreign religious squabble, using this "wedge" as a pretext to establish world InterNazi authority.

The mainstay of the IllumiNazis are their monopoly of energy, minerals, raw materials, war materiel and military weaponry, related technology, and the media and communications industries through which they control information. The flying saucer represents their single most important technology, the continued secrecy of which is indispensable to the maintenance of Illuminati world control, because of its incredible fuel efficiency, speed, and electrical performance characteristics—all of which conveniently make the hoax more convincing—which mandates a priority of utmost urgency, to be pursued by them "at all costs". That is the reason these secrets have thus far remained concealed behind the Nazi "alien" religion. Meanwhile, our physicists and aeronautical engineers stand idly by in their dumb government jobs with their thumbs up their butts, awaiting their next checks.

The exact same Nazi alien religion is being promoted covertly today by the U. S. government and the Illuminati, through fancy, well-financed TV productions, books, movies, UFOlogy and New Age groups, which spread the lie that flying saucers are "extraterrestrial", to serve the dual purpose of concealing flying saucer technology and hypnotizing the American masses. We have an InterNazi government.

IN THE NAME OF THE FREEDOM-LOVING PEOPLES OF THE WORLD, I
HEREBY TAKE BACK THE FLYING SAUCER SECRETS THE ILLUMINATI STOLE
FROM US, SO THAT WE MAY LIBERATE OURSELVES FROM THE ILLUMINATI,
AND CREATE A PROSPEROUS NEW FREE WORLD CIVILIZATION, BASED ON THE
CREATIVE PROCESS, INDIVIDUALITY, PEACEFUL LIFESTYLES, FREE TRADE,
FREE TRA VEL, AND LITTLE OR NO GOVERNMENT

ALIENS289

BIBLIOGRAPHY

ELECTRICITY, MAGNETISM AND WAVES

R. L. Armstrong and J.D. King, The Electromagnetic Interaction, Prentice-Hall, Inc., Englewood Cliffs, N. J.

U. S. Army Research and Development Laboratories, Image Intensifier Symposium, Oct. 6-7, 1958, Corp of Engineers, Warfare Division Branch

Bethge, O., Kleen, Werner, Translations from Annalen der Physik (1931)

Edwin H. Hall, Amer. Jour. Math. ii (1879), p. 287

D. E. Jones (translator), Hertz' Electric Waves, p. 29

Langmuir, Physik. Z., 14 1273 (1913)

John R. Pierce, Electrons and Waves, Doubleday & Company, Inc., Garden City, New York

H. A. Rowland, Ann. D. Phys., clviii (1876), p. 487

J. J. Thomson, Phil. Mag. xxxi (1891), p. 149

J. J. Thomson, Recent Researches in Electricity and Magnetism (1893), p. 13

Zeiten Schrift. (1994), p. 64

ELECTRO-PROPULSION, ETHER PHYSICS AND RELATIVISM

Hannes Alfvén, Existence of Electromagnetic Hydrodynamic Waves, Nature, vol. 150 (Oct. 3, 1942), pp. 405-6.

Beckman Instruments, Inc., Hall Effect Manual, Helipot Division, Fullerton, Ca.

Arthur C. Clarke, Electromagnetic Launching as a Major Contribution to Space Flight, J. Brit. Interplanetary Soc., Vol. 9, 1950, pp. 261-67

Barnard Ebershaw, Antigravity Propulsion Devices, R. & D. Associates, Inc., P. O. Box 873, Concord, N. C. 28025

Michael Faraday, On the Possible Relation of Gravity to Electricity, Britannica Great Books, Vol. 45, pp. 670-73

R. A. Ford, The Perpetual Motion Mystery, Lost Technology Series, Reprinted by: Lindsay Publications, Inc., Bradley, Illinois (1987)

George Gamow, Gravity, Doubleday & Co., Inc., N.Y.

George Gamow, Thirty Years that Shook Physics, Doubleday & Co., Inc., Garden City, N. Y.

Paul R. Hill, Unconventional Flying Objects, Hampton Road Publishing Co. (1995)

Dr. Franklin Kilpatrick, Free Energy Secrets!

Carl Frederick Krafft, The Ether Vortices, Borderland Sciences, Garberville, Ca (1987)

Carl Frederick Krafft, The Structure of the Atom, Borderland Sciences, Garberville, Ca (1987)

R. E. Lapp and H. L. Andrews, Nuclear Radiation Physics, Prentice-Hall, Inc., N. Y. (1950)

Eric Lerner, The Big Bang Never Happened, Random House (1991)

William R. Lyne, Occult Ether Physics, Creatopia Productions, Lamy, New Mexico 87540, (1997, 1999)

John-Erik Persson, About an Alternative to the Lorentz-Transformation (Hägersten, Sweden, 1997)

Gary Taubes, Relativists in Orbit, Discover (Mar. 1997)

J. A. Wheeler, Geometrodynamics, Academic Press (1962)

Sir Edmund Whittaker, A History of the Theories of Aether and Electricity (Revised and enlarged edition, 1951) Thomas Nelson and Sons, Edinborough

ION PHYSICS, RADIANT ENERGY, AND ARTIFICIAL RADIOACTIVITY

M. A. Blokhin, The Physics of X-Rays, State Publishing House of Technical-Theoretical Literature, Moscow, (1957), Reprinted by U. S. Atomic Energy Commission, Office of Technical Information.

G. Breit, M. A. Tuve and O. Dahl, A Laboratory Method of Producing High Potentials, Dept. Of Terrestrial Magnetism, Carnegie Inst., of Washington (published in PHYSICAL REVIEW, Vol. 35, 1930).

Dr. Sam Cohen, (Red Mercury), America Online: DJIBO, (3/5/95)

Dr. J. Franklin Kirkpatrick, Free Energy Secrets! (ca. 1960)

Samuel Glasstone and Milton C. Edlund, Nuclear Reactor Theory, D. Van Nostrand Co., Inc., Princeton, N. J. (1960)

Gustave Le Bon, The Evolution of Matter, (publisher unknown, c. 1890)

E. A. Moelwyn-Hughes, Physical Chemistry, Pergamon Press, N. Y., London, etc. (1965)

T. Henry Moray, The Sea of Energy in Which the Earth Floats (4th Ed., 1960), Cosray Research Institute, 2505 S. 4th St., Salt Lake City, Utah

Garrett P. Serviss (editor), Electricity and Magnetism, Popular Science Library (six-volume set), P. F. Collier & Son Corp., N. Y. (1941)

Howard M. Stainer, X-Ray Mass Absorption Coefficients, U. S. Dept. Of the Interior, Bureau of Mines (1963)

WORKS OF NIKOLA TESLA

Leland I. Anderson, editor, Bibliography: Dr. Nikola Tesla (1856-1943) (2nd Enlarged Ed., 1956), The Tesla Society, Minneapolis, Minn.

Thomas Commorford Martin, The Inventions, Researches and Writings of Nikola Tesla, The Electrical Engineer, New York (1894)

FBI Documents Regarding Nikola Tesla (232 pages released in the 1980s under the FOIA)

John T. Ratzlaff (compiler), Tesla Said, Tesla Book Company, Chula Vista, Ca.

Nikola Tesla, Colorado Springs Notes 1899-1900, Nolit, Beograd, Terasije 27, Yugoslavia (1978)

Nikola Tesla, Experiments with High Potential and High Frequency (New Ed.,

1979), Omni Publishers, P. O. Box 216, Hawthorne, Ca. 90250

Nikola Tesla, Lectures, Patents, Articles, Nikola Tesla Museum, Beograd, Yugoslavia (1956)

TESLA MAGAZINE AND NEWS ARTICLES

Dr. Nick Begich, New Uses of Tesla Technologies for Global Control, Extraordinary Science, Colorado Springs, Co., (Jan-Feb-Mar, 1995)

William L. Laurence, New York Times (Sept. 20, 1940)

Frank Parker Stockbridge, The Tesla Turbine, The World's Work (Mar., 1912)

Nikola Tesla, The Transmission of Electrical Energy Without Wires as a Means of Furthering Peace, Electrical World and Engineering (Jan. 7, 1905)

Nikola Tesla (Letter, Tesla to Westinghouse Co., July 7, 1912), microfilm, Library of Congress

Nikola Tesla (Letter), Some Experiments in Tesla's Laboratory with Currents of High Potential and High Frequency, Electrical Review of New York (1899)

Nikola Tesla (Letter), New York Times (Feb. 6, 1932), p. 16, col. 8.

TESLA BIOGRAPHIES

Margaret Cheney, Tesla, Man Out of Time, Prentice-Hall, Englewood Cliffs, N. J. (1981)

Inez Hunt and Wanetta W. Draper, Lightning in His Hand, The Life Story of Nikola Tesla, Omni Publications, Hawthorne, Ca. 90250

John J. O'Neill, Prodigal Genius, The Life of Nikola Tesla, David McKay Company, Inc., New York

TESLA'S DEATH RAY (Misc. References)

Nikola Tesla, Tesla's Startling Results in Radiography at Great Distances Through Considerable Thickness of Substances, Electrical Review of New York, Mar. 11, 1896.

Nikola Tesla, Tesla on the Hurtful Actions of Lenard and Röntgen Tubes, Electrical Review of New York, May 5, 1897

Grindell Matthews, Diabolic Rays, Popular Radio, Aug., 1924

The Death Ray Bobs up Again, Chicago Tribune, July 22, 1930

Tesla Discovered Death Ray in Experiments He made Here, Colorado Springs Gazette, May 30, 1934

Interview on New Death Beam; Portrait, New York Times, July 11, 1934

CREATIVITY, CAPITALISM, PHILOSOPHY & EPISTEMOLOGY

Bruce Bliven, The Analysis of Genius, Wisdom Magazine, Vol. 3 No. 25, May 1958

Eliot D. Hutchinson, How to Think Creatively, Abingdon Press, New York

Vera John-Steiner, Notebooks of the Mind, Harper & Rowe, New York

Jerome Kagan (editor), Creativity and Learning (an anthology), Beacon Press, Boston (1967)

Dr. Edgar Mayer, Genius and Prolonged Illness, Wisdom Magazine, Vol. 3, No. 25 (May, 1958)

Ayn Rand, The Fountainhead, The Blakiston Company, Philadelphia (1943)

Dagobert D. Runes, Pictorial History of Philosophy, Littlefield Adams & Co., Patterson, N. J. (1963)

INTELLIGENCE, CONSPIROLOGY, THE OCCULT & THE ILLUMINATI

Jean Michel Angebert, The Occult and the Third Reich, McGraw-Hill Book Company

James Bamford, The Puzzle Palace (1982)

E. A. Wallis Budge, The Egyptian Book of the Dead, Dover Publications, Inc., New York

John Roy Carlson, Undercover, The Blakiston Company, Philadelphia

Gregory Douglas, Gestapo Chief (three volumes), R. James Bender, P. O. Box 23456, San Jose, Ca. 95153

Jim Garrison, On the Trail of the Assassins, Warner Books, New York (1991)

Stephen Goode, The CIA, Franklin Watts, New York (1982)

G. Edward Griffin, World Without Cancer (Part I and II), American Media, Westlake Village, Ca (91350)

Charles Higham, Trading With the Enemy, Dell, 1983

Michael Howard, The Occult Conspiracy, Destiny Books, Rochester, Vt.

Theodore Ilion, Darkness Over Tibet, Adventures Unlimited Press, Box 22, Stelle, Illinois

William R. Lyne, Stealth I: De-Population by U.V. Immuno-Suppression, The Leading Edge, Issue No. 76 (Nov. 1994), Yelm, Wa.

John D. Marks, The Search for the "Manchurian Candidate" - The CIA and Mind Control, W.W. Norton & Co., New York/London

Victor Marchetti and John D. Marks, The CIA and the Cult of Intelligence, Dell Publishing Co., Inc., New York (1980-84)

G. R. S. Mead, Thrice Greatest Hermes, (Vol. 1-3), Hermes Press, Detroit

Hans Morgenthau, "Morgenthau's Pastoral Policy", (document authored by Morgenthau and presented to the Committee at Versaille, 1919, by Col. House), collected papers of President Lyndon Baines Johnson, L.B.J. School of Public Administration, Sid W. Richardson Research Center, U. T., Austin, Tx.

Cathy O'Brien and Mark Phillips, Trance-Formation of America, Reality Marketing, Inc., Las Vegas, NV (1995)

Louis Pauwels and Jacques Bergier, Morning of the Magicians, Stein & Day, Publishers, New York

Ronald Payne and Christopher Dobson, Who's Who in Espionage, St. Martin's Press, New York

Douglas Reed, The Controversy of Zion, The Noon tide Press, P. O. Box 1248, Torance, Ca. 90505

Abelard Reuchlin, The True Authorship of the New Testament, Abelard Reuchlin Foundation, Kent, Wa. 98064 (\$5.00)

Richard Sauter, Underground Bases and Tunnels (1995)

William R. Shirer, The Rise and Fall of the Third Reich, Fawcett Publications, Inc., Greenwich, Conn.

Christopher Simpson, Blowback, Weidenfeld & Nicolson, New York

Dr. Charles Sonnichsen, Alias Billy the Kid (1955)

William Stevenson, A Man Called Intrepid, Ballentine Books, New York

Tibetan Yoga and Secret Doctrines, Wentz Oxford U. Press, London

Jan Valtin (A. K. A. Hermann Julius William Krebs), Out of the Night, Alliance Book Corporation, New York (1941)

T. H. White, Once and Future King, Berkley Medallion Books, New York

W W II GERMAN/NAZI TECHNOLOGY, MISINFORMATION, AND PSEUDO-SCIENCE

Current Biography, 1939-52

Christof Friedrich, Germany's Antarctic Claim (Secret Nazi Polar Expeditions), Samisdat Publishers, Ltd., Toronto

Christof Friedrich, German Secret Weapons of WW II, Samisdat Publishers, Ltd., Toronto

Haarmann, D. H., Geheime Wunderwaffen. Hugon Gesellschaft Für Politisch-Philosophische Studien E. V., Hoerstel, Germany (1985)

W. A. Harbison, Projekt Saucer Book One: Inception*, Dell, N. Y. (1991)

Heinz Knocke, I Flew for the Führer

Rudolf Lusar, German Secret Weapons of the Second World War, Neville Spearman, London (1960)

W. Mattern, UFO's - Last Secret Weapons of the Third Reich?, Samisdat Publishers, Ltd., Toronto

Jorge Resines, Secret of the Schauberger Saucer**, Borderland Sciences, Garberville, Ca. (1988)

Heinz Schaeffer, U-Boat, Ballentine, N.Y.

Henry Stevens, Report No. 1, Report No. 2, German Research Project, P. O. Box 7, Gorman, Ca. 93243-0007

Henry Stevens, Report No. 3, Rumored German Wonder Weapons, Fantastic German Submarines, German Research Project, Gorman, Ca. (1996)

John Toland, Ships in the Sky, Henry Holt & Co., N.Y.

Vladimir Terziski, Close Encounters of the Foo Fighter Kind***, T. R. Z. Consultants, Los Angeles (1994)

Vladimir Terziski, UFO Secrets of the Third Reich*** (video), T. R. Z. Consultants, Los Angeles (1994)

Icirus Productions, Top Secret German UFO Cover-Up*** (video)

UFOs and Star Wars*** (video), Adventures Unlimited, 303 Main St., Kempton, Illinois

* - misinformational

** - misconceptual

*** - misinformational/misconceptual

LINGUISTICS & ANCIENT HISTORY

Linus Bruner, Malayo-Polynesian Vocabulary with Semitic and Indo-European Roots, Occasional Publications (Vol. 10 Part 2), The Epigraphic Society, 6625 Bamburgh Drive, San Diego, Ca. 92117

Otto Benesch, Art of the Northern Renaissance

L. Sprague de Camp, Lost Continents, Dover, N.Y. (1970)

Iron Thunderhorse, The Mysterious Dawnlanders, Ancient American, Issue #19/20 (July-Oct, 1992)

Kathleen Kenyon, Archaeology of the Holy Land, Praeger Publishers, New York

Plotinus, Secret History of the Byzantine Emperors

N.K. Sandars, The Sea Peoples, Thames & Hudson, N.Y.

PROPAGANDA AND PSYCHOPOLITICS

Bill Barry, Kidnapped, Penthouse Magazine (c. 1978)

Walter Bowart, Letter to Walter Bowart from Julianne McKinney (Director of the Electronic Surveillance Project of the Assn. Of Nat. Security Alumni), Silver Springs, Md. (June 16, 1994)

Giant Comics, U.F.O. Flying Saucers, Western Publishing Company (1968)

Frank Edwards, Flying Saucers - Serious Business, Bantam, N. Y. (1966)

Jacques Ellul, Propaganda - The Formation of Men's Attitudes, Vintage Books, New York

Adolf Hitler, Mein Kampf, Houghton-Mifflin, Boston

Hunter, "Brainwashing", (unlocatable, though primary book on subject)

Dino de Laurentis (film producer), Horst Wentlandt (associate producer), The Serpent's Egg (film)

John Spencer, The UFO Encyclopedia, Avon Books, N.Y. (1991)

Duane Thorin, A Ride to Panmunjom, Henry Regnery Company (1956)

Gladys & Marcella Thum, The Persuaders: Propaganda in War and Peace, Atheneum, New York (1974)

APPENDIX "A" - Giving to the Public the Dvna-Lvne Universal Variable Pneumatic or Hydraulic Transmission System

ABSTRACT

A variable, rotary power, pump-type transmission, in either hydraulic or pneumatic embodiment, which combines positive and negative displacement pumping effects, transferring work energy to the medium as differential pressure and heat, which are interconverted through an externally reversible process, into continuous output torque, thermodynamically or adiabatically. Prime mover power, applied to the pump drive shaft and interconnected driving member, is delivered as interconverted power at the output shaft, interconnected to the body and driven pumping mechanisms; in the thermodynamic process, thermal equilibrium is maintained by pressure and heat exchange within the transmission and the medium flowing in closed loop-circuits, through the valves, which maintain the unequal pressure and temperature built up between the negative and positive displacement cavities; in the adiabatic process, work energy pressure differentials are transmitted immediately through the incompressible hydraulic medium, by compression and vacuum pumping phases, into output torque, in exchanges of pressure through the valves. The dynamic integral valves, actuated by an external stationary positioner, determine conversion ratios under given conditions of input horsepower and r.p.m., and output load, by maintaining specific, adjustable, positive and negative differences of pressure and temperature, which proportionately impart rotational force in the same direction to the output shaft, via the interconnected body and driven pumping mechanisms, from zero r.p.m., with valves fully opened and internal mechanisms and medium freely moving, to 1:1 ratio with valves closed and medium and internal mechanisms in virtual arrest.

(NOTE: In a 3/5/92 request for amendment, not reflected in the drawings, but reflected in the amended description, the dynamic valve actuator tubes---30 of FIG 1, and 83 of FIG 4---are completely eliminated, in conformance to my original Disclosure Document of June 5, 1987, by placing the same female-splined valve actuator flange 34 of FIG 1, on both splined output shafts 20 for FIG 1, and 90 of FIG 4. Fluid and annular channels 69 of FIGS 4 and 5, embodiment 1a, were accordingly redesigned as follows:

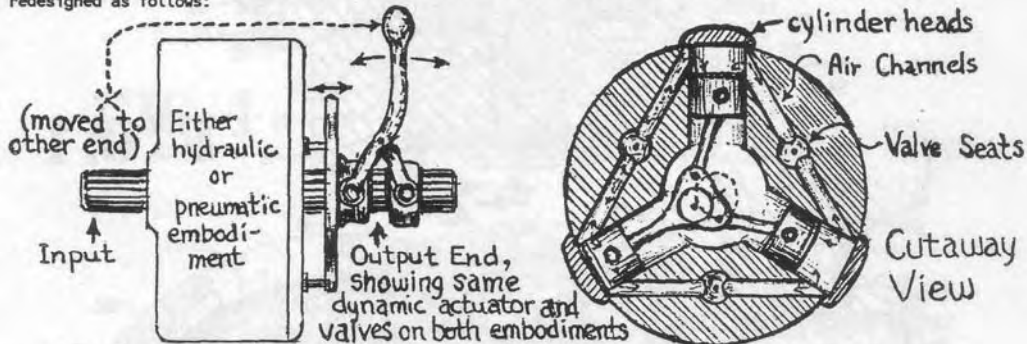

© WJ 1993

Pneumatic Embodiment 1a shown

Not shown in the request for amendment or drawings, the two different valve plungers---17 of FIG 1, and 68 of FIG 4---should be replaced with the same 'push-pull'-type tapered plungers and seats, on both embodiments 1 and 1a, as follows:

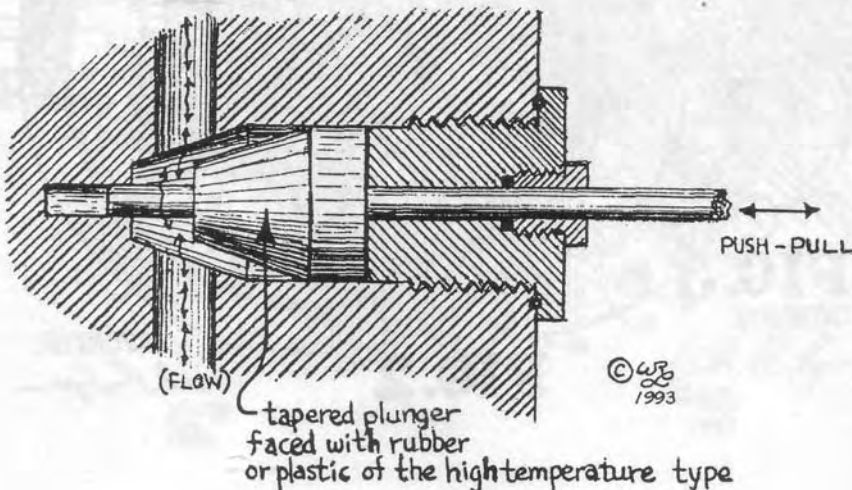

tapered plunger faced with rubber or plastic of the high-temperature type

DRAWINGS

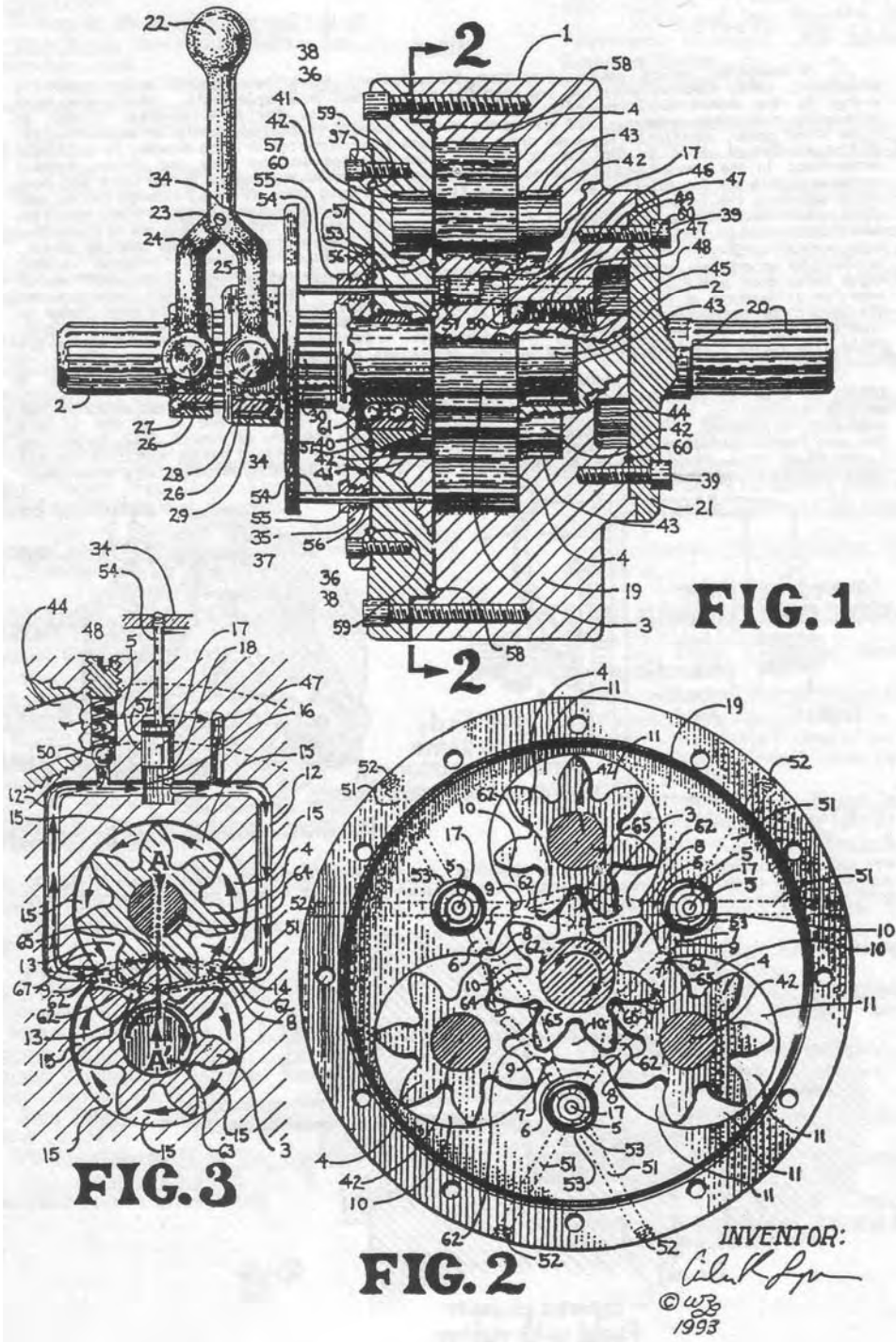

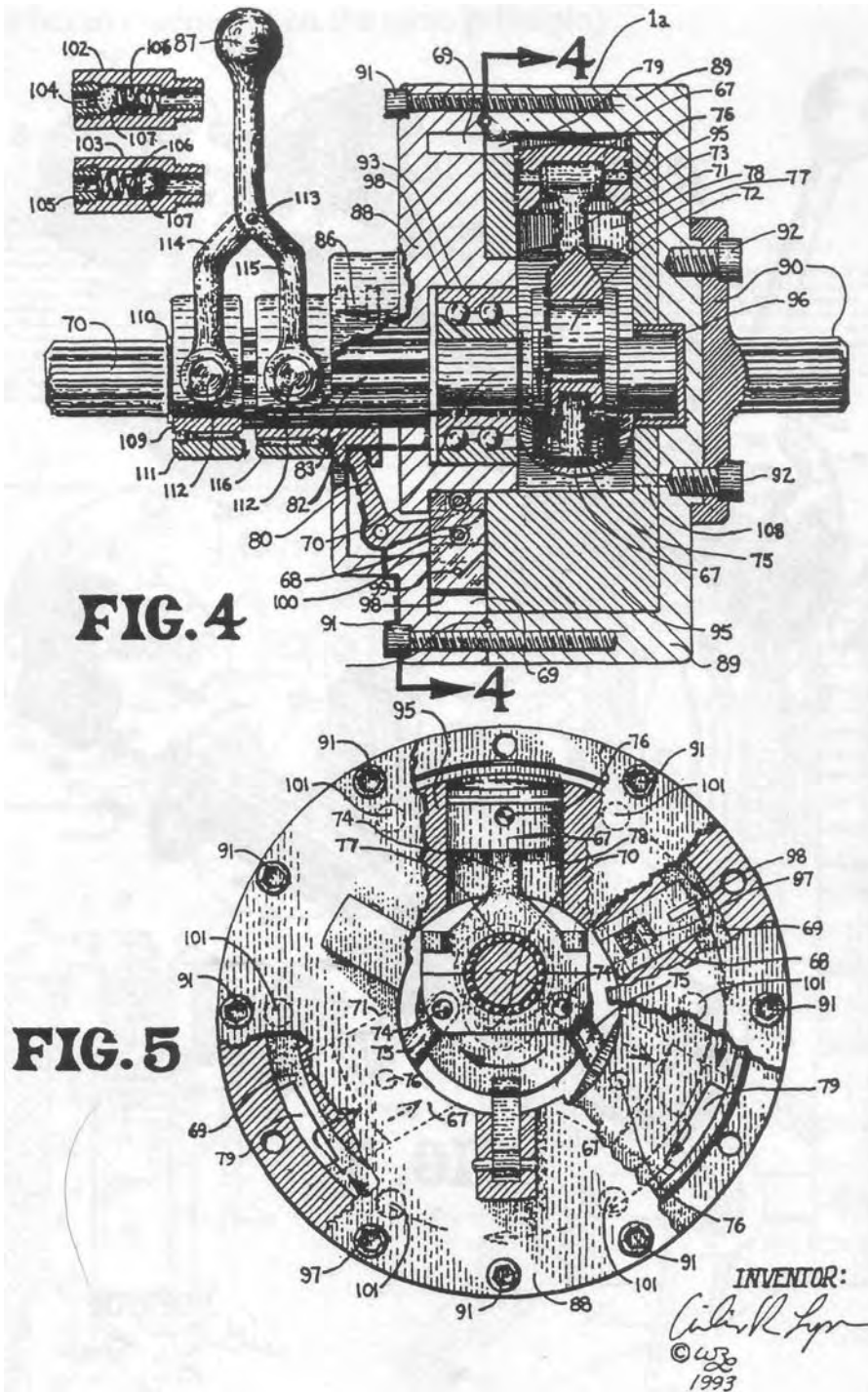

ALIENS295

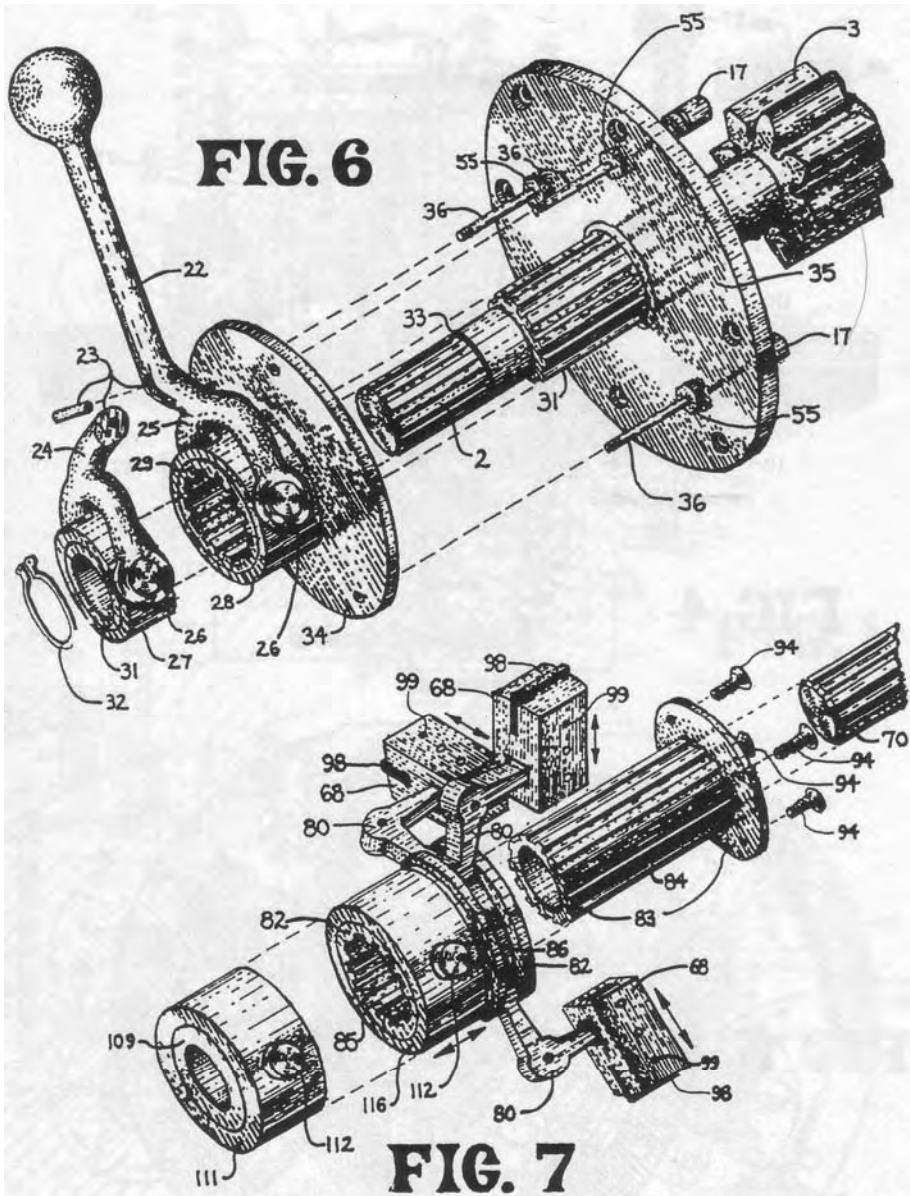

INVENTOR:
Winkler
 © W.S.
 1993

APPENDIX "B" - The Papp Patent for the Conversion of Atomic Energy into Utilizable Kinetic Energy (with an excerpt from the Britt Patent based essentially on the same principle):

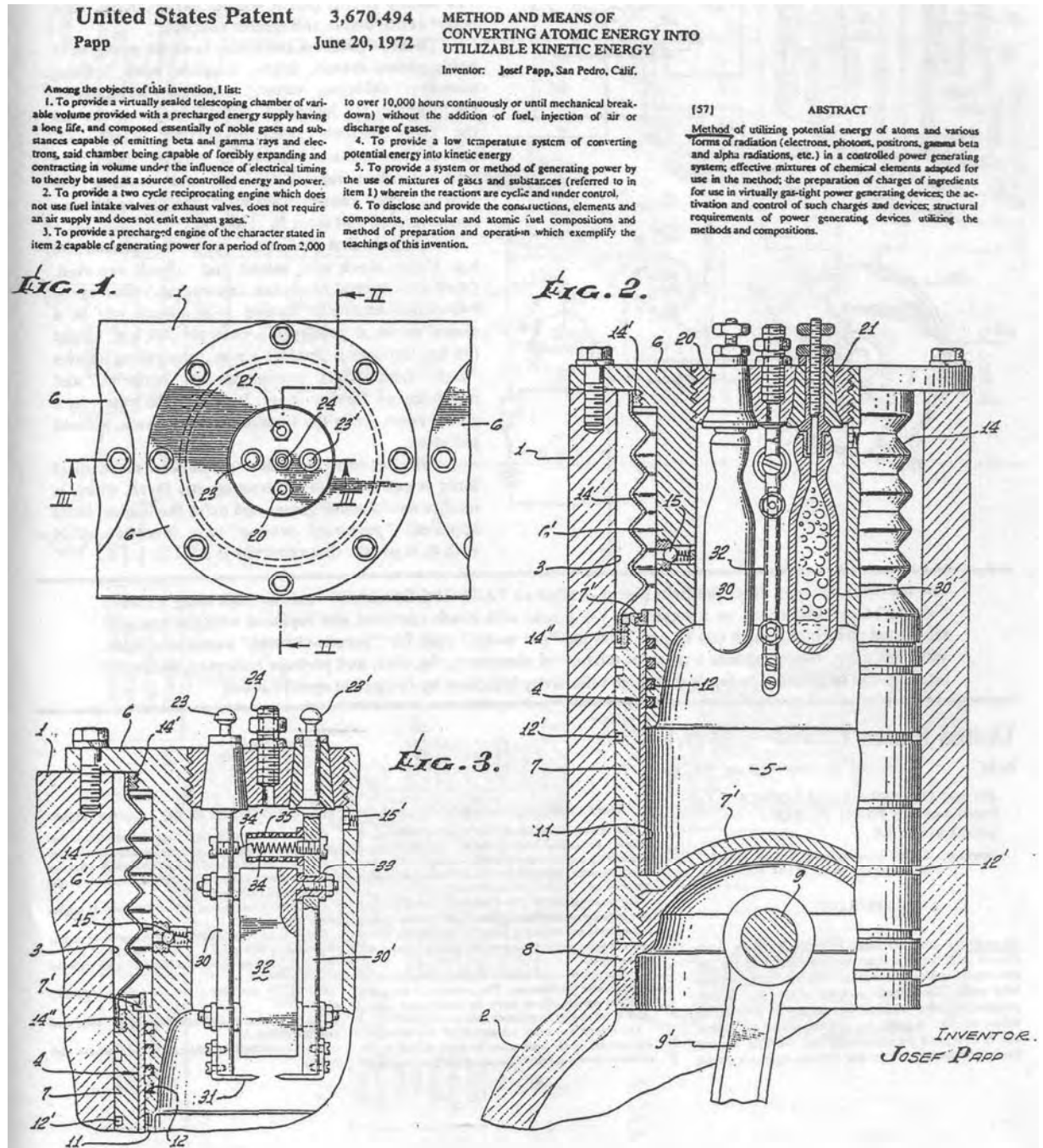
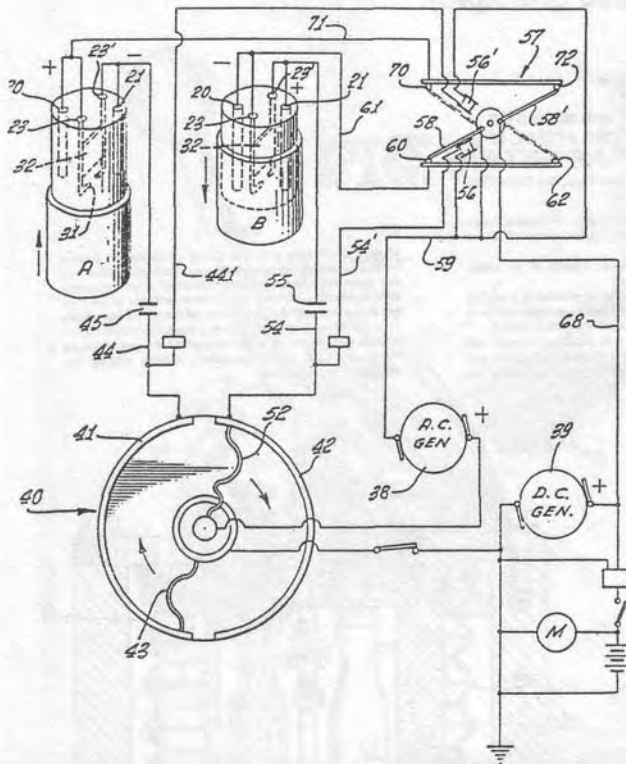

FIG. 4.



These two related patents somehow miraculously slipped through the patent office without national security orders. The first (Papp) patent was unnecessarily complicated, probably because Papp was Hungarian, and worked through an interpreter. The second (Britt) patent was an improvement, with better construction and clearer concept.

These engines use electricity to excite mixtures of noble gasses (xenon, argon, krypton, neon, helium, mercury, chlorine, water, rubidium, phosphorus, etc.), though the inventors' criteria indicates that all the "light elements" below atomic No. 19 are well-suited. The gasses expand in excited states and contract when relaxed, driving and 'sucking' the pistons. After considerable wear, the gasses become contaminated and must be changed.

Papp's first prototype was a four-cylinder, 90 h.p. Volvo block with intake and exhaust removed, fitted with special heads (an "air-cooled, closed cycle, two-stroke engine"). During a 35-minute test in a closed room, it produced a constant 300 h.p. output (75 h.p./cylinder), @ 4,000 r.p.m., generating its own "fuel" (electricity), recharging its batteries, and requiring no further input. It runs underwater, in a closed room, or in the vacuum of outer space, without pollution.

Similar to flying saucer propulsion, mechanical force is converted to electromagnetic force, which is used to excite noble gasses and drive the engine, in an apparent "perpetual motion"-type invention. Deal with it. It proves that relativity is a BIG LIE.

The following excerpts from the Britt patent—called an "AEROPS ENGINE"—can be built using a Chevy "Monza" 6-cylinder block, or a 4-cylinder VW block, with heads removed and replaced with the specially fabricated chambers, which can be cast from the "pot metal" used for "pseudo-chrome" automotive trim. With this alloy, which contains a pleasant mixture of aluminum, tin, zinc, and perhaps antimony, the cavity interiors can be polished to the desired high reflectivity indicated by the patent specifications.

United States Patent 3,977,191

Britt

Aug. 31, 1976

ATOMIC EXPANSION REFLEX OPTICS
POWER OPTICS POWER SOURCE
(AEROPS) ENGINE

Inventor: Robert Gordon Britt, 313 W. Fisher
St., Salisbury, N.C. 28144

ABSTRACT

An engine is provided which will greatly reduce atmospheric pollution and noise by providing a sealed system engine power source which has no exhaust nor intake ports. The engine includes a spherical hollow pressure chamber which is provided with a reflecting mirror surface. A noble gas mixture within the chamber is energized by electrodes and work is derived from the expansion of the gas mixture against a piston.

BRIEF OBJECTIVE OF THE INVENTION

This invention relates to the development of an atomic expansion reflex optics power source (AEROPS) engine, having the advantages of greater safety, economy and efficiency over those disclosed in the prior art.

The principal object of this invention is to provide a new engine power technology which will greatly reduce atmospheric pollution and noise, by providing a sealed system engine power source which has no exhaust nor intake ports.

Engine power is provided by expanding the atoms of various noble gas mixtures. The pressure of the gases increases periodically to drive the pistons and crankshaft in the engine to produce safe rotary power.

The objects and other advantages of this invention will become better understood to those skilled in the art when viewed in light of the accompanying drawings.

BRIEF DESCRIPTION OF THE DRAWING VIEWS

Other objects, advantages and features should become apparent from the following disclosure wherein:

FIG. 1 is an elevational view of the hollow spherical pressure chamber assembly, including sources of gas mixtures and electrical supply.

FIG. 2 is an elevational view of the primary engine power stroke.

FIG. 3 is an elevational view of the primary engine compression stroke.

FIG. 4 is a rear elevational view of a six cylinder AEROPS engine.

FIG. 5 is a top view of the six cylinder AEROPS engine.

FIG. 6 is an electrical schematic of the source of medium voltage.

FIG. 7 is an electrical schematic of the source of high voltage.

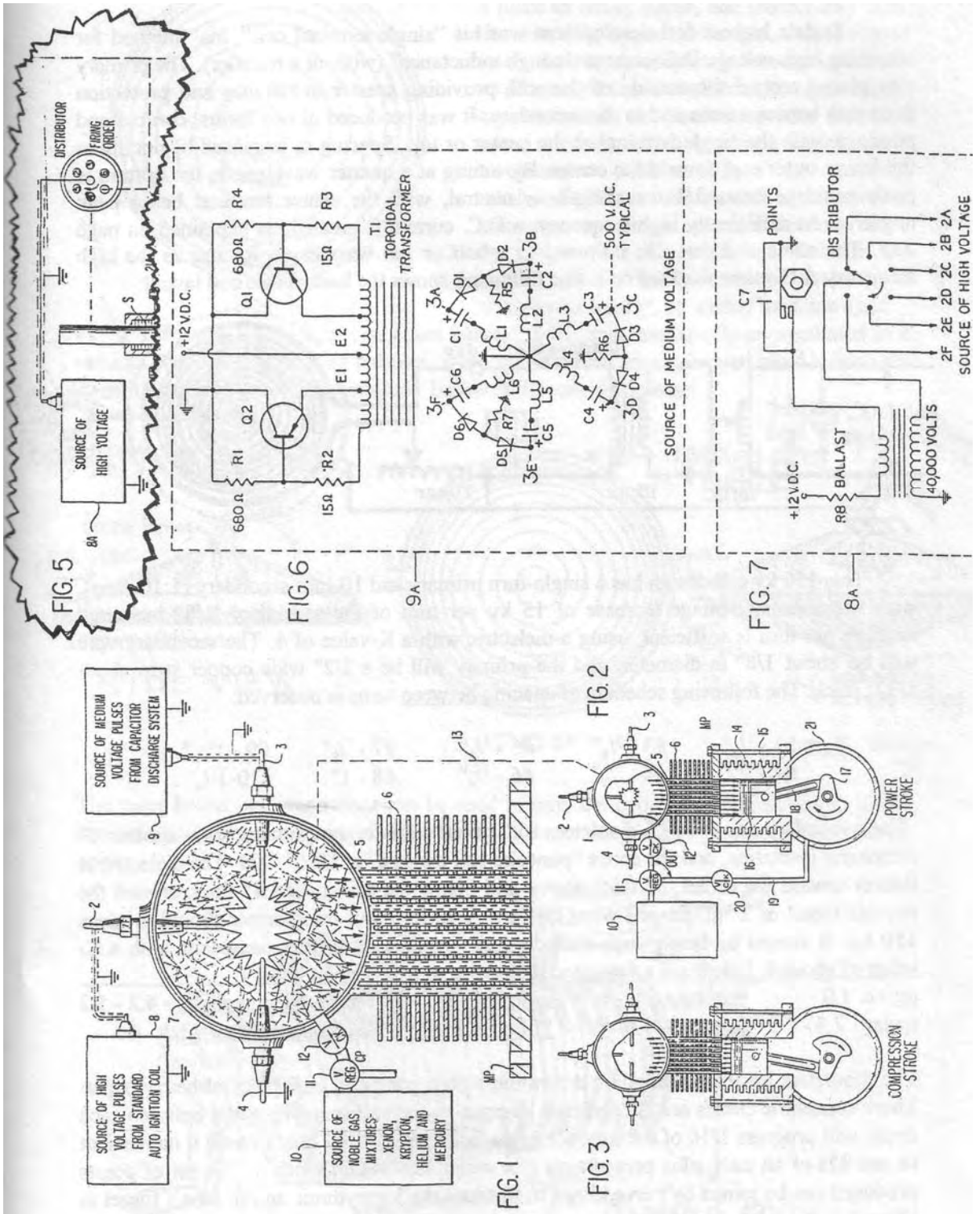

ALIENS299

APPENDIX "C" - Fabrication of Tesla's Single Terminal Coils

Tesla's highest coil development was his "single terminal coil", his "method for obtaining high voltage D.C. current through inductance" (without a rectifier). The primary was placed around the outside of the coil, providing greater inductance and protection from arcs between turns and to the secondary. It was produced in two forms, conical and pancake, with the single terminal at the center or top. Spacing is increased beginning at the lower outer end, toward the center. By tuning at a quarter wavelength, the bottom is peak positive, or at 3/8 wavelength, is neutral, with the center terminal being peak negative. At sufficiently high frequency, a D.C. current is created, as explained on page 216. The same coil can also be tuned to a half or full wavelength for use as the high frequency A.C. ether blocking coil. The following shows the basic Tesla coil layout:

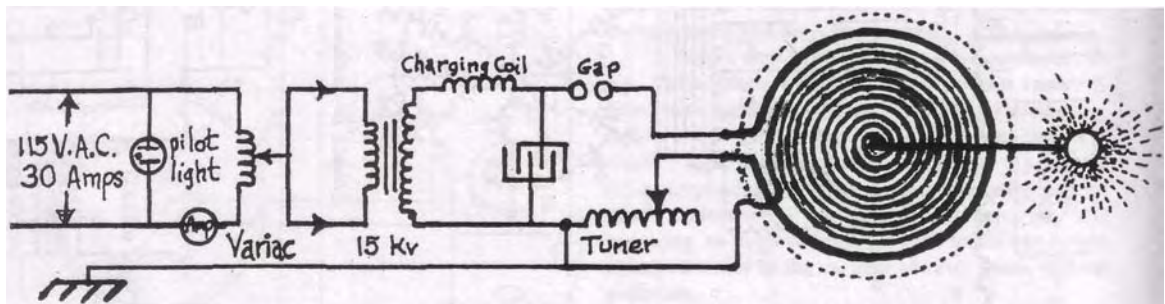

This 150 kv coil design has a single-turn primary and 10-turn secondary (1:10 ratio), with a maximum voltage increase of 15 kv per turn of the secondary. 1/8" increased spacing per turn is sufficient, using a dielectric with a K-value of 4. The secondary wire will be about 1/8" in diameter, and the primary will be a 1/2" wide copper strip about 1/32" thick. The following schedule of spacing between turns is observed:

Turn #1 - 1/8"	#3 - 3/8"	#5 - 5/8"	#7 - 7/8"	#9 - 1 1/8"
#2 - 1/4"	#4 - 1/2"	#6 - 3/4"	#8 - 1"	#10 - 1 1/4"

The secondary has a 16 1/4" diameter. 1/2" outside this is the primary, with another 1" peripheral insulation, and the entire "pancake coil capsule" is 19 1/4" O.D. The dielectric is thicker toward the center, 3" thick above and below the center, and 1" thick around the outside (total of 2" at dia. and 6" at center). A 15 kv input transformer should produce 150 kv. It should be firmly cast, excluding air, inside a resin/fiber composite with a K-value of about 4. Below are a few good dielectrics to give you an idea: _____

air-c. 1.0 neoprene - 4. - 6.7 silicone-3.2-4.7 mica-filled phenolic - 4.2 - 5.2
 mylar - 7.3 - 9.3 formica - 3.6 - 6. "fiber" - 5. cellulose acetate-3.1 - 4.5

The diameters for the 10 turns are drawn out with a compass, on a piece of heavy paper. These concentric circles are divided into 16 equal radial sections. The spiral between each circle will progress 1/16 of the total for each section, per radial line. I found it convenient to use 32s of an inch, plus percentages (for example, "18.25/32nds"). The set of points produced can be joined by curved lines to produce the logarithmic spiral. Don't forget to allow for the thickness of the wire, compensated for by moving the schedule up a 1/8" thickness from the bottom. The wire thickness is then drawn on the outer side of the spiral

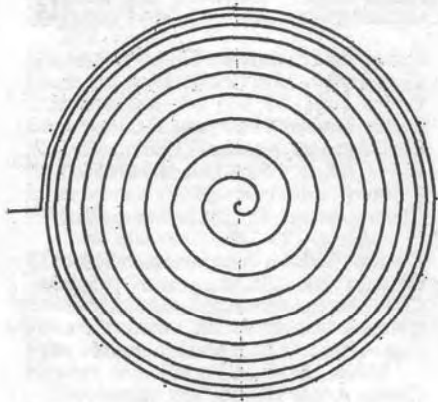

coming out with a 1/8" space at turn #1, and 1.25" space at turn #10. Transfer the spiral to a piece of heavy paper, and temporarily affix the wire. The upper side is cast, then is turned over, the paper completely removed, and the mold used to cast the other side, again taking care to exclude air. Don't whip your dielectric when mixing, which produces unnecessary, troublesome bubbles. There are castable, catalyzed silicone rubbers with high dielectric constants, requiring no vulcanization, made by people like Dow-Corning. Enlarge the spiral which I have drawn to scale, to a diameter of 16.25", on a copy machine (use

11" x 17" paper, doing it in two equal halves). Such coils are usually encapsulated in a vacuum chamber, eliminating bubbles of air, while an electrically-heated mold vulcanizes something like a hard-rubber mixture. Below is the casting process:

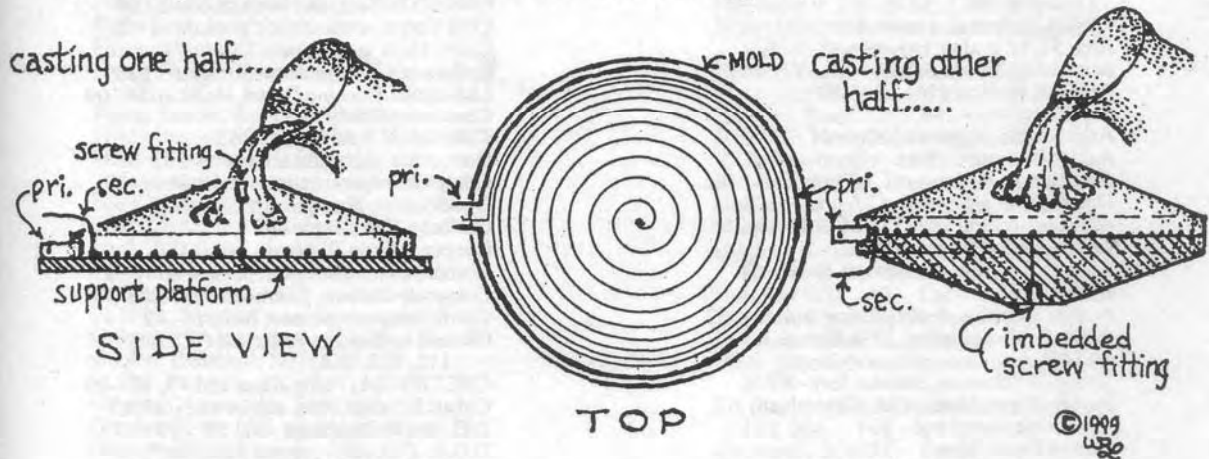

The tuner below, and capacitors can be used to tune the coil. The physical length of the secondary wire is about one-quarter of a 1 MHz wavelength, as an approximate starting point.

